

FH-26664-000

SHT 1.1

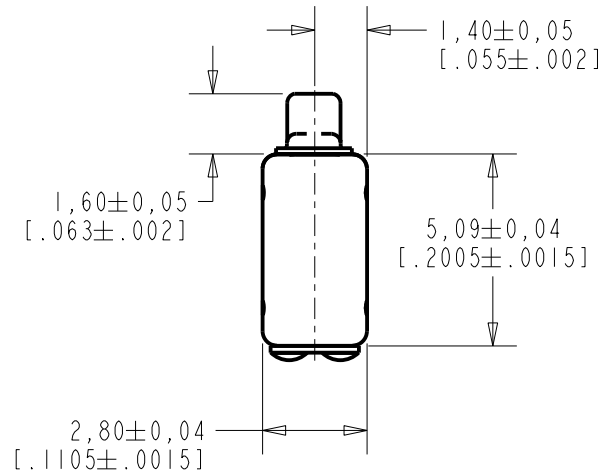

NOTES:

- 1 LOCATED FROM TWO SURFACES FOR CUSTOMER CONVENIENCE. ONLY APPLICABLE FROM ONE SURFACE, NOT TO BE USED TOGETHER. HORIZONTAL LOCATION FOR TERMINAL CENTERED TO $\pm 0,17$ [.007].
- 2 A POSITIVE GOING VOLTAGE AT TERMINAL 2, RELATIVE TO TERMINAL 1, CAUSES A DECREASE IN PRESSURE AT THE SOUND OUTLET.

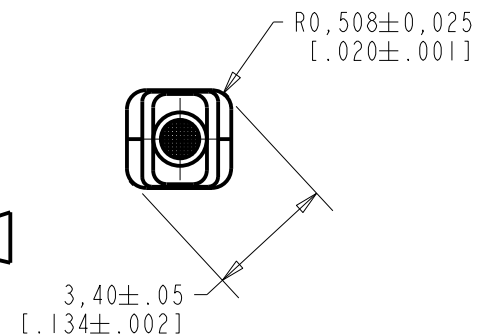
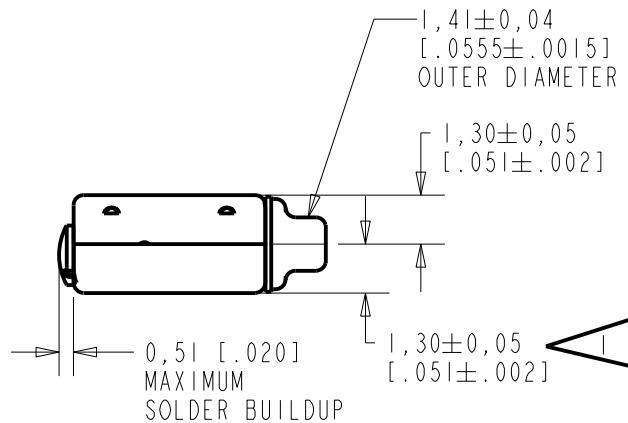
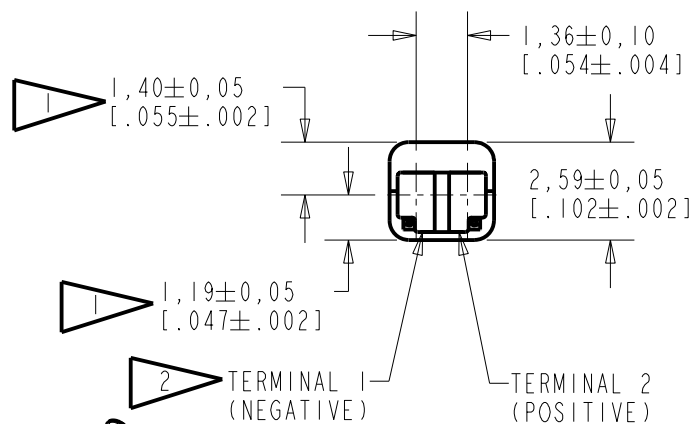

SCALE 2:1

NOMINAL WEIGHT
.18 GRAMS

DIMENSIONS IN MILLIMETERS [INCHES]

Revision	C.O. #	Implementation Date	RELEASE LEVEL	REVISION
B	C10112870	11-4-11	Active	B
A	C10103105	9-15-05		

SCALE: 5:1	DR. BY DATE
DO NOT SCALE DRAWING	MMM 9-15-05
TITLE: RECEIVER	CK. BY DATE
OUTLINE DRAWING	GJP 9-20-05
FH-26664-000	APP. BY DATE
SHT 1.1	GJP 9-20-05

KNOWLES ELECTRONICS
ITASCA, ILLINOIS U.S.A.

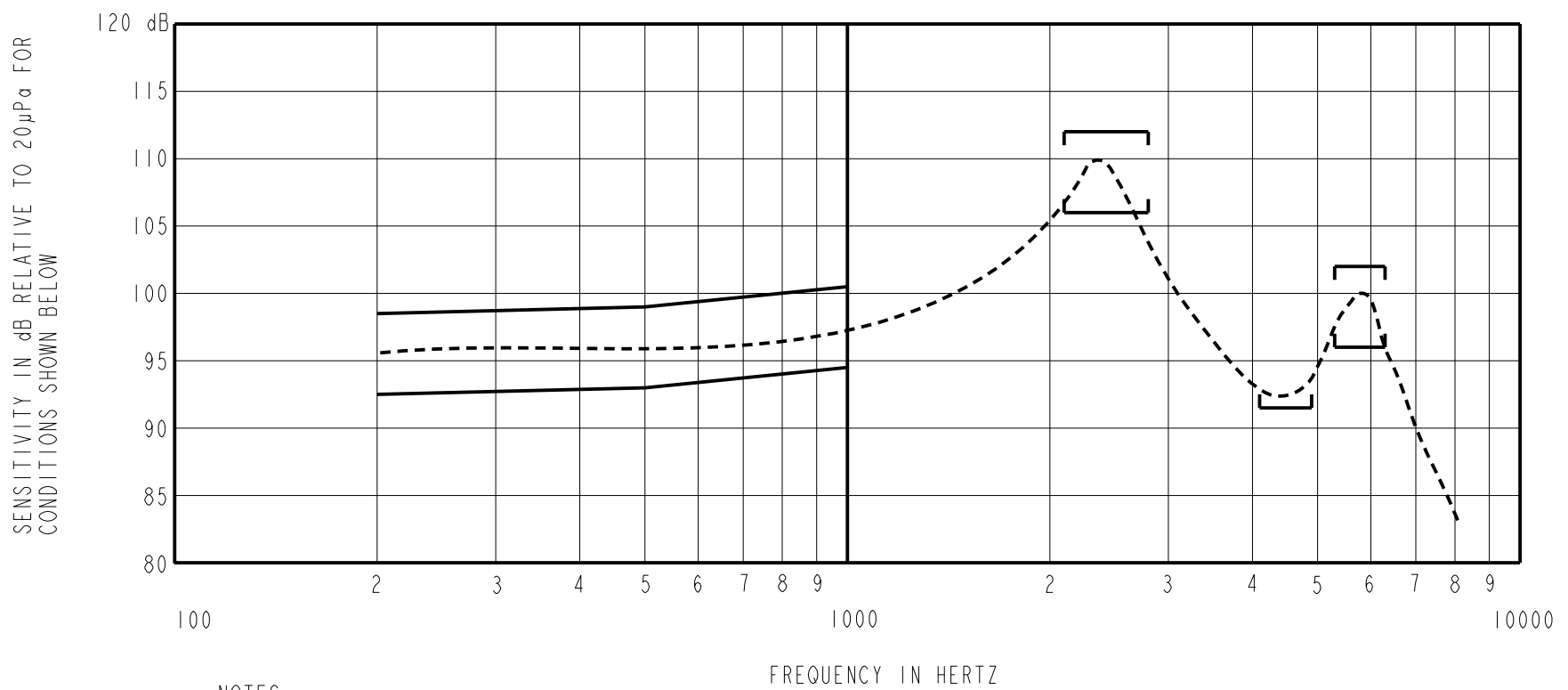

NOTES:

1. MEASUREMENTS MADE USING 10mm (.394") OF 1mm (.039") ID TUBE CONNECTED TO A SIMULATED ANSI S3.7 TYPE HA-3 COUPLER. (IEC 60318-5)

2. SENSITIVITY

FREQUENCY	MIN.	MAX.
200	92.5	98.5
500	93.0	99.0
1000	94.5	100.5
2100-2800	106.0	112.0
4000-4800	91.5	---
5300-6300	96.0	102.0

- 3. RESPONSE, IMPEDANCE, AND DISTORTION MEASUREMENTS MADE USING THE ELECTRICAL TEST CONDITIONS SHOWN BELOW.
- 4. ELECTRICAL SOURCE INPEDANCE MUST BE GREATER THAN 20 TIMES 1kHz IMPEDANCE FOR TEST CONDITIONS SHOWN BELOW.
- 5. INDIVIDUAL SPECIFICATIONS.

PORT LOCATION	IMPEDANCE OHMS ±15%		DCR @20°C OHMS ±10%	DISTORTION		ELECTRICAL TEST CONDITIONS	
	1KHz	500Hz		MAX. %	FREQ Hz	AC mA RMS	DC mA
12S	790	560	444	5	750	0.62	0.00

Revision	C.O. #	Implementation Date	RELEASE LEVEL	REVISION
B	C10112870	11-4-11	Active	B
A	C10103105	9-15-05		

KNOWLES ELECTRONICS
ITASCA, ILLINOIS U.S.A.

WHEN TEST LIMITS ARE USED TO ESTABLISH INCOMING INSPECTION ACCEPTANCE/REJECTION CRITERIA, CORRELATION OF TEST EQUIPMENT WITH KNOWLES IS ALSO REQUIRED FOR ELIMINATION OF EQUIPMENT AND TEST METHOD VARIATION

TITLE: **RECEIVER** FH-26664-000
PERFORMANCE SPECIFICATION SHT 2.1

DR. BY	DATE
MMM	9-15-05
CK. BY	DATE
GJP	9-20-05
APP. BY	DATE
GJP	9-20-05