

ANT-433-CW-RH

Data Sheet

Product Description

The RH Series utilizes a helical element to greatly reduce the physical length of the antenna housing. They are ideal for small products where cosmetic or functional requirements dictate a compact, aesthetically pleasing antenna package. Despite their tiny size, RH Series antennas are ruggedly constructed and able to withstand punishing environments just like our larger whips. RH Series antennas attach via an SMA or Part 15 compliant RP-SMA connector.

Features

- Reduced-height helical whip
- Excellent performance
- Omni-directional pattern
- Low VSWR
- Fully weatherized
- Rugged & damage-resistant
- SMA or Part 15 compliant RP-SMA connector
- Available in black or custom colors
- Use with plastic* or metal enclosures

* Requires proximity ground plane

Electrical Specifications

Center Frequency:	433MHz
Recom. Freq. Range:	425–440MHz
Wavelength:	1/4-wave
VSWR:	< 1.9 typical at center
Peak Gain:	–5.6dBi
Impedance:	50-ohms
Oper. Temp. Range:	–40°C to +90°C
Connector:	RP-SMA or SMA

Electrical specifications and plots measured on 10.16 cm x 10.16 cm (4.00" x 4.00") reference ground plane

Ordering Information

- ANT-433-CW-RH (with RP-SMA connector)
- ANT-433-CW-RH-SMA (with SMA connector)

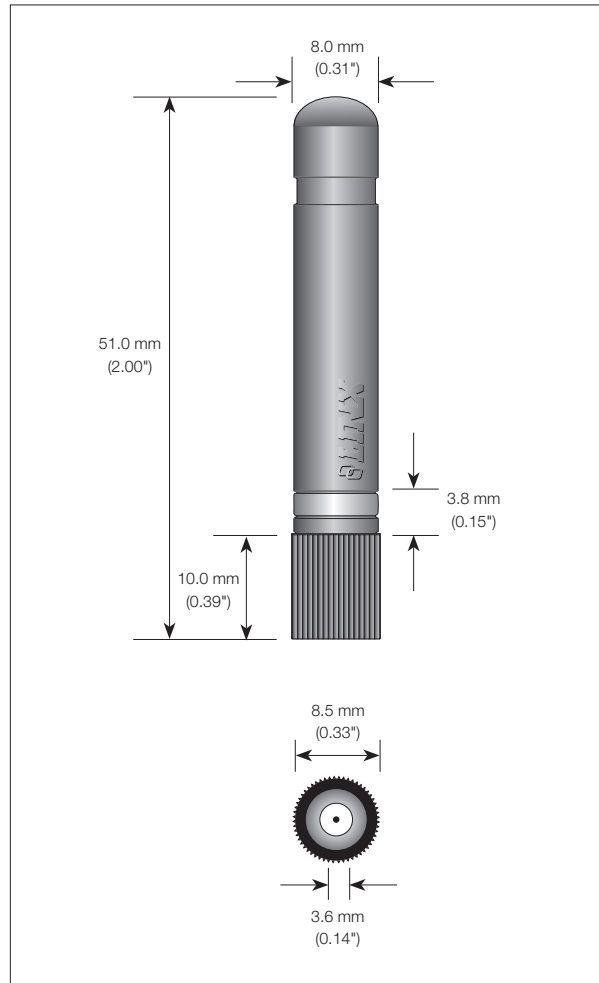

Counterpoise

Quarter-wave or monopole antennas require an associated ground plane counterpoise for proper operation. The size and location of the ground plane relative to the antenna will affect the overall performance of the antenna in the final design. When used in conjunction with a ground plane smaller than that used to tune the antenna, the center frequency typically will shift higher in frequency and the bandwidth will decrease. The proximity of other circuit elements and packaging near the antenna will also affect the final performance. For further discussion and guidance on the importance of the ground plane counterpoise, please refer to Linx Application Note AN-00501: Understanding Antenna Specifications and Operation.

VSWR Graph

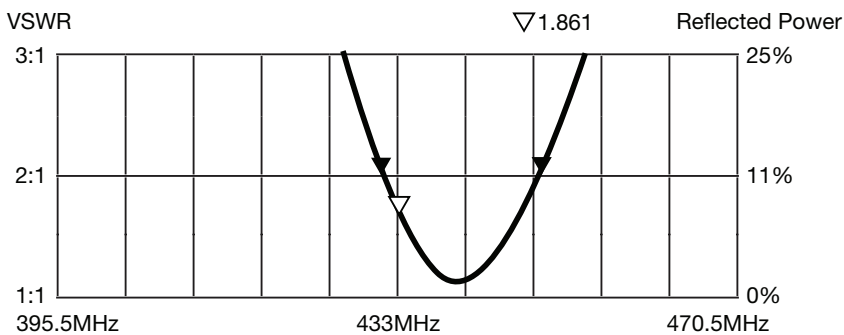

What is VSWR?

The Voltage Standing Wave Ratio (VSWR) is a measurement of how well an antenna is matched to a source impedance, typically 50-ohms. It is calculated by measuring the voltage wave that is headed toward the load versus the voltage wave that is reflected back from the load. A perfect match will have a VSWR of 1:1. The higher the first number, the worse the match, and the more inefficient the system. Since a perfect match cannot ever be obtained, some benchmark for performance needs to be set. In the case of antenna VSWR, this is usually 2:1. At this point, 88.9% of the energy sent to the antenna by the transmitter is radiated into free space and 11.1% is either reflected back into the source or lost as heat on the structure of the antenna. In the other direction, 88.9% of the energy recovered by the antenna is transferred into the receiver. As a side note, since the “:1” is always implied, many data sheets will remove it and just display the first number.

How to Read a VSWR Graph

VSWR is usually displayed graphically versus frequency. The lowest point on the graph is the antenna’s operational center frequency. In most cases, this will be different than the designed center frequency due to fabrication tolerances. The VSWR at that point denotes how close to 50-ohms the antenna gets. Linx specifies the recommended bandwidth as the range where the typical antenna VSWR is less than 2:1.