

SmartRadio Telemetry Module

Features

- 8 Channel transceiver module
- Range up to 1,000 metres
- 8 Digital input/outputs
- Receiver outputs mirror transmitter inputs
- Minimal external components
- Secure data protocol
- Ultra low power 1.8—3.6V
- Easy pairing process
- One to one and one to many operation
- 869.5 / 915MHz operating versions
- +13dBm transmit power
- Single in line module
- Incorporates Self Test Mode
- CE compliant for licence free use
- FCC Approved for use in USA

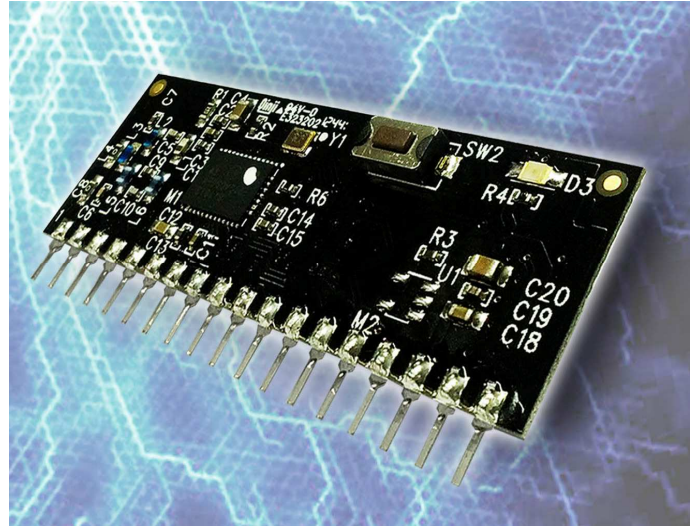

Applications

- Remote Control
- Remote Networking
- Remote Switching
- Remote Traffic Lights

The BRAVO-T telemetry module provides a reliable transceiver based industrial remote switch with up to 1,000 metres range. Two or more modules may be combined to provide a simple or complex network of radio switches.

Part No	Description
BRAVO-T868	Radio telemetry module SIL package 868MHz
BRAVO-T915	Radio telemetry module SIL package 915MHz

Pin-out

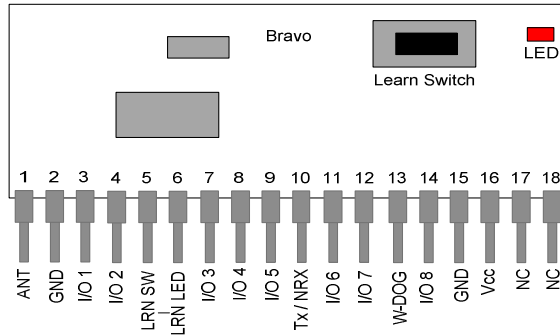

Pin Description

Pin No	Name	Direction	Description
1	ANT	In	Antenna input/output 50ohm impedance
2, 15	GND	In	Connect to ground
3, 4, 7, 8, 9, 11, 12 14	I/O1-8	In / Out	When configured as transmitter:Active low Digital inputs: high impedance inputs When configured as receiver: Active High Digital outputs: LVCMOS output drive
5	LRN SW	In	Learn switch input: Normally 'high' momentary connect to Ground to enter Learn Mode. If on board switch or to be used this input can be left unconnected
6	LRN LED	Out	Optional LED drive output Mirrors on-board LED
10	TX/RX	In	Connect to Vcc : Module is a transmitter Connect to GND : Module is a receiver
13	W-DOG	In / Out	Transmitter= Input Connect to Vcc : Watchdog is disabled Connect to GND : Watchdog is enabled Receiver= Output High : Watchdog is healthy Low : Watchdog Fault!
16	Vcc	In	Supply voltage
17,18	N/C	N/A	Leave unconnected

General description of operation

Each module can be set to act as a 'transmitter' or 'receiver' A telemetry system is achieved when two modules are paired together, as transmitter (BRAVO-Tx) and receiver (BRAVO-Rx). Each time any input changes on the BRAVO-Tx, it will transmit the status of ALL inputs to the paired BRAVO-Rx(s). The BRAVO-Rx(s) which will set their outputs to match the BRAVO-Tx inputs. After each state change the modules will return to sleep mode.

Note: All of the 8 channels are common to all modules in a system

Example: If you are using a system with two or many Bravo modules each channel be will common to all modules ie. if you change state on transmitter input 8, then all receiver output 8's will also change state.

BRAVO Configured as a TRANSMITTER

1. Operation

When configured as a transmitter the BRAVO module will automatically default to low power sleep mode until any input state change takes place.

On receipt of an input state change the BRAVO-Tx will transmit a packet showing the state of all inputs at the time of the change (multiple input changes may take place simultaneously)

1.1 Watchdog

If watchdog is enabled the Bravo-Tx will transmit a background packet containing the current status of the inputs every 5 minutes.

1.2 Digital Inputs

High impedance inputs, LVCMOS / LVTTTL compatible, 5V tolerant.

Can be connected directly to CMOS/TTL logic or switch inputs connected to 0V or VCC
A change on the input will cause the BRAVO-Tx to wake, read all inputs and initiate RF transmission.

Transmitter Application circuit example

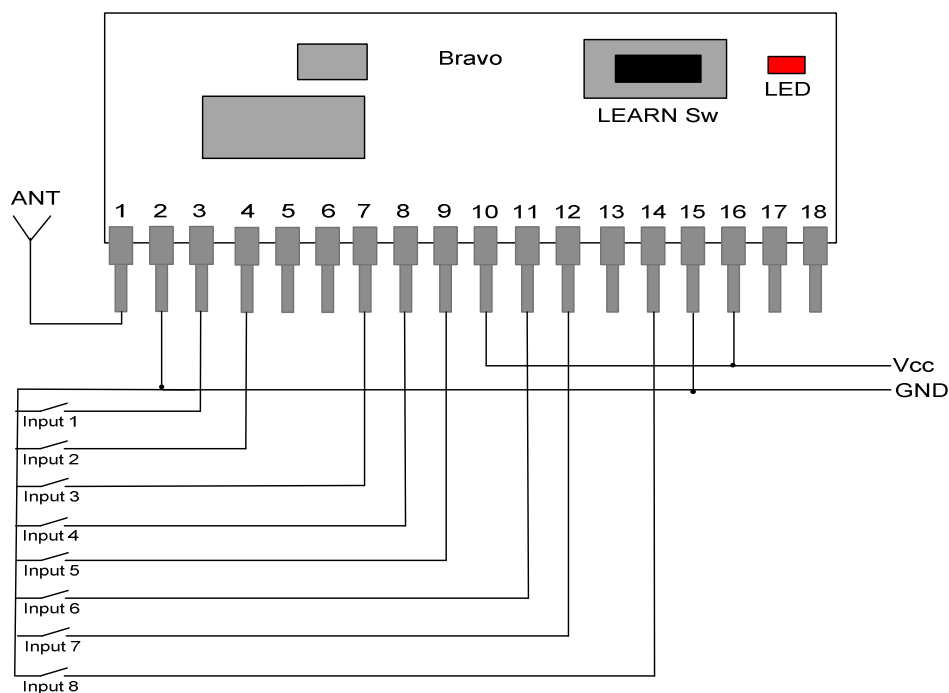

Description:

This example shows a BRAVO module configured as a transmitter with all 8 inputs connected and watchdog disabled.

Notes:

All input switches would need to be connected to GND to activate.

BRAVO Configured as a RECEIVER

1. Operation

When configured as a receiver the BRAVO module will remain in a low power listening mode. When a valid packet is received it will wake and action any output state changes required.

2. Watchdog enabled

If "watchdog" is enabled the BRAVO-Rx will await a signal from a paired BRAVO-Tx module. When the Watchdog signal is received OK then the watchdog output will be maintained active high.

If no watchdog signal is received in any 30minute period then the BRAVO-Rx will drop the Watchdog output.

NOTE: watchdog must be enabled on BOTH Tx and Rx for it to work.

Digital outputs

Active high LVCMOS / LVTTTL compatible outputs. Can be connected directly to CMOS/ TTL logic or drive.

Receiver example application circuit

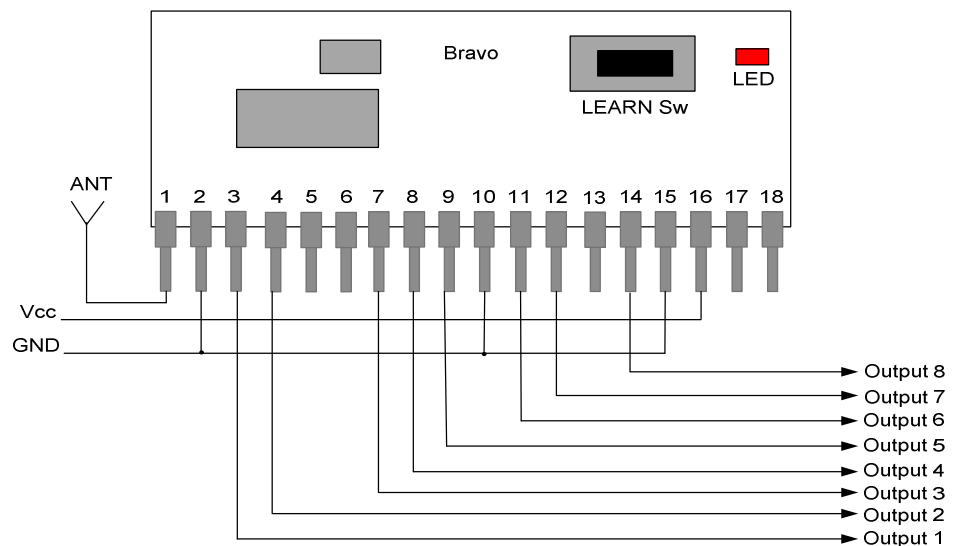

Description:

This example shows a BRAVO module configured as a receiver with all 8 outputs connected and watchdog disabled.

Note: The external learn switch and LED are also not fitted in this example.

Optional external learn switch and LED example circuit

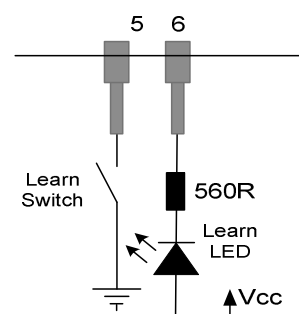

Pairing Process Bravo-Tx to Bravo-RX

Each BRAVO module has a unique serial number identity. They may be paired together using the LEARN button/input so that they operate in systems in: one:one, one:many and many:one formats. Each BRAVO-Rx can store 70 BRAVO-Tx identities.

Note: "watchdog" should not be enabled for many to one systems

3.1 Pairing process: Learn:

1. Briefly press the "LEARN" switch (or activate LEARN input) on the BRAVO-Rx
2. Briefly activate any input on the BRAVO-Tx

Pairing process: Erase

1. Press and Hold 'LEARN' switch (input) on the receiver for more than 10seconds.

3.2 LED indication of the pairing process is given by:

Mode	LED	Description
Normal operation	Flickering ON	Module is transmitting or receiving data
	OFF	No RF data is being transmitted/received
Learn mode (BRAVO-Rx only)	Flashing at low speed	BRAVO-RX Learn button pressed: module is searching for another to pair with. Learn mode times out after 10 seconds
	Flashing at high speed for 3secs	BRAVO-Rx pairing successful

Operational application examples

Application example one:one operation

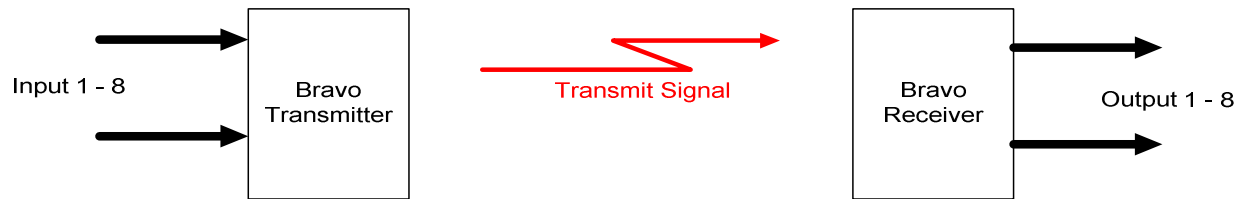

In this application the outputs at the receiver will match the inputs at the transmitter.

Application example: one:many operation

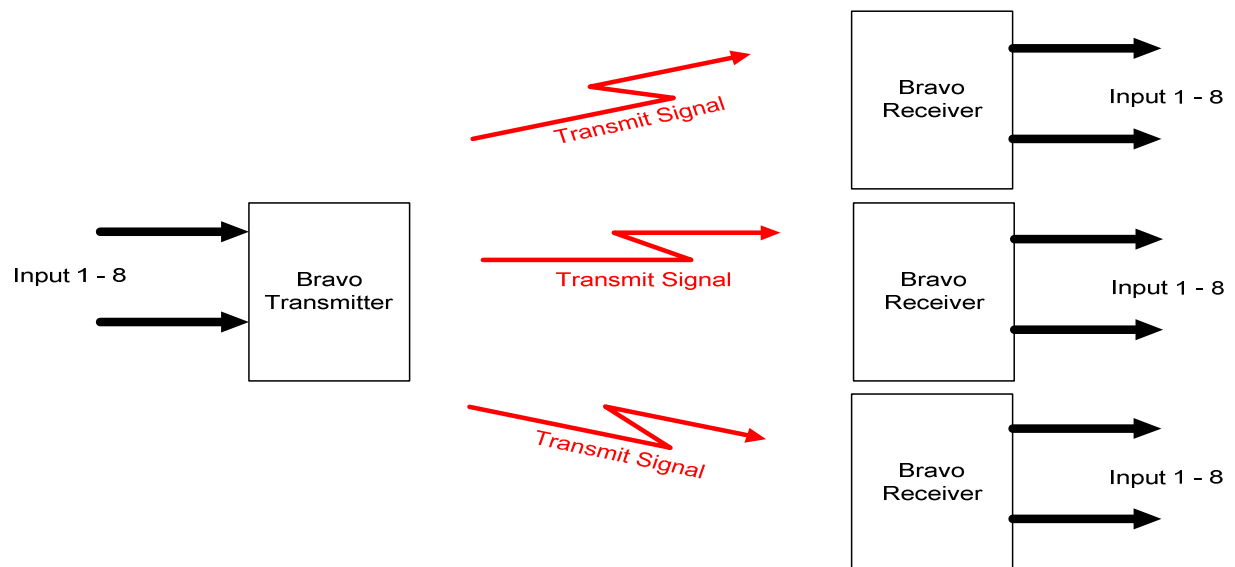

In this application the outputs at each of the receivers will track the inputs at the transmitter.

Mechanical Dimensions

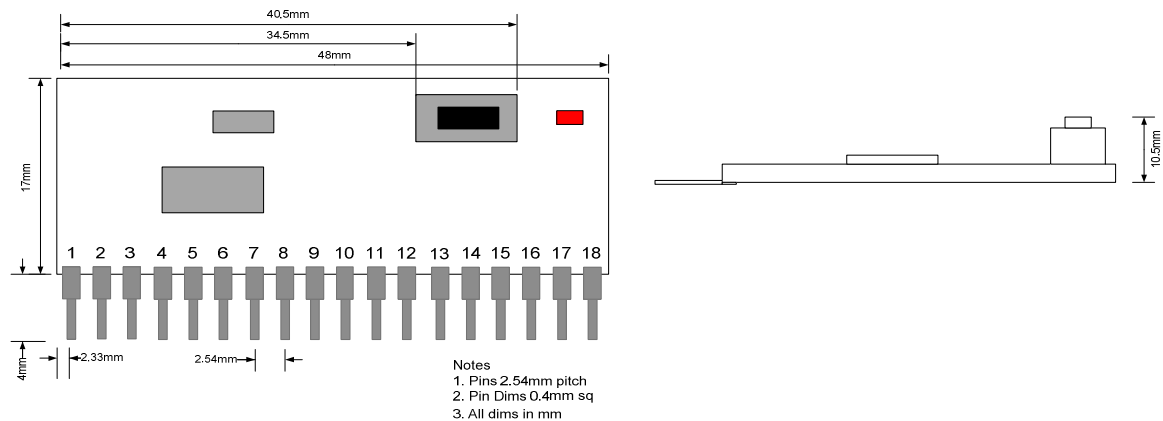

Range Considerations

The antenna choice and position directly affects the system range, keep it clear of any large metal parts. The best position is protruding vertically from the top of the product. This is often not desirable for practical reasons and thus a compromise may be needed. Note that the space around the antenna is as important as the antenna itself. All radio systems are dependent on a radio signal being received through airspace.

The range quoted is the optimal in direct line of sight without obstacles and in good atmospheric conditions.

Range is affected by many things, for example local environmental conditions, atmospheric conditions, interference from other radio transmitters. For evaluating the local environment please see our RF Meter (DS006)

In very worse case applications the range quoted may be reduced dramatically below the optimal range stated.

Self Test Mode

The Bravo Module incorporates a self test which is initiated by applying power with the learn Button being held down.

The Bravo Module then performs the following functions;

1. All I/O are set to outputs and are operated
2. in a traffic light sequence 0 to 8 to 0 again.
3. 4 on 4 off sequence
4. Transmits a full power RF signal for 10 seconds and operates the Learn LED
5. Enters RSSI (Received signal Strength) mode where outputs 1-8 are activated as a bar graph type output according to the strength of a valid RF signal received (from any carrier operating at the appropriate frequency (869.50MHz or 915MHz)
6. A Reset will be required to Exit

Technical Specifications

Absolute Maximums:

Temperature Range: Storage -50 to +125°C.

DC Characteristics

Parameter	Min	Max	Units
Supply Voltage	-0.3	4.0	V
Voltage on any Input	$V_{CC} > 2.2V$	5.8	V
	$V_{CC} < 2.2V$	$V_{CC}+3.6$	V
Max Input power (through RX antenna)		+5	dBm
Max Current Sourced / Sunk (Per I/O)		100	mA
Max Current Sourced / Sunk (Total)		200	mA

DC Characteristics

Parameter	Min	Typical	Max	Units
Supply Voltage	1.8		3.6	V
Operating Temperature	-40		+85	°C
BRAVO- Tx Supply Current:				
When Transmitting		30		mA
When sleeping		6		uA
BRAVO- Rx Supply Current:				
When Receiving		24		mA

AC Characteristics

Parameter	Min	Typical	Max	Units
Operating Frequency		869.5		MHz
Operating Freq for 915Mhz version	915.00		915.27	MHz
Operating Temperature	-40		+85	°C
BRAVO- Tx Output Power			+13	dBm
BRAVO- Tx—Rx FSK Raw RF Data Rate			9.6	Kbps
BRAVO- Rx Sensitivity		-121		dBm

BRAVO Telemetry Module

RF Meter

RF Multi Meter is a versatile handheld test meter checking Radio signal strength or interference in a given area. The Multi-Meter can both transmit and receive signals making it possible to test an installation location for suitability before installing equipment. The Multi-Meter is very hard wearing, long lasting and simple to use. It has 4 selectable frequencies, changeable at the touch of a button. It also has an auto shut off feature for battery saving.



Recommended Antenna 868MHz

We have a range of antennas on 868Mhz that are suitable for use with the Bravo modules.

To view our range please visit our website:

<http://www.rfsolutions.co.uk>



RF Solutions Ltd. Recycling Notice

Meets the following EC Directives:

DO NOT Discard with normal waste, please recycle.

ROHS Directive 2002/95/EC

Specifies certain limits for hazardous substances.

WEEE Directive 2002/96/EC

Waste electrical & electronic equipment. This product must be disposed of through a licensed WEEE collection point. RF Solutions Ltd., fulfils its WEEE obligations by membership of an approved compliance scheme.

RF Solutions Ltd.,
Unit 21, Cliffe Industrial Estate,
Lewes, E. Sussex. BN8 6JL. England.

Email : sales@rfsolutions.co.uk <http://www.rfsolutions.co.uk>

Tel Sales: 01273 898 020

Tel Technical: 01273 898 007

Tel Gen Enq: 01273 898 000

Fax: 01273 480 661

Whilst the information in this document is believed to be correct at the time of issue, RF Solutions Ltd does not accept any liability whatsoever for its accuracy, adequacy or completeness. No express or implied warranty or representation is given relating to the information contained in this document. RF Solutions Ltd reserves the right to make changes and improvements to the product(s) described herein without notice. Buyers and other users should determine for themselves the suitability of any such information or products for their own particular requirements or specification(s). RF Solutions Ltd shall not be liable for any loss or damage caused as a result of user's own determination of how to deploy or use RF Solutions Ltd's products. Use of RF Solutions Ltd products or components in life support and/or safety applications is not authorised except with express written approval. No licences are created, implicitly or otherwise, under any of RF Solutions Ltd's intellectual property rights. Liability for loss or damage resulting or caused by reliance on the information contained herein or from the use of the product (including liability resulting from negligence or where RF Solutions Ltd was aware of the possibility of such loss or damage arising) is excluded. This will not operate to limit or restrict RF Solutions Ltd's liability for death or personal injury resulting from its negligence.

www.rfsolutions.co.uk

RF Solutions Ltd

Unit 21 Cliffe Industrial Estate, Lewes, East Sussex, United Kingdom, BN8 6JL
Tel. Sales: +44 (0)1273 898 000 • Tech. Support: +44 (0)1273 898 007

