

European P.C.B. type terminal blocks / EK series

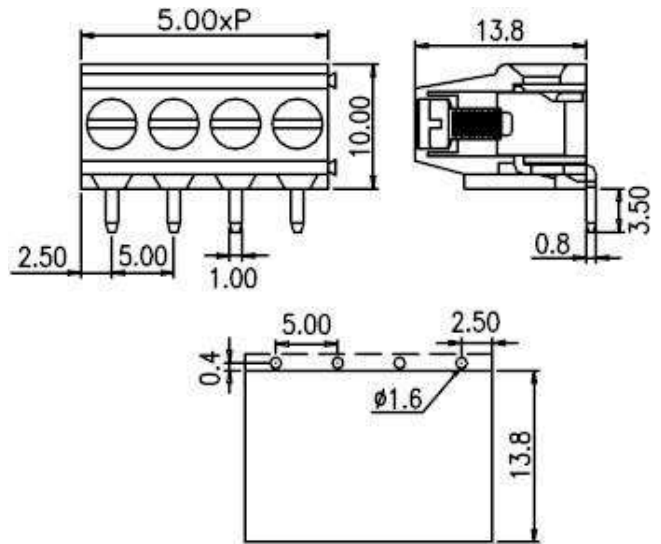

EK500R



Pitch: 5.00mm

Approval		
Technical Data	UL	IEC
Rated voltage	300V	250V
Rated current	20A	10A
Conductor cross-section, solid (AWG/ mm ²)	24~12 / 0.5~2.5	
Conductor cross-section, flexible (AWG/ mm ²)	24~12 / 0.5~2.5	
Rated surge voltage (UL/IEC/Max.)	1.6 / 2 / 3 KV	
Torque (N-m)	0.50	
Screw	M2.5	
Wire strip length	6~7mm	
Pole	Cat. No.	
02	EK500R-02P	
:	:	
:	:	
25	EK500R-25P	

TEL: +886-2-2908-0614

FAX: +886-2-2908-8549

E-mail: info@dinkle.com.tw