

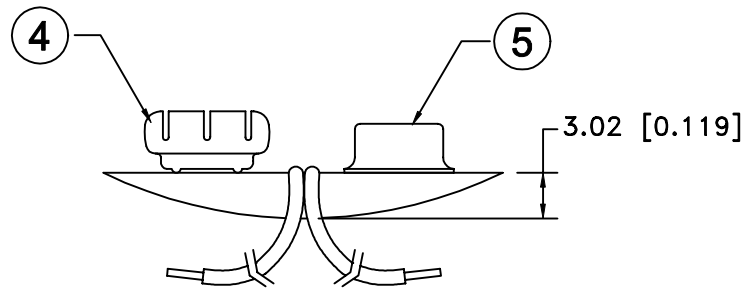

Date	SYM	REVISION RECORD	AUTH	DR.	CK.

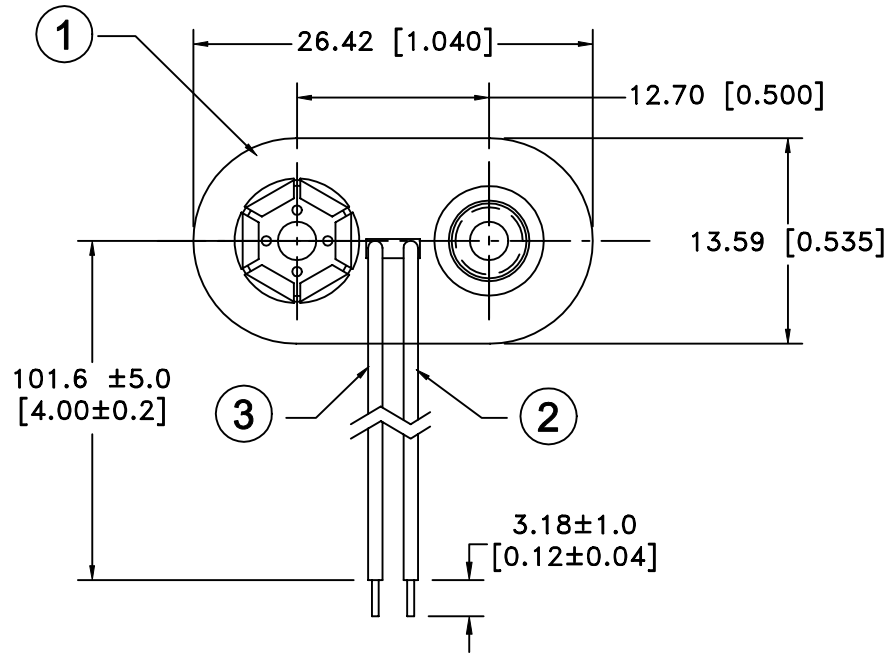

NO.	PART NAME	MATERIAL	QTY.	Tolerance	Memory Protection Devices, Inc		
1	COVER	PVC COVER OVER FIBERBOARD	1	(Except as noted)		200 Broad Hollow Road, Farmingdale, New York 11735	
2	BLACK WIRE(-)	24 AWG OR 26 AWG, UL-1007, CSA TR-64, 300V, 80°C	1	decimal		Scale	Drawn By B.S.
3	RED WIRE (+)	24 AWG OR 26 AWG, UL-1007, CSA TR-64, 300V, 80°C	1	±.5 (.020)		Approved By T.B.	
4	FEMALE SNAP	BRASS NICKLE PLATED	1	Fractional	Title		
5	MALE SNAP	BRASS NICKLE PLATED	1	± .8 (.030)	9 VOLT BATTERY SNAP-T STYLE-4" WIRE LEADS		
				Angular	Date	Drawing Number	
				± 3°	05/25/01	BS4T	