

Date	SYM	REVISION RECORD	AUTH	DR.	CK.

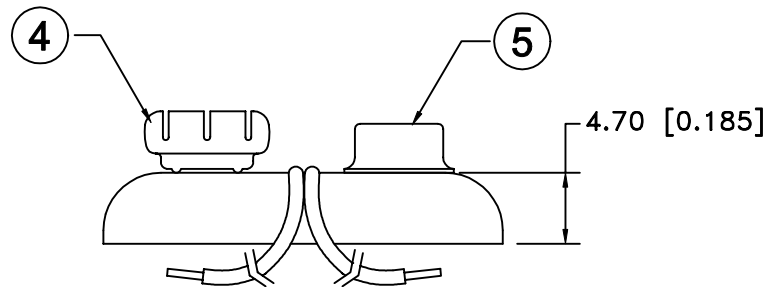
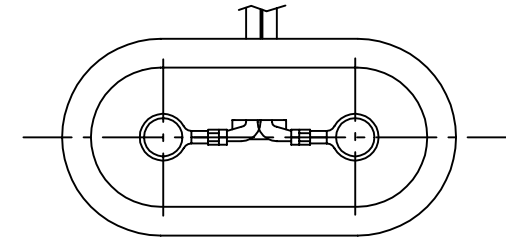
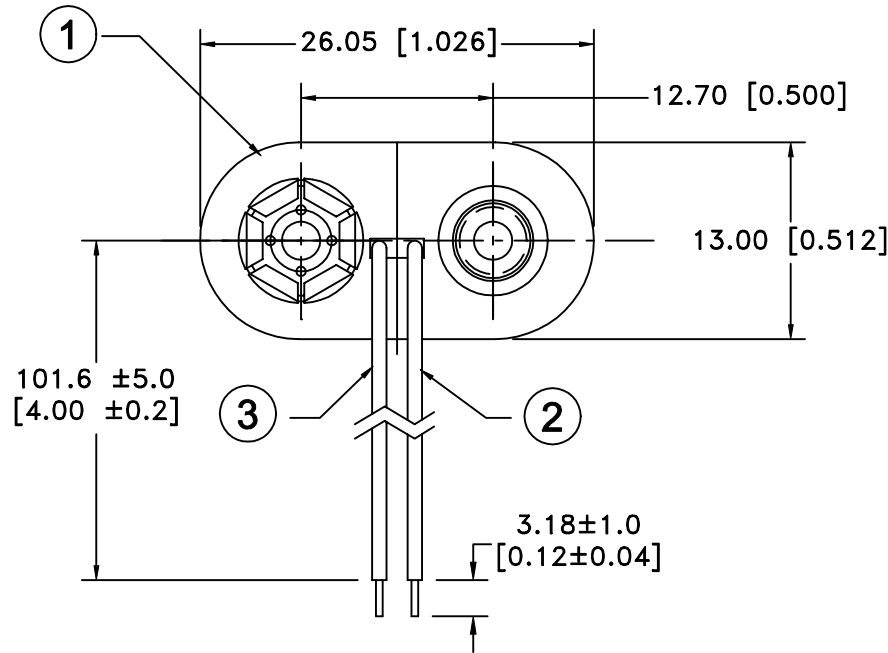

NOTES:

1. T STYLE 2 PCS. MOLDED CASE CONSTRUCTION WITH CRIMP CONNECTIONS. CRIMP ON WIRE INSULATION AND ON WIRE PROVIDES STRAIN RELIEF THAT STANDARD SOLDERED SNAPS DO NOT HAVE.

NO.	PART NAME	MATERIAL	QTY.	Tolerance	Memory Protection Devices, Inc	
1	MOLDED CASE	2 PCS., POLYETHYLENE, WHITE WITH BLUE INSERT	1	(Except as noted)	200 Broad Hollow Road, Farmingdale, New York 11735	
2	BLACK WIRE(-)	24 AWG OR 26 AWG, UL-1007, CSA TR-64, 300V, 80°C	1	decimal	Scale	Drawn By B.S.
3	RED WIRE (+)	24 AWG OR 26 AWG, UL-1007, CSA TR-64, 300V, 80°C	1	±.5 (.020)		Approved By T.B.
4	FEMALE SNAP	BRASS, NICKLE PLATED	1	Fractional	Title 9 VOLT BATTERY SNAP-T STYLE-4" WIRE LEADS, MOLDED CASE	
5	MALE SNAP	BRASS NICKLE PLATED	1	± .8 (.030)	Date	Drawing Number
				Angular	06/09/01	BS4T-MC
				± 3°		