

Date	SYM	REVISION RECORD	AUTH	DR.	CK.
2/25/06	A	ADDED "ROHS COMPLIANT"	T.B.	B.S.	

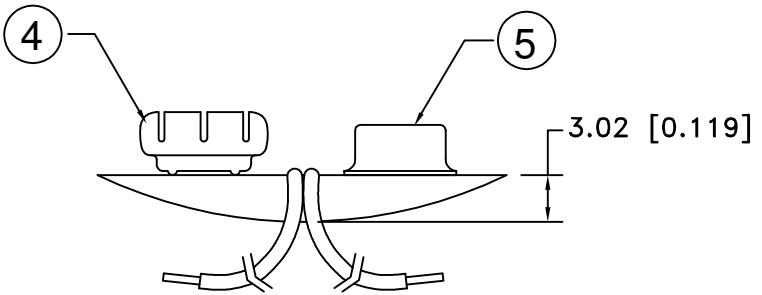
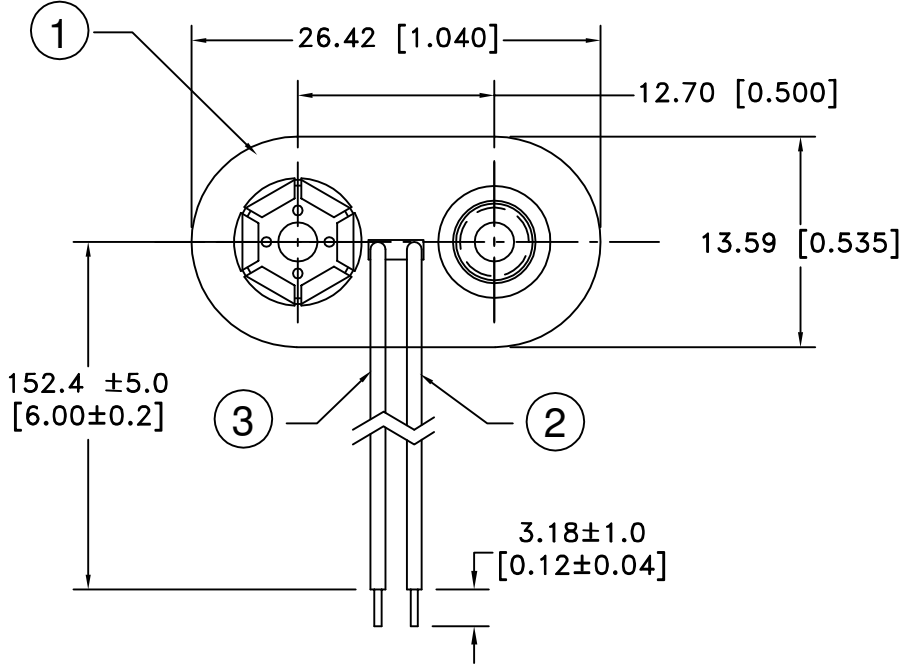

ROHS COMPLIANT

NO.	PART NAME	MATERIAL	QTY.	Tolerance (Except as noted)	Memory Protection Devices, Inc	
					200 Broad Hollow Road, Farmingdale, New York 11735	
1	COVER	PVC COVER OVER FIBERBOARD	1	decimal ±.5 (.020)	Scale	Drawn By B.S.
2	BLACK WIRE(-)	24 AWG OR 26 AWG, UL-1007, CSA TR-64, 300V, 80°C	1			Approved By T.B.
3	RED WIRE (+)	24 AWG OR 26 AWG, UL-1007, CSA TR-64, 300V, 80°C	1	Fractional ± .8 (.030)	Title 9 VOLT BATTERY SNAP-T STYLE-6" WIRE LEADS	
4	FEMALE SNAP	BRASS NICKLE PLATED	1			
5	MALE SNAP	BRASS NICKLE PLATED	1	Angular ± 3°	Date 2/25/06	Drawing Number BS6T