

**FEATURES**

- \* 0.3 inch (7.62 mm ) DIGIT HEIGHT
- \* EXCELLENT SEGMENT UNIFORMITY
- \* LOW POWER REQUIREMENT
- \* HIGH BRIGHTNESS AND HIGH CONTRAST
- \* WIDE VIEWING ANGLE
- \* SOLID STATE RELIABILITY
- \* BINNED FOR LUMINOUS INTENSITY

**DESCRIPTION**

The LSHD-7503 is a 0.3 inch (7.62 mm) digit height single-digit display. This device uses AS-AlInGaP RED LED chips (AlInGaP epi on GaAs substrate). The display has light gray face and white segments.

**DEVICE**

| <b>PART NO.</b> | <b>DESCRIPTION</b> |
|-----------------|--------------------|
| AlInGaP RED     | Common Cathode     |
| LSHD-7503       | Rt. Hande Decimal  |

**PACKAGE DIMENSIONS**

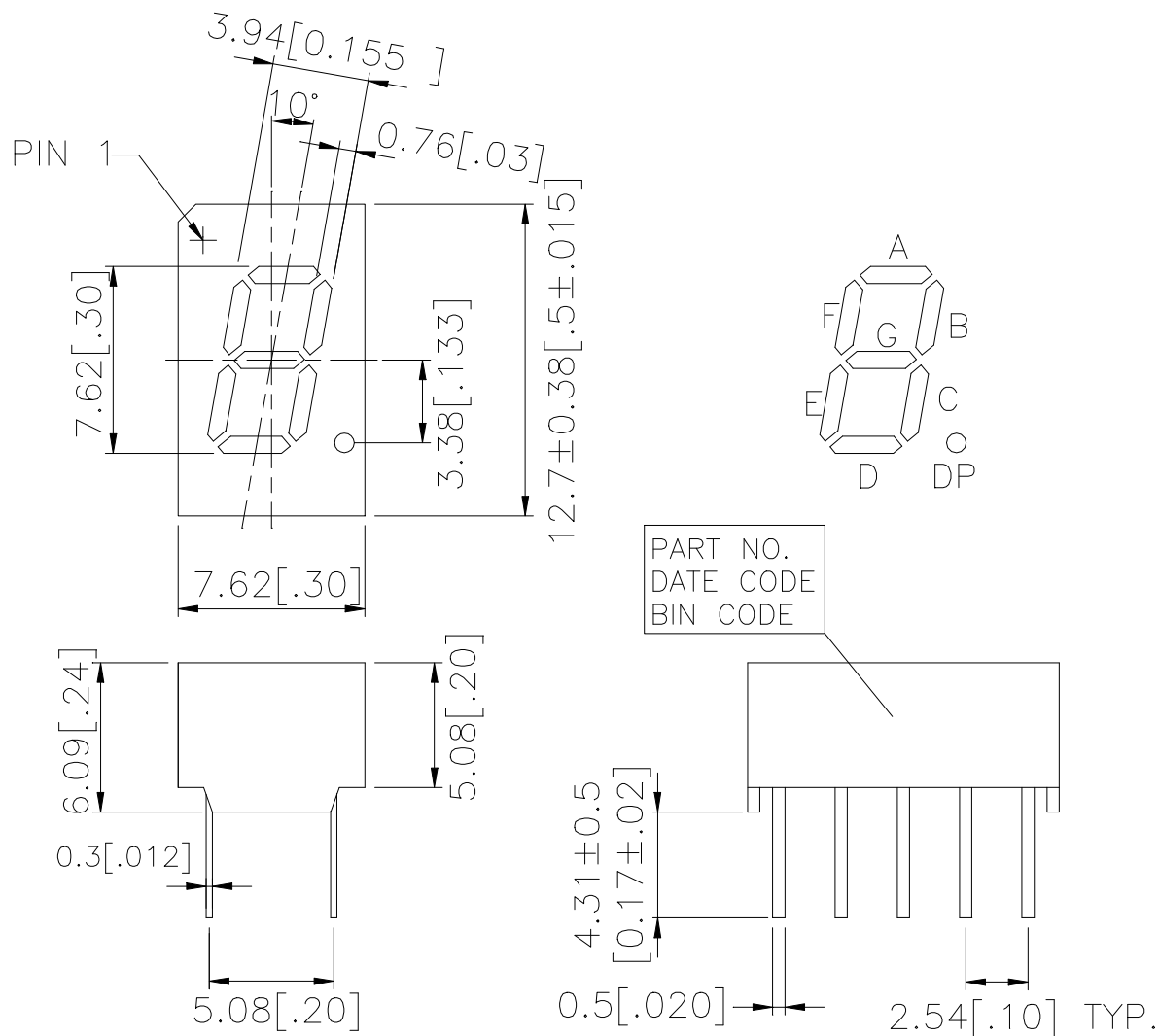

NOTES: All dimensions are in millimeters. Tolerances are ± 0.25mm (0.01“) unless otherwise noted.

**INTERNAL CIRCUIT DIAGRAM**

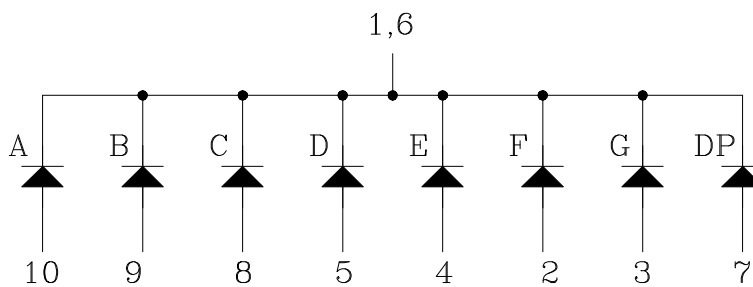

**PIN CONNECTION**

| <b>No.</b> | <b>CONNECTION</b> |
|------------|-------------------|
| 1          | Common Cathode    |
| 2          | Anode F           |
| 3          | Anode G           |
| 4          | Anode E           |
| 5          | Anode D           |
| 6          | Common Cathode    |
| 7          | Anode DP          |
| 8          | Anode C           |
| 9          | Anode B           |
| 10         | Anode A           |

**ABSOLUTE MAXIMUM RATING AT Ta = 25°C**

| PARAMETER   | MAXIMUM RATING  | UNIT  |
|---|-----------------|-------|
| Power Dissipation Per Segment   | 70              | mW    |
| Peak Forward Current Per Segment<br>( Frequency 1Khz, 15% duty cycle)       | 90              | mA    |
| Continuous Forward Current Per Segment                                      | 25              | mA    |
| Forward Current Derating from 25°C  | 0.28            | mA/°C |
| Reverse Voltage Per Segment   | 5               | V     |
| Operating Temperature Range   | -35°C to +105°C |       |
| Storage Temperature Range   | -35°C to +105°C |       |
| Soldering Conditions : 1/16 inch below seating plane for 3 seconds at 260°C |                 |       |

**ELECTRICAL / OPTICAL CHARACTERISTICS AT Ta = 25°C**

| PARAMETER                              | SYMBOL            | MIN         | TYP          | MAX   | UNIT | TEST CONDITION                                |
|--|-------------------|-------------|--------------|-------|------|---|
| Average Luminous Intensity Per Segment | I <sub>v</sub>    | 320<br>5400 | 923<br>12000 |       | μcd  | I <sub>F</sub> = 1mA<br>I <sub>F</sub> = 10mA |
| Peak Emission Wavelength               | λ <sub>p</sub>    |             | 632          |       | nm   | I <sub>F</sub> = 20mA                         |
| Spectral Line Half-Width               | Δλ                |             | 20           |       | nm   | I <sub>F</sub> = 20mA                         |
| Dominant Wavelength                    | λ <sub>d</sub>    |             | 624          |       | nm   | I <sub>F</sub> = 20mA                         |
| Forward Voltage Per Segment            | V <sub>F</sub>    |             | 2.1          | 2.6   | V    | I <sub>F</sub> = 20mA                         |
| Reverse Current Per Segment            | I <sub>R</sub>    |             |              | 100   | μA   | V <sub>R</sub> = 5V                           |
| Luminous Intensity Matching Ratio      | I <sub>v</sub> -m |             |              | 2 : 1 |      | I <sub>F</sub> = 1mA                          |

Note: Luminous Intensity is measured with a light sensor and filter combination that approximates the CIE (Commision Internationale De L'Eclairage) eye-response curve.

**TYPICAL ELECTRICAL / OPTICAL CHARACTERISTIC CURVES**

(25°C Ambient Temperature Unless Otherwise Noted)

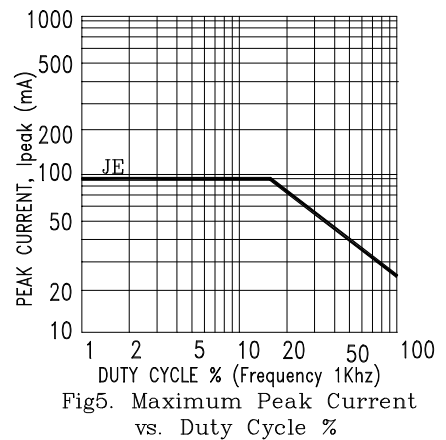
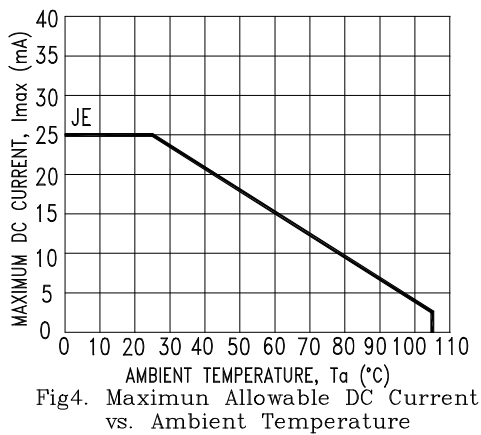
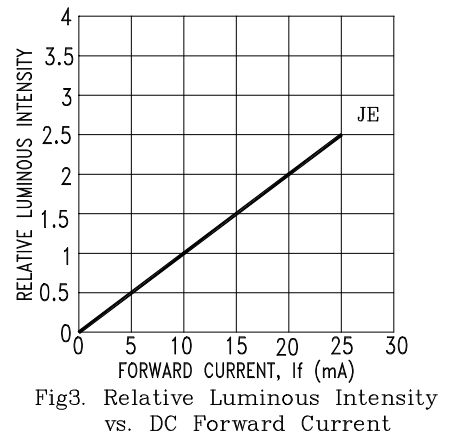
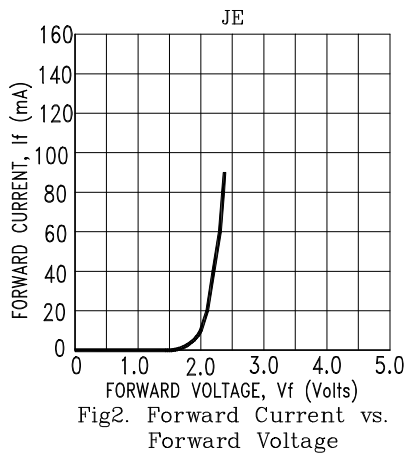
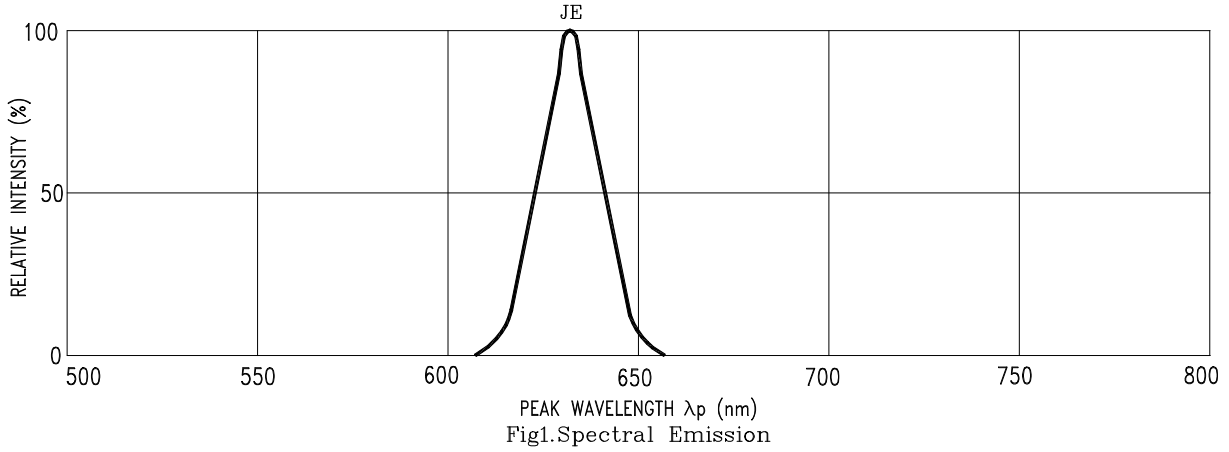

NOTE : JE=AlInGaP RED