

FEATURES

- * SELECTED TO SPECIFIC ON-LINE INTENSITY AND RADIANT INTENSITY RANGES
- * LOW COST MINIATURE PLASTIC END LOOKING PACKAGE
- * MECHANICALLY AND SPECTRALLY MATCHED TO THE LTR-3208 SERIES OF PHOTOTRANSISTOR
- * SMOKING TRANSPARENT COLOR PACKAGE

PACKAGE DIMENSIONS

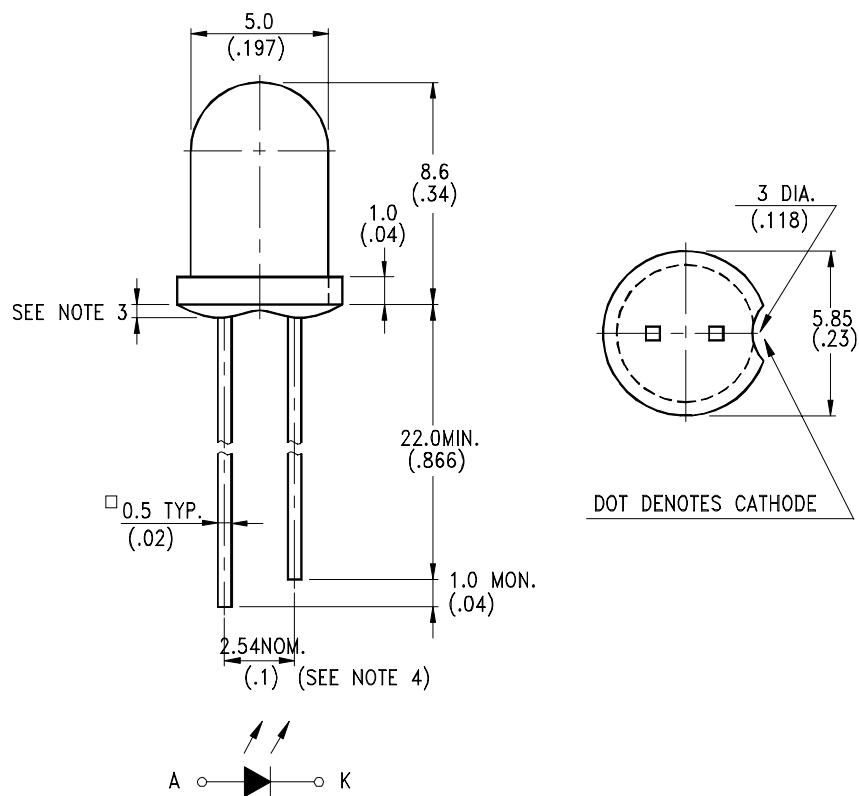

NOTES:

1. All dimensions are in millimeters (inches).
2. Tolerance is $\pm 0.25\text{mm}(.010\text{'})$ unless otherwise noted.
3. Protruded resin under flange is 1.5mm(.059") max.
4. Lead spacing is measured where the leads emerge from the package.
5. Specifications are subject to change without notice.



LITE-ON ELECTRONICS, INC.

Property of Lite-On Only

ABSOLUTE MAXIMUM RATINGS AT TA=25°C

| PARAMETER | MAXIMUM RATING | UNIT |
|--|---------------------|------|
| Power Dissipation | 150 | mW |
| Peak Forward Current (300pps, 10 μs pulse) | 2 | A |
| Continuous Forward Current | 100 | mA |
| Reverse Voltage | 5 | V |
| Operating Temperature Range | -40°C to +85°C | |
| Storage Temperature Range | -55°C to +100°C | |
| Lead Soldering Temperature [1.6mm(.063") From Body] | 260°C for 5 Seconds | |

ELECTRICAL OPTICAL CHARACTERISTICS AT TA=25°C

| PARAMETER | SYMBOL | MIN. | TYP. | MAX. | UNIT | TEST CONDITION | BIN NO. |
|----------------------------|-------------------|------|------|-------|--------------------|-----------------------|---------|
| Aperture Radiant Incidence | E _e | 0.44 | | 0.96 | mW/cm ² | I _F = 20mA | BIN A |
| | | 0.64 | | 1.20 | | | BIN B |
| | | 0.80 | | 1.68 | | | BIN C |
| | | 1.12 | | | | | BIN D |
| Radiant Intensity | I _E | 3.31 | | 7.22 | mW/sr | I _F = 20mA | BIN A |
| | | 4.81 | | 9.02 | | | BIN B |
| | | 6.02 | | 12.63 | | | BIN C |
| | | 8.42 | | | | | BIN D |
| Peak Emission Wavelength | λ _{Peak} | | 940 | | nm | I _F = 20mA | |
| Spectral Line Half-Width | Δλ | | 50 | | nm | I _F = 20mA | |
| Forward Voltage | V _F | | 1.2 | 1.6 | V | I _F = 20mA | |
| Reverse Current | I _R | | | 100 | μA | V _R = 5V | |
| Viewing Angle (See FIG.6) | 2θ _{1/2} | | 40 | | deg. | | |

TYPICAL ELECTRICAL / OPTICAL CHARACTERISTICS CURVES

(25°C Ambient Temperature Unless Otherwise Noted)

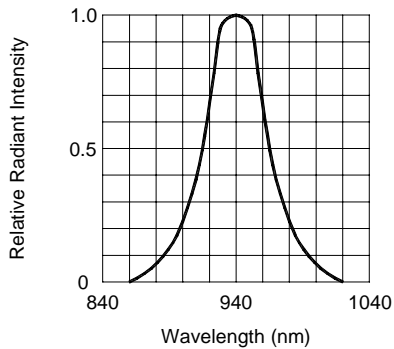

FIG.1 SPECTRAL DISTRIBUTION

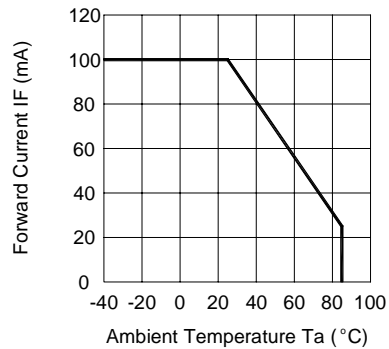

FIG.2 FORWARD CURRENT VS. AMBIENT TEMPERATURE

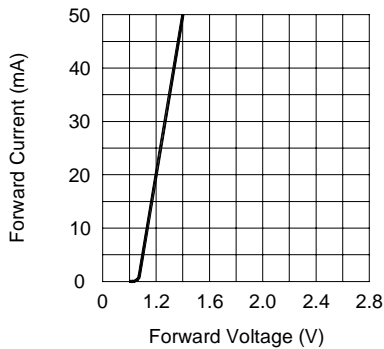

FIG.3 FORWARD CURRENT VS. FORWARD VOLTAGE

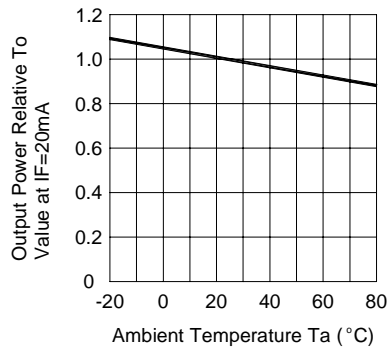

FIG.4 RELATIVE RADIANT INTENSITY VS. AMBIENT TEMPERATURE

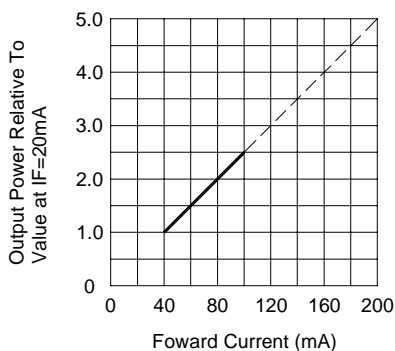

FIG.5 RELATIVE RADIANT INTENSITY VS. FORWARD CURRENT

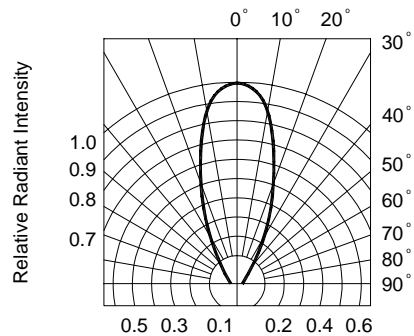

FIG.6 RADIATION DIAGRAM