



January 2010

FEATURES

- * Isolation voltage between input and output $V_{iso} : 5,000V_{rms}$
- * 6pin DIP photocoupler, triac driver output
- * High repetitive peak off-state voltage $V_{DRM} : \text{Min. } 400V$
- * High critical rate of rise of off-state voltage
($dV/dt : \text{MIN. } 100V / \mu s$)
- * Dual-in-line package :
MOC3020, MOC3021, MOC3022, MOC3023
- * Wide lead spacing package :
MOC3020M, MOC3021M, MOC3022M, MOC3023M
- * Surface mounting package :
MOC3020S, MOC3021S, MOC3022S, MOC3023S
- * Tape and reel packaging :
MOC3020S-TA1, MOC3021S-TA1, MOC3022S-TA1, MOC3023S-TA1
- * Safety approval
UL / CSA / FIMKO / VDE* approved
*Required "V" ordering option

APPLICATIONS

- * Motor Controls
- * Solid state relays
- * For triggering high power thyristor and triac
- * Household use equipment

OUTLINE DIMENSIONS

Dual-in-line package :

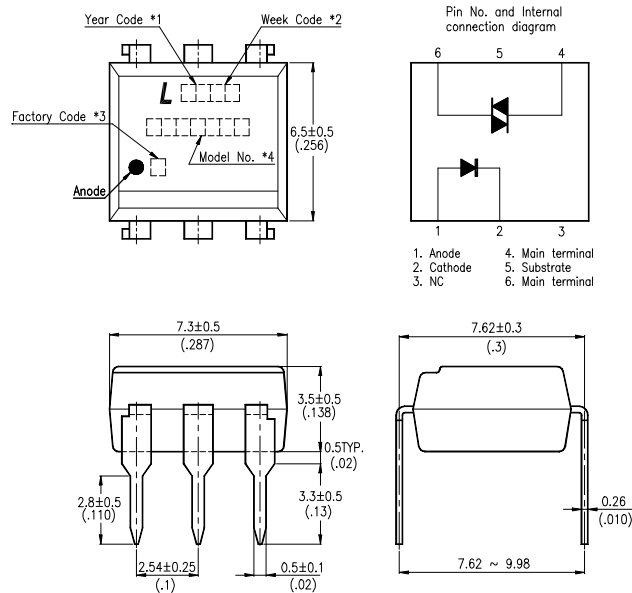

Wide lead spacing package:

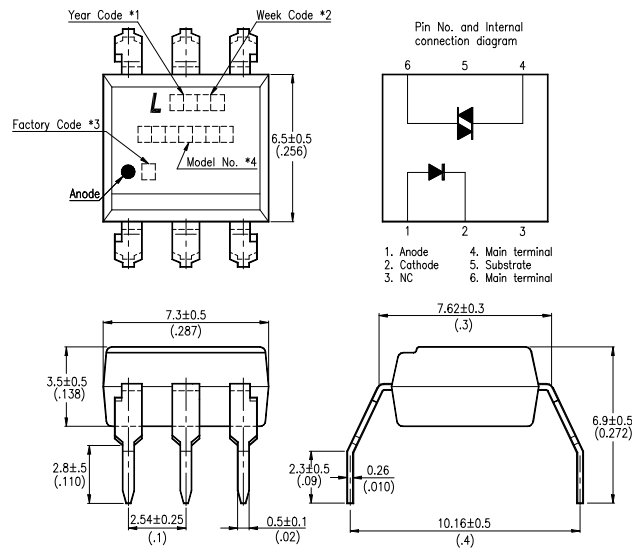

- *1. Year date code.
- *2. 2-digit work week.
- *3. Factory identification mark shall be marked.
(Z : Taiwan, Y : Thailand, X : China-TJ, W : China-CZ)
- *4. Model No.: MOC3020 ; MOC3021 ; MOC3022 ; MOC3023

OUTLINE DIMENSIONS

Surface mounting package :

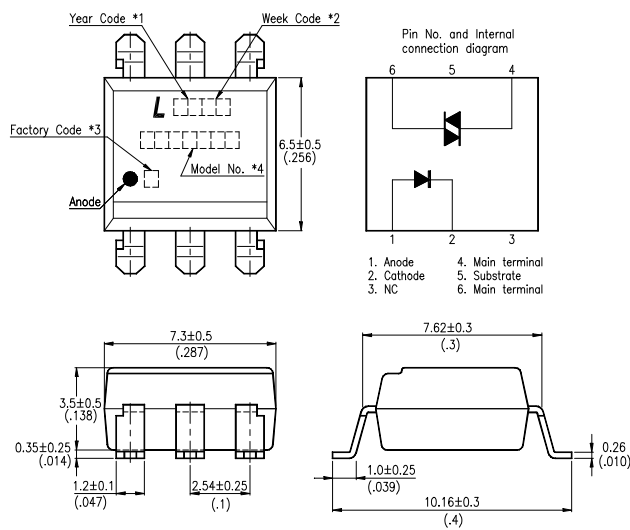

- *1. Year date code.
- *2. 2-digit work week.
- *3. Factory identification mark shall be marked.
(Z : Taiwan, Y : Thailand, X : China-TJ, W : China-CZ)
- *4. Model No.: MOC3020 ; MOC3021 ; MOC3022 ; MOC3023

TAPING DIMENSIONS

Tape and reel package (TYPE II):

MOC3020S-TA1, MOC3021S-TA1, MOC3022S-TA1, MOC3023S-TA1

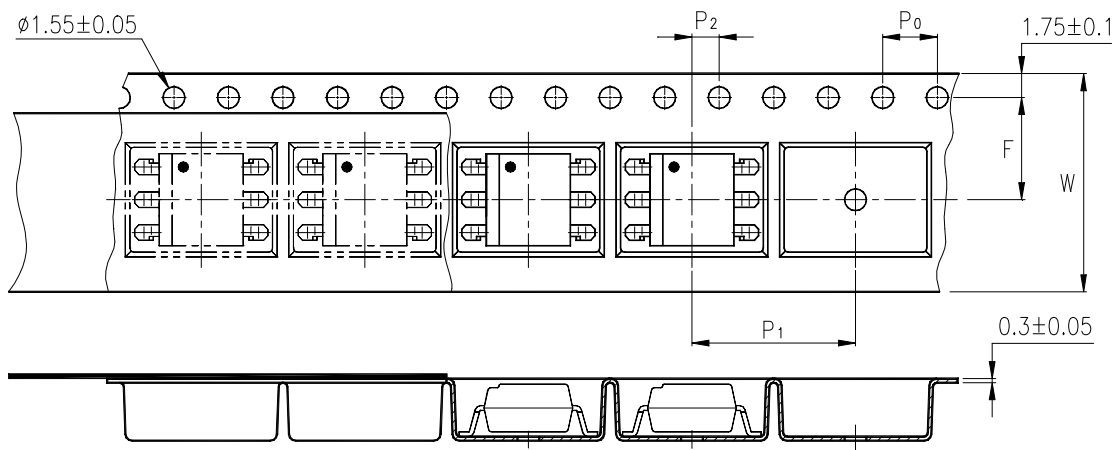

Description	Symbol	Dimensions in mm (inches)
Tape wide	W	16 ± 0.3 (.63)
Pitch of sprocket holes	P_0	4 ± 0.1 (.15)
Distance of compartment	F	7.5 ± 0.1 (.295)
Distance of compartment to compartment	P_2	2 ± 0.1 (.079)
Distance of compartment to compartment	P_1	12 ± 0.1 (.472)

ABSOLUTE MAXIMUM RATING

(Ta = 25°C)

PARAMETER		SYMBOL	RATING	UNIT
INPUT	Forward Current	I _F	50	mA
	Reverse Voltage	V _R	6	V
	Power Dissipation	P _D	70	mW
OUTPUT	Off-State Output Terminal Voltage	V _{DRM}	400	V
	Peak Repetitive Surge Current (PW=1ms, 120pps)	V _{TSM}	1	A
	Collector Power Dissipation	P _C	300	mW
Total Power Dissipation		P _{tot}	330	mW
*1	Isolation Voltage	V _{iso}	5,000	V _{rms}
Ambient Operating Temperature Range		T _A	-40 ~ +100	°C
Storage Temperature Range		T _{stg}	-55 ~ +150	°C
*2	Soldering Temperature	T _L	260	°C

*1. AC For 1 Minute, R.H. = 40 ~ 60%

Isolation voltage shall be measured using the following method.

- (1) Short between anode and cathode on the primary side and between collector, emitter on the secondary side.
- (2) The isolation voltage tester with zero-cross circuit shall be used.
- (3) The waveform of applied voltage shall be a sine wave.

*2. For 10 Seconds

ELECTRICAL - OPTICAL CHARACTERISTICS

(Ta = 25°C)

PARAMETER		SYMBOL	MIN.	TYP.	MAX.	UNIT	CONDITIONS	
INPUT	Forward Voltage	V_F	—	1.15	1.5	V	$I_F=20\text{mA}$	
	Reverse Current	I_R	—	—	10	μA	$V_R=6\text{V}$	
OUTPUT	*1 Peak Blocking Current, Either Direction	I_{DRM}	—	10	100	nA	$V_{\text{DRM}} = 400\text{V}$	
	Peak On-State Voltage, Either Direction	V_{TM}	—	1.7	3	V	$I_{\text{TM}}=100\text{ mA Peak}$	
	*2 Critical rate of Rise of Off-State Voltage	dv/dt	100	—	—	V/ μs		
COUPLED	*3 Led Trigger Current, Current Required to Latch Output, Either Direction	MOC3020	I_{FT}	—	15	30	mA	Main Terminal Voltage = 3V
		MOC3021		—	8	15		
		MOC3022		—	—	10		
		MOC3023		—	—	5		
	Holding Current, Either Direction	I_H	250	—	—	μA		

*1 Test voltage must be applied within dv/dt rating.

*2 This is static dv/dt. Commutating dv/dt is a function of the load-driving thyristor(s) only.

*3 All devices are guaranteed to trigger at an I_F value less than or equal to max I_{FT} . Therefore, recommended operating I_F lies between max I_{FT} , 30 mA for MOC3020, 15 mA for MOC3021, 10 mA for MOC3022, 5 mA for MOC3023, and absolute max I_F (50mA)

CHARACTERISTICS CURVES

Fig.1 Forward Current vs. Ambient Temperature

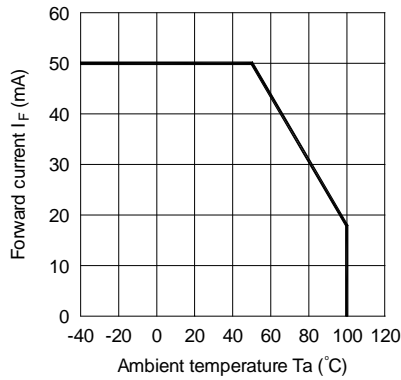

Fig.2 On-state Current vs. Ambient Temperature

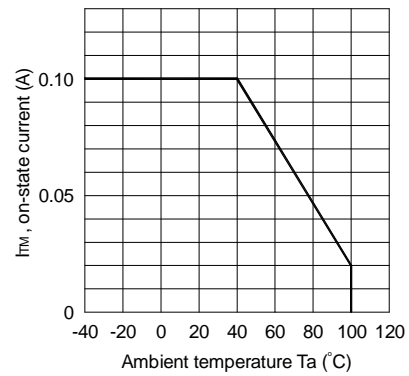

Fig.3 Minimum Trigger Current vs. Ambient Temperature

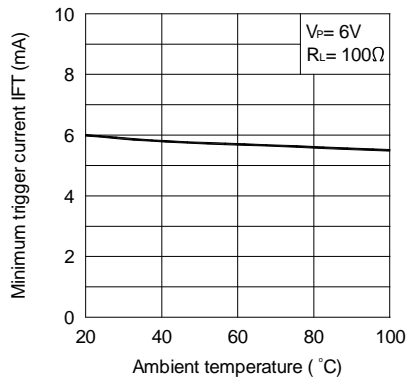

Fig.4 Forward Current vs. Forward Voltage

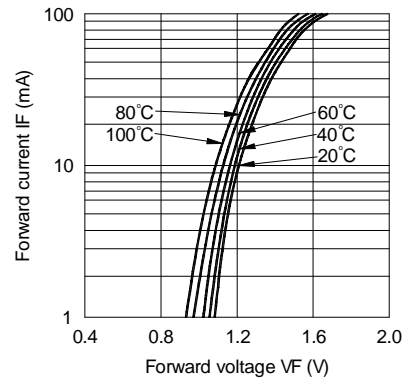

Fig.5 On-state Voltage vs. Ambient Temperature

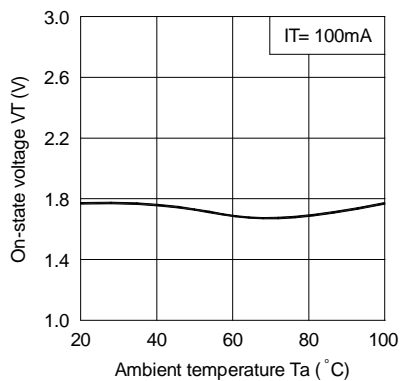
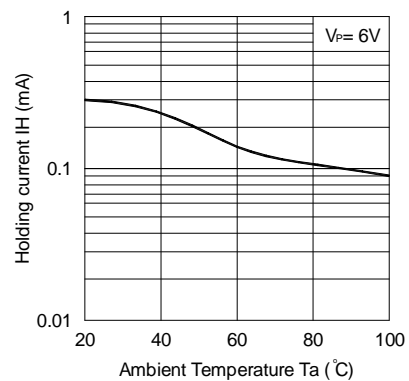

Fig.6 Holding Current vs. Ambient Temperature



CHARACTERISTICS CURVES

Fig. 7 Repetitive Peak Off-state Current vs. Temperature

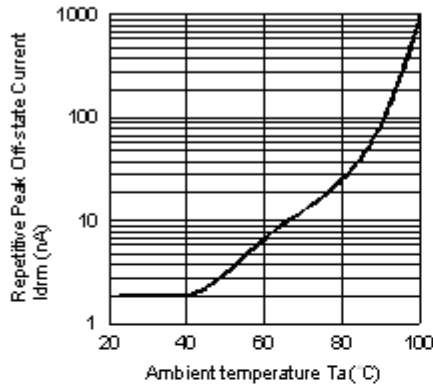
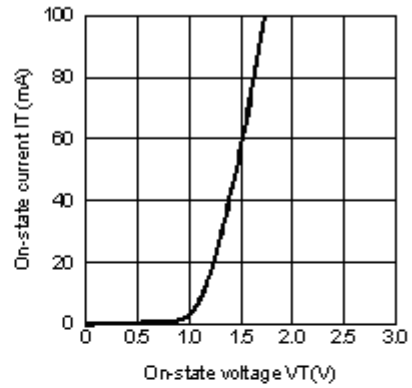
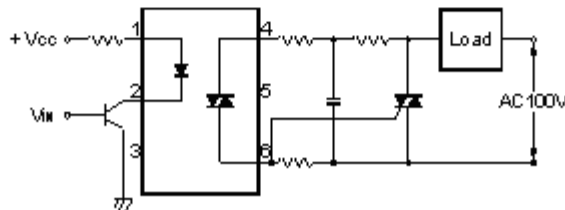

Fig. 8 On-state Current vs. On-state Voltage



Basic Operation Circuit
Medium/High Power Triac Drive Circuit



RECOMMENDED FOOT PRINT PATTERNS (MOUNT PAD)

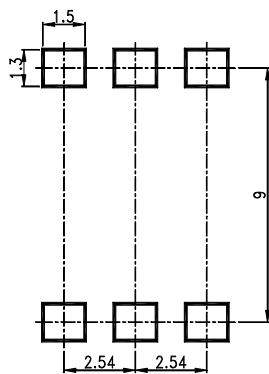

Unit : mm

Notes:

- Lite-On is continually improving the quality, reliability, function or design and Lite-On reserves the right to make changes without further notices.
- The products shown in this publication are designed for the general use in electronic applications such as office automation equipment, communications devices, audio/visual equipment, electrical application and instrumentation.
- For equipment/devices where high reliability or safety is required, such as space applications, nuclear power control equipment, medical equipment, etc, please contact our sales representatives.
- When requiring a device for any "specific" application, please contact our sales in advice.
- If there are any questions about the contents of this publication, please contact us at your convenience.
- The contents described herein are subject to change without prior notice.