

DC-DC Converter Application Manual

MPD6D11*S

1. Features

- 1.1 Ultra Low Profile(39.9 x 31.2 x 4.0mm Typ.) SMD.
- 1.2 High efficiency & High power density achieved via Murata proprietary synchronous rectifier circuit.
- 1.3 Wide operating temperature range. -40 to +85 °C.
- 1.4 Wide input voltage range. 36 to 75V
- 1.5 Up to 10 devices in Parallel Operation.
- 1.6 Input-to-output isolation: 1.5kV(DC) for one minute.
- 1.7 Built in Over-Current Protection , Over Voltage Protection & Over-Heating Protection.
- 1.8 UL60950 Recognized.

2. Product Line Up

2.1 TN15W Series

Nominal Output Voltage [V]	Part No.
1.2	MPD6D112S
1.5	MPD6D113S
1.8	MPD6D114S
2.5	MPD6D116S
3.3	MPD6D117S
5.0	MPD6D118S
5.2	MPD6D119S
12.0	MPD6D111S

3. Ratings

- 3.1 Operating Temperature Range -40C. to +85 °C.
- 3.2 Operating Humidity Range 20% to 85%RH (No condensation)
- 3.3 Storage Temperature Range -45C. to +90 °C.
- 3.4 Storage Humidity Range 10% to 95%RH (No condensation)

4. Electrical Characteristics

4-1. Absolute Maximum Ratings

Items			Unit	Maximum	Remark
Minimum Input Voltage			V	0	
Maximum Input Voltage	Time	Continuous	V	75	
RC Pin Voltage		200us	V	90	Slew rate : 42V/10us
ALM Pin Voltage			V	8	
PO Pin Voltage			V	8	
ALM Pin Maximum Sink Current			mA	10	

⚠ Note:

1. This datasheet is downloaded from the website of Murata Manufacturing co., ltd. Therefore, it's specifications are subject to change or our products in it may be discontinued without advance notice. Please check with our sales representatives or product engineers before ordering.
2. This datasheet has only typical specifications because there is no space for detailed specifications. Therefore, please approve our product specifications or transact the approval sheet for product specifications before ordering.

4-2.General Characteristics (Statics , Ambient temperature : Ta=-40 to +85 °C)

Items	Unit	Value	Remark
Rated Input Voltage	V	48	
Input Voltage Range	V	36 to 60	No power derating with 0.2m/s(40LFM)
		36 to 75	No power derating with 0.5m/s(100LFM).
		36 to 75	Power derating with 0m/s(0LFM)
Turn-on Input Voltage	V	32.0 to 36.0	
Hysterisis Voltage	V	Minimum 2	Input voltage difference between turn-on/off
Galvanic Isolation Voltage	Vdc	Minimum 1500	For one minute between input and output
EMC (Radiated EMI / Conduction)		In accordance with CISPR Publication22,Class A (VCCI Class A)	
Safety Standards		UL60950(UL / C-UL)	Recognized
CE Marking		Attached	Self-declaration

⚠ **Note:**

1. This datasheet is downloaded from the website of Murata Manufacturing co., ltd. Therefore, it's specifications are subject to change or our products in it may be discontinued without advance notice. Please check with our sales representatives or product engineers before ordering.
2. This datasheet has only typical specifications because there is no space for detailed specifications. Therefore, please approve our product specifications or transact the approval sheet for product specifications before ordering.

4-3. Output Characteristics Ta = -40 to 85°C

Items		MPD6D***S								Unit
		111	112	113	114	116	117	118	119	
Nominal Output Voltage		12.0	1.2	1.5	1.8	2.5	3.3	5.0	5.2	V
Output Voltage Regulation Vin =36 to 75V Output current range = 0 to 100%		+5,-3								%
Nominal Output Current		1.2	5.2	5.2	4.5	4.5	4.5	3.0	3.0	A
Output Current-limit Inception	Min	1.23	5.35	5.35	4.63	4.63	4.63	3.09	3.09	A
Over Voltage Protection: Note 2	Min	14.4	1.44	1.80	2.16	3.00	3.96	6.00	6.24	V
Low Voltage Protection: Note 3	Max	10.8	1.08	1.35	1.62	2.25	2.97	4.50	4.68	V
Efficiency(typ.) Ta=25°C, Vin=48V, Nominal output current		86	82	84	87	88	90	90	90	%
Output Ripple and Noise Note 4	Max	100	50	50	50	50	50	50	50	mVp-p
Output Ripple Note 4	Max	50	25	25	25	25	25	25	25	mVp-p

Note 1: Nominal Output Current of MPD6D111S is power-derated. Refer to Typical power derating.

Note 2: Output is halted in latch-up mode after a mask time 0.5ms (typ.), preventing

DC-DC Converter from malfunction by external noise and/or transient output voltage change.

Note 3: Output is halted in latch-up mode after mask time of 500ms(typ.),

preventing DC-DC Converter from malfunction by external noise and/or
transient output current change.

Note 4: Refer to section 10. Measurement Setup.

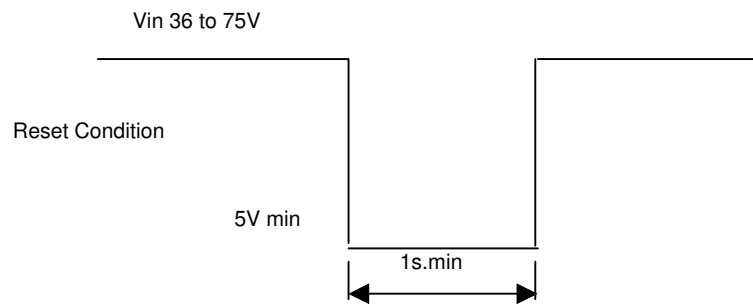
⚠ **Note:**

1. This datasheet is downloaded from the website of Murata Manufacturing co., ltd. Therefore, it's specifications are subject to change or our products in it may be discontinued without advance notice. Please check with our sales representatives or product engineers before ordering.
2. This datasheet has only typical specifications because there is no space for detailed specifications. Therefore, please approve our product specifications or transact the approval sheet for product specifications before ordering.

5. Operation Information

5-1. Reset Condition

In order to reset all functions, the input voltage (V_{in}) must be set under 5V for 1s. min.



5-2. Over Voltage Protection (OVP)

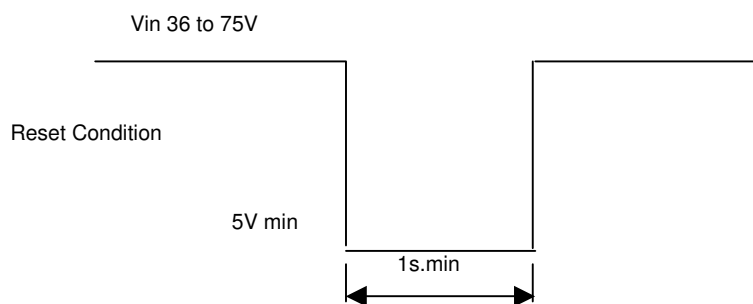
The Isolated DC-DC Converter enters latch-up mode after a typical 0.5ms. mask time, when the output voltage is over the value specified in Over Voltage Protection (section 4.3) by failure of internal control circuit.

In order to reset, the input voltage must be set under 5V for 1s. min.

Output voltage might exceed the point at which OVP starts to function under conditions of transient input voltage or output current changes.

Therefore, OVP is set to wait for the mask time 0.5ms.

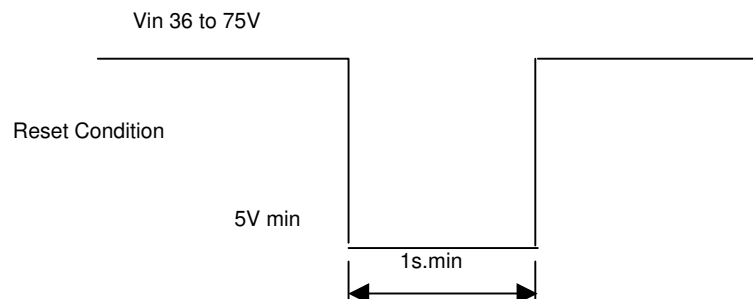
It is recommended to evaluate your equipment installed with the DC-DC Converter.



5-3. Low Voltage Protection (LVP)

The Isolated DC-DC Converter enters latch-up mode after typical 500ms. mask time, when the output voltage is under the value specified in Low Voltage Protection (section 4.3) by operating Over Current-limit Inception due to failure of internal control or over load.

In order to reset, the input voltage must be set under 5V for 1s. min.



⚠ Note:

1. This datasheet is downloaded from the website of Murata Manufacturing co., ltd. Therefore, it's specifications are subject to change or our products in it may be discontinued without advance notice. Please check with our sales representatives or product engineers before ordering.
2. This datasheet has only typical specifications because there is no space for detailed specifications. Therefore, please approve our product specifications or transact the approval sheet for product specifications before ordering.

5-4. Remote On/Off Control

The connection to a RC pin controls an Isolated DC-DC Converter to turn on/off. While the Isolated DC-DC Converter is halted via the remote control feature, the alarm function will not operate; refer to Alarm Output (section 5-5).

Start : RC open or connected to -Vin
Halt : RC connected to +Vin

5-5. Alarm Output (ALM)

The Alarm Output can be down to the level of -Vin (Open Drain Output), when Over Voltage Protection or Low Voltage Protection features are activated. The sink current in ALM pin is 10mA max. Multiple Isolated DC-DC Converters running independently and / or in parallel operation can be simultaneously halted by connecting all ALM pins, when the Over Voltage Protection or Low Voltage Protection functions are activated by any single DC-DC Converter. The maximum number connected running DC-DC Converters is 10pcs.

To connect more than 10 please consult with Murata.

5-6. Synchronous Turn-on/off

Multiple Isolated DC-DC Converters running independently and / or in parallel operation can be synchronously toggled on & off timing among the running converters, of which the input voltage detection circuits are tied to the detection voltage of a single reference Isolated DC-DC Converter. Every PO pin must be connected for multiple and/or parallel operation. The Maximum number connected running DC-DC Converters is 10pcs.

To connect more than 10 please consult Murata.

6. Parallel Operation

6-1 Parallel Operation Description (Current sharing)

When the output current required is more than that available from one DC-DC Converter an alternative to choosing a higher power rated DC-DC Converters is to operate multiple DC-DC Converters in parallel.

It is possible to run up to 10 DC-DC Converters in parallel operation.

Combining different Murata model devices with identical output voltages (designed for telecomm/datacomm equipment) is possible. To optimize this feature all PO pins should be connected so that the turn-on / off of all connected DC-DC Converters are synchronized. Additionally connecting the ALM pins of the devices in parallel operation enables simultaneous shut down of all DC-DC Converters when one is halted and generates an ALM signal due to an OVP or LVP condition.

6-2 Load Balance in Parallel Operation

No external load balancing circuit or reverse-current prevention circuit is necessary for Murata's DC-DC converters operating in parallel. Murata's DC-DC converters are designed to regulate load balancing and prevent reverse-current.

The combined devices operated in parallel provide an output voltage within the tolerance specified for either device (e.g. +5% / -3%). This tolerance is maintained throughout the output current variance from zero to the rated current value. This feature automatically balances the output currents from all of the parallel DC-DC converters.

⚠ Note:

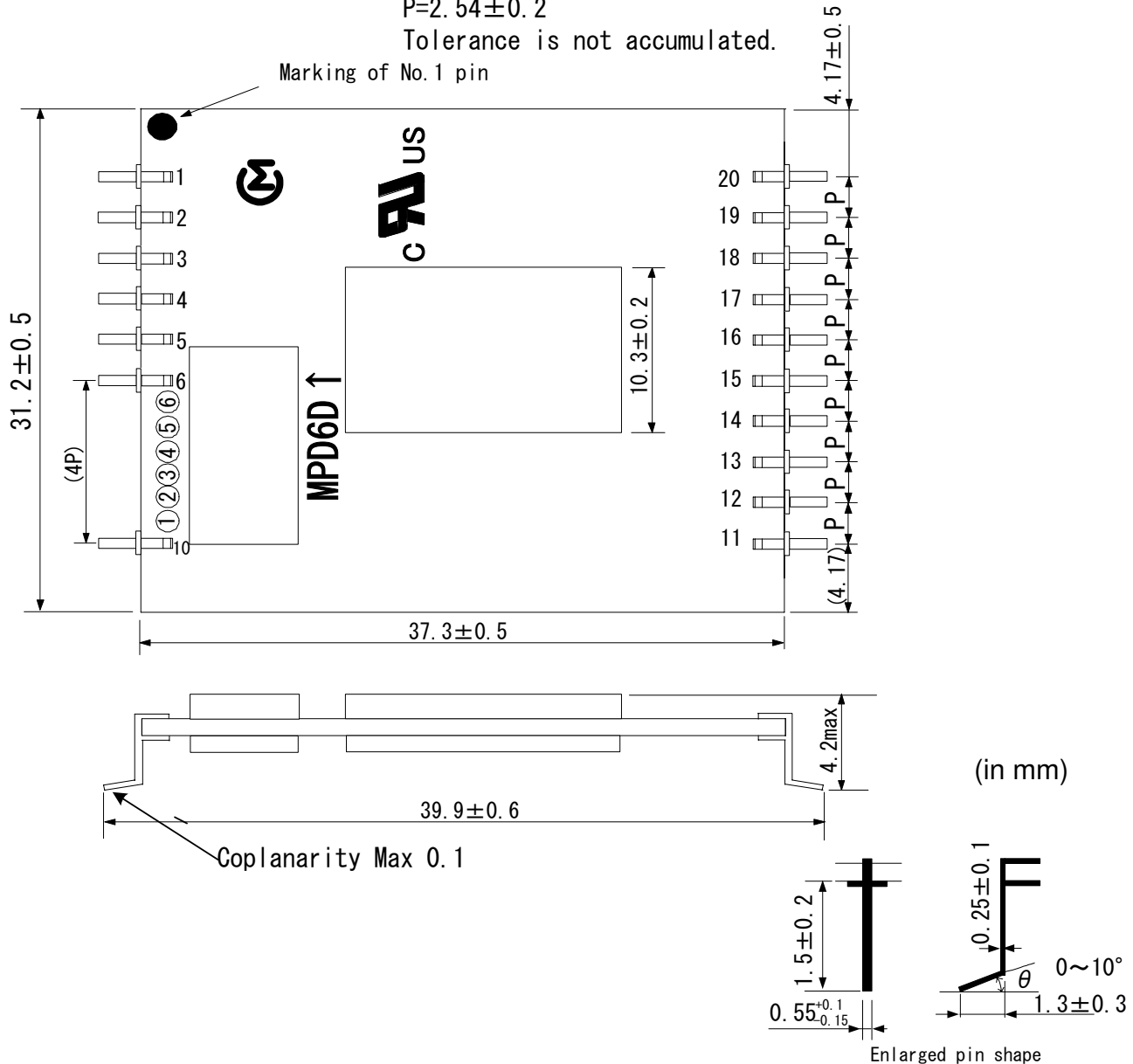
1. This datasheet is downloaded from the website of Murata Manufacturing co., ltd. Therefore, it's specifications are subject to change or our products in it may be discontinued without advance notice. Please check with our sales representatives or product engineers before ordering.
2. This datasheet has only typical specifications because there is no space for detailed specifications. Therefore, please approve our product specifications or transact the approval sheet for product specifications before ordering.

7. Appearance, Dimensions

$$P=2.54\pm 0.2$$

Tolerance is not accumulated.

Marking of No. 1 pin



Marking

Part Number MPD6D11_
(Omitted S of MPD6D11_S)

Murata CM Mark
Lot Number



- 1) Factory symbol
- 2) The last number of production year. Example: 2 stands for 2002
- 3) Production month. Example: 1 stands for January
9 stands for September
O stands for October
N stands for November
D stands for December

- 4)
- 5) 111,112,113,114,116,117,118,119 which is ___ of MPD6D___S
- 6)

⚠ Note:

1. This datasheet is downloaded from the website of Murata Manufacturing co., ltd. Therefore, it's specifications are subject to change or our products in it may be discontinued without advance notice. Please check with our sales representatives or product engineers before ordering.
2. This datasheet has only typical specifications because there is no space for detailed specifications. Therefore, please approve our product specifications or transact the approval sheet for product specifications before ordering.

Pin Number, Function

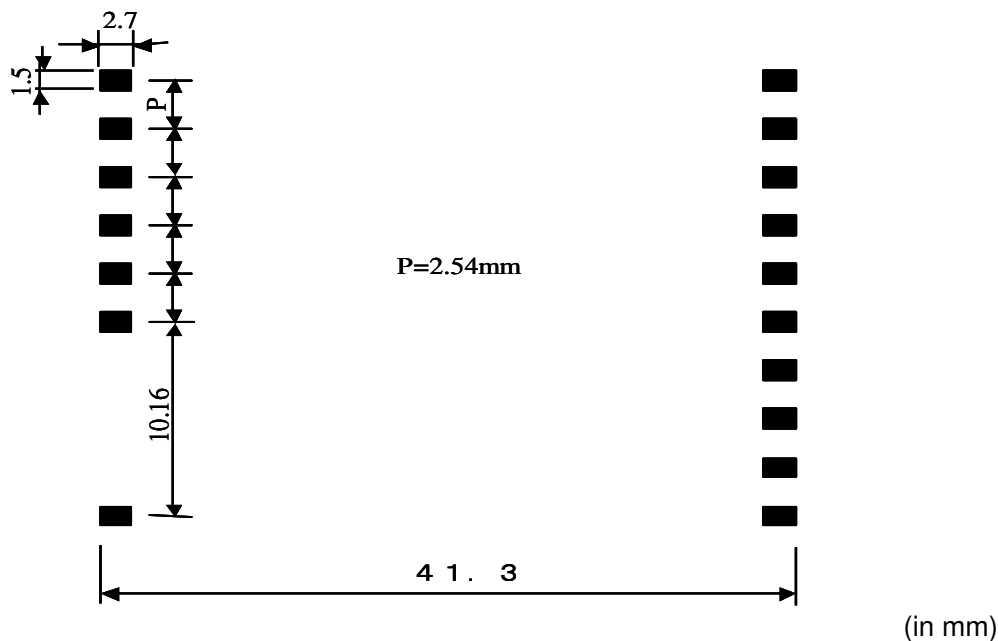
Pin No.	Designation	Function	
1,10,11,20	NC	Not Connected	Note1
15	NC	Not Connected	
12	ALM	Alarm	Note2
13	RC	Remote On/Off Control	
14	PO	Parallel Operation	Note3
18,19	- Vin	- Input	
16,17	+ Vin	+ Input	
2,3,4	+V out	+Output	
5,6	-V out	-Output	

Note 1: It is recommended that pins at the four corners of the substrate be bonded to the assembly board with a thermal setting resin when DC-DC converters are mounted on the assembly board's underside. Otherwise DC-DC converters may fall from the assembly board during the secondary reflow process.

Note 2: Any DC-DC converter halted by abnormal operation forces all DC-DC converters, connected via ALM pins for parallel and/or multiple operation, to discontinue operation.

Note 3: DC-DC converters connected via PO pins can start via synchronized timing for parallel and/or multiple operation.

8. Recommended Solder Land Pattern



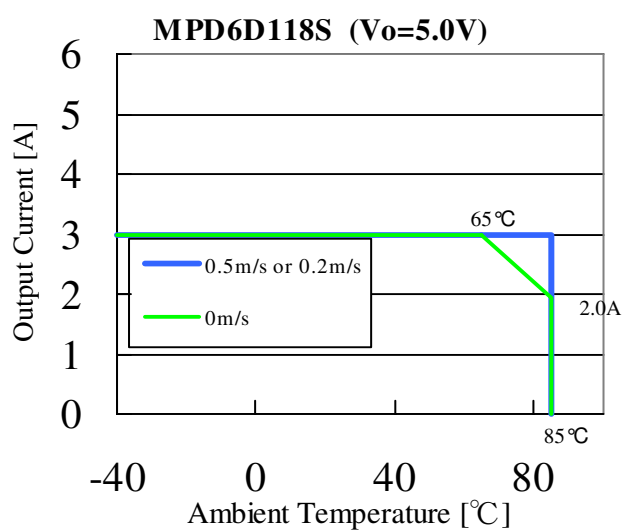
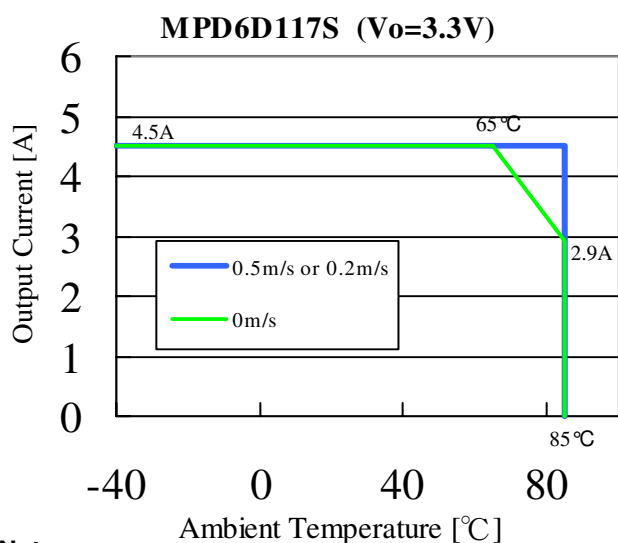
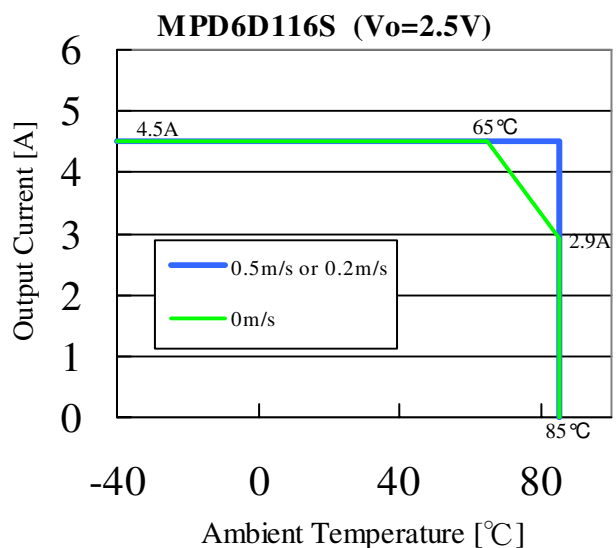
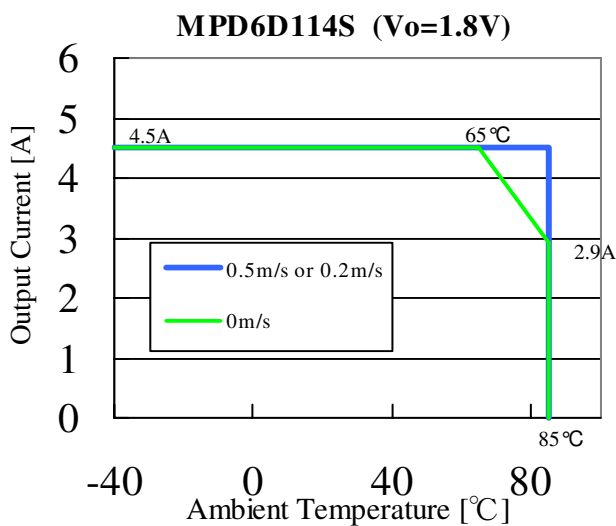
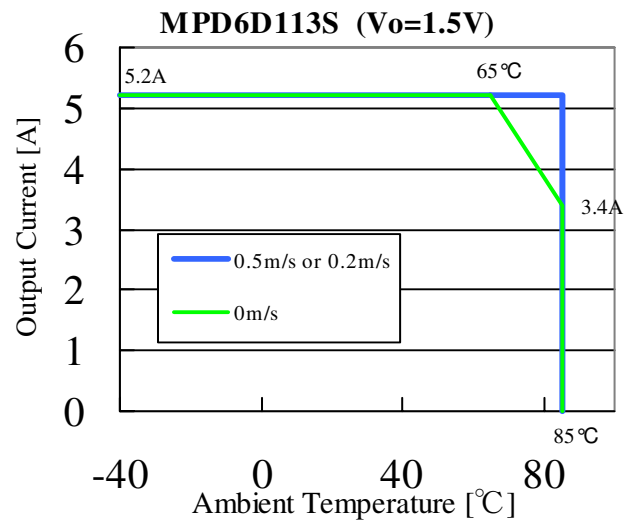
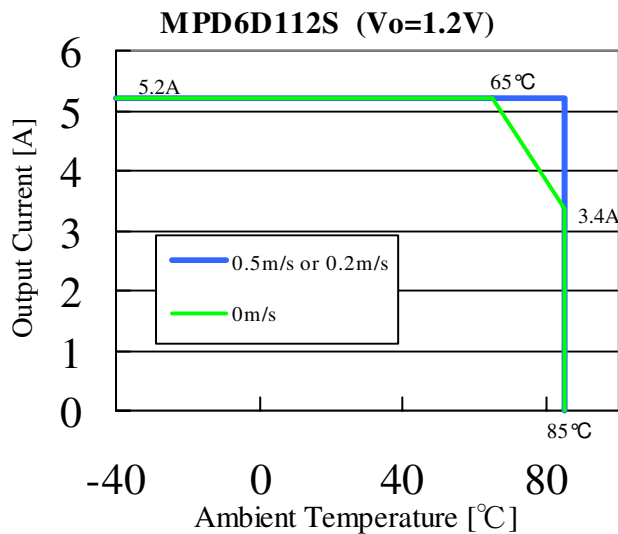
⚠ Note:

1. This datasheet is downloaded from the website of Murata Manufacturing co., ltd. Therefore, it's specifications are subject to change or our products in it may be discontinued without advance notice. Please check with our sales representatives or product engineers before ordering.
2. This datasheet has only typical specifications because there is no space for detailed specifications. Therefore, please approve our product specifications or transact the approval sheet for product specifications before ordering.

9. Temperature Derating

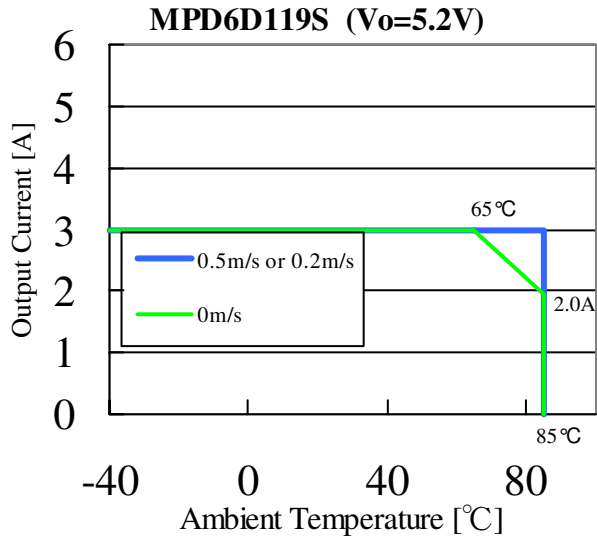
Nominal output currents of MPD6D112S to MD6D119S are attainable with 0.5m/s (100LFM), $V_{in}=36$ to 75V or 0.2m/s (40LFM), $V_{in}=36$ to 60V.

Power deratings are required under 0m/s (0LFM), $V_{in}=36$ to 75V.

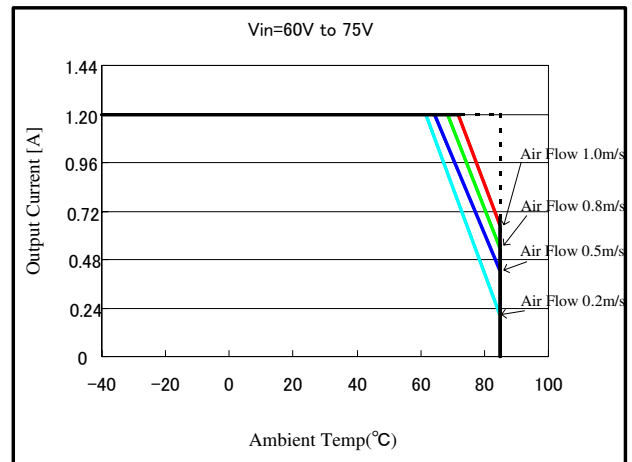
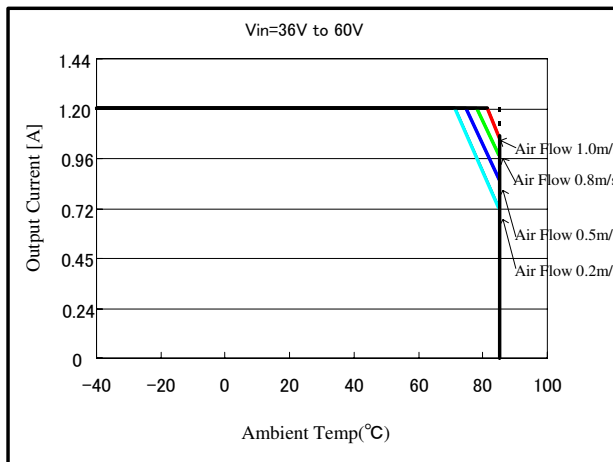


△ Note:

1. This datasheet is downloaded from the website of Murata Manufacturing co., ltd. Therefore, it's specifications are subject to change or our products in it may be discontinued without advance notice. Please check with our sales representatives or product engineers before ordering.
2. This datasheet has only typical specifications because there is no space for detailed specifications. Therefore, please approve our product specifications or transact the approval sheet for product specifications before ordering.



Nominal output current of MPD6D111S is attainable in $V_{in}=36$ to 60V or $V_{in}=60$ to 75V with various air flows of 0.2m/s(40LFM),0.5m/s(100LFM),0.8m/s(160LFM),1.0m/s(200LFM).



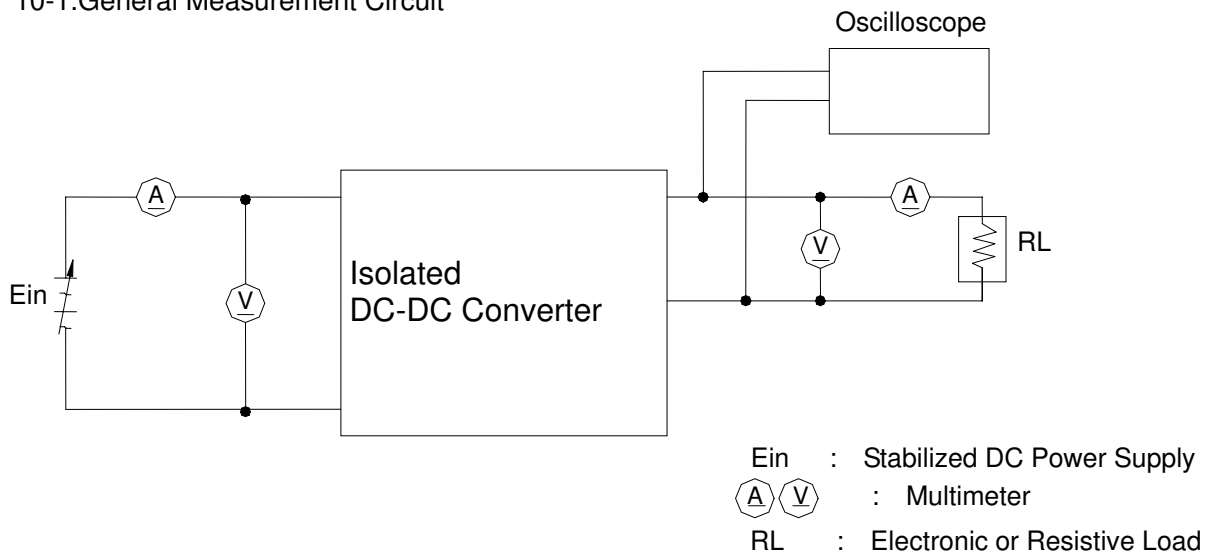
Note:

1. This datasheet is downloaded from the website of Murata Manufacturing co., ltd. Therefore, it's specifications are subject to change or our products in it may be discontinued without advance notice. Please check with our sales representatives or product engineers before ordering.
2. This datasheet has only typical specifications because there is no space for detailed specifications. Therefore, please approve our product specifications or transact the approval sheet for product specifications before ordering.

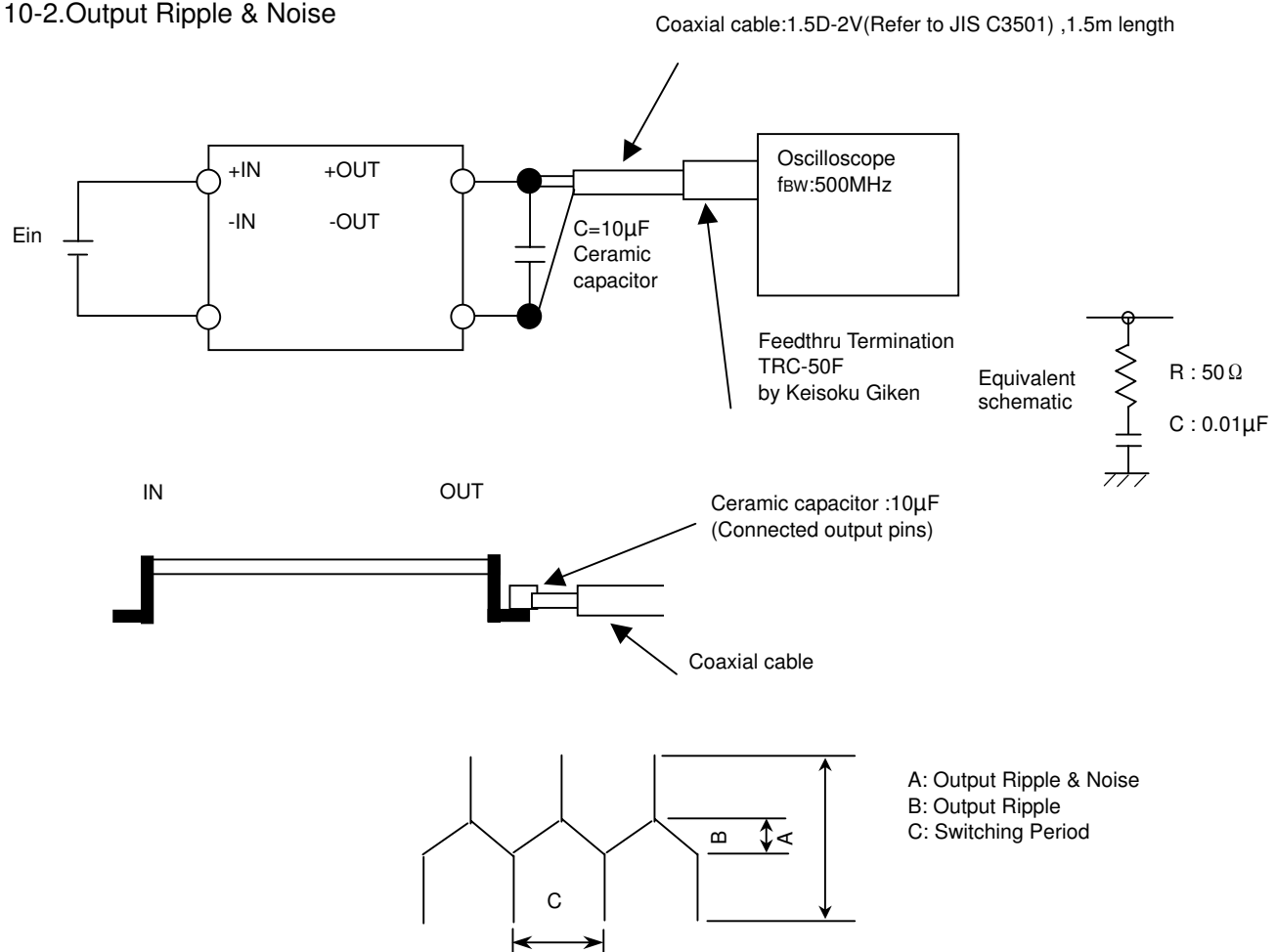
10. Measurement Setup

Please follow the below indicated connections when measurements are conducted. Otherwise measured values may deviate from the specifications.

10-1.General Measurement Circuit



10-2.Output Ripple & Noise



⚠ Note:

1. This datasheet is downloaded from the website of Murata Manufacturing co., ltd. Therefore, it's specifications are subject to change or our products in it may be discontinued without advance notice. Please check with our sales representatives or product engineers before ordering.
2. This datasheet has only typical specifications because there is no space for detailed specifications. Therefore, please approve our product specifications or transact the approval sheet for product specifications before ordering.

11. Characteristics Data

Fig.11-1 to Fig.11-8 expresses the typical characteristics of MPD6D11*S series($T_a=25^\circ\text{C}$)

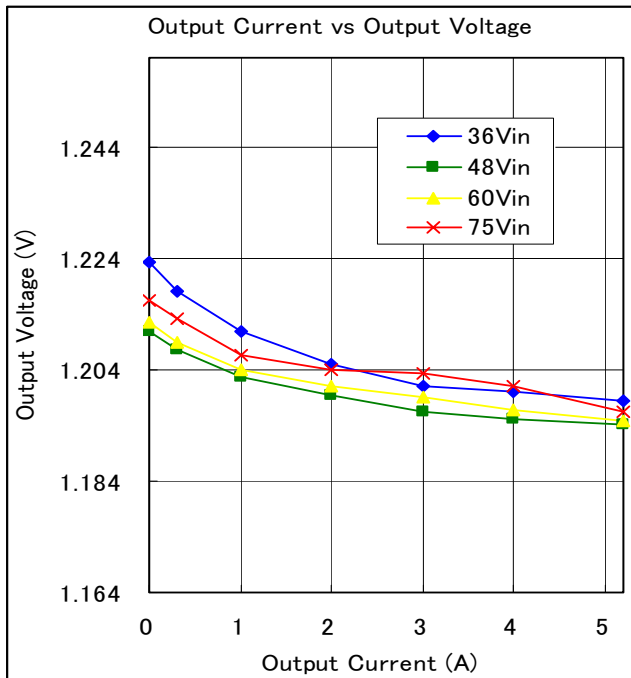
11-1.MPD6D112S (1.2Vout) Characteristics Data ($T_a = 25^\circ\text{C}$, Cout:None)

Fig.11-1-1. Output Voltage vs Output Current

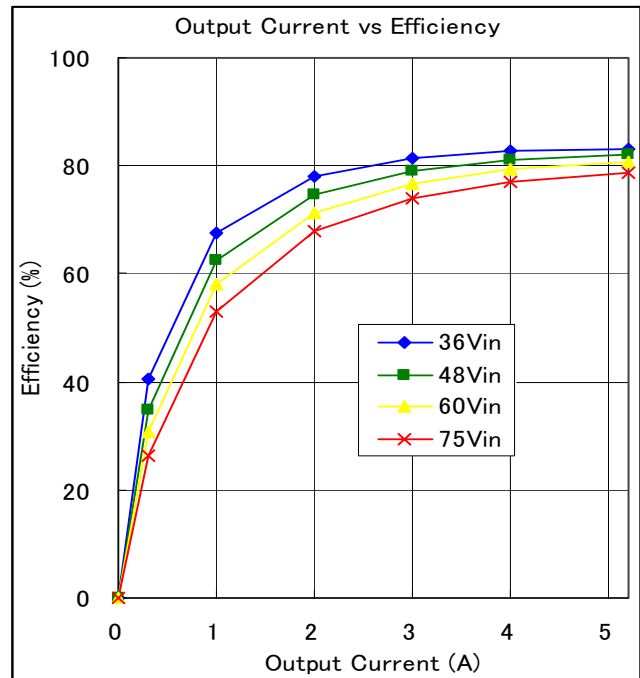


Fig.11-1-2. Efficiency vs Output Current

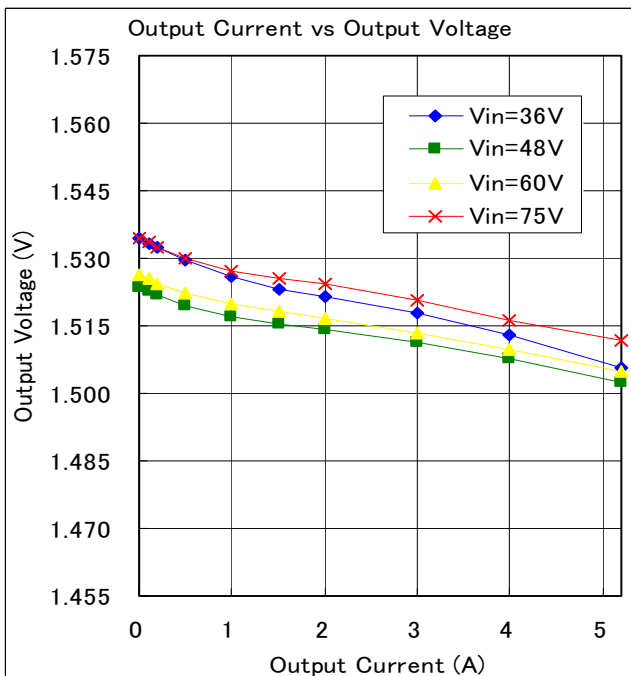
11-2.MPD6D113S (1.5Vout) Characteristics Data ($T_a = 25^\circ\text{C}$, Cout:None)

Fig.11-2-1. Output Voltage vs Output Current

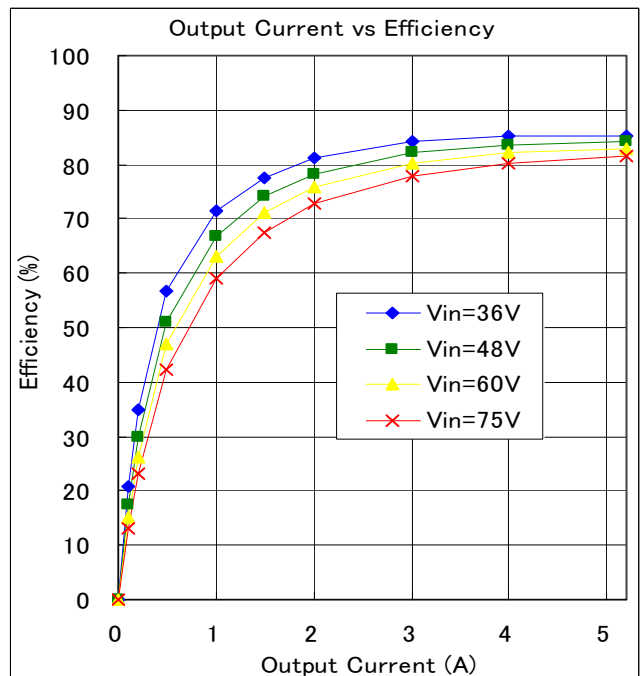


Fig.11-2-2. Efficiency vs Output Current

⚠ Note:

1. This datasheet is downloaded from the website of Murata Manufacturing co., ltd. Therefore, it's specifications are subject to change or our products in it may be discontinued without advance notice. Please check with our sales representatives or product engineers before ordering.
2. This datasheet has only typical specifications because there is no space for detailed specifications. Therefore, please approve our product specifications or transact the approval sheet for product specifications before ordering.

11-3.MPD6D114S (1.8Vout) Characteristics Data (Ta = 25°C, Cout:None)

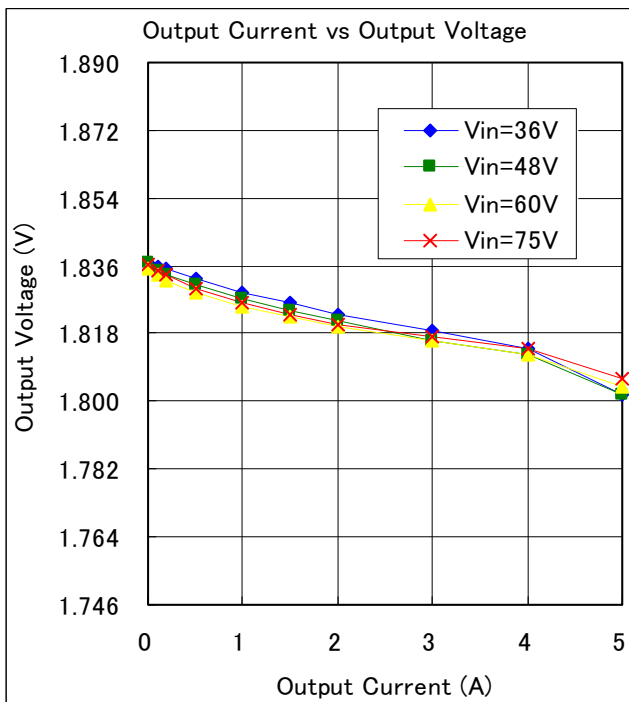


Fig.11-3-1. Output Voltage vs Output Current

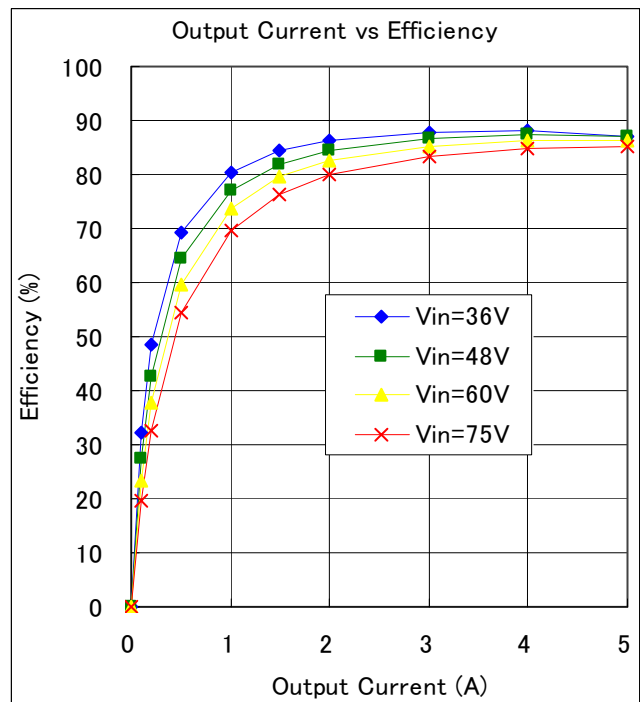


Fig.11-3-2. Efficiency vs Output Current

11-4.MPD6D116S (2.5Vout) Characteristics Data (Ta = 25°C, Cout:None)

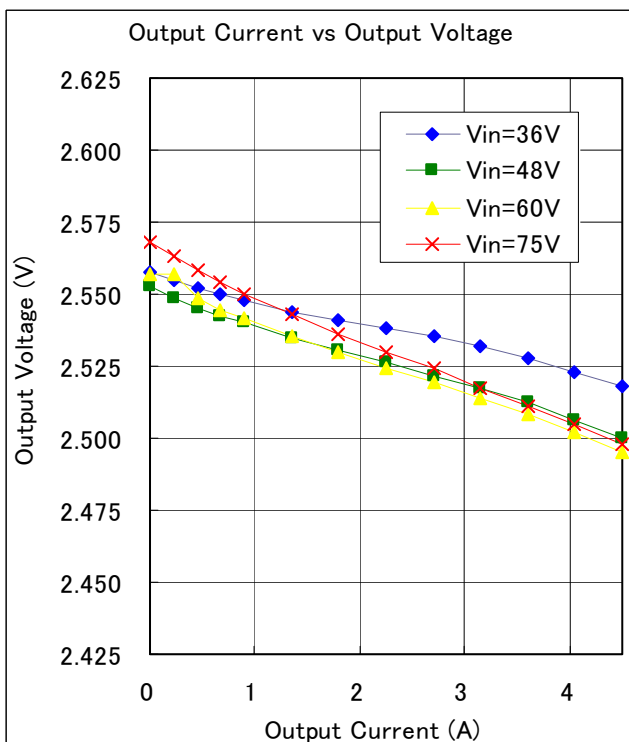


Fig.11-4-1. Output Voltage vs Output Current

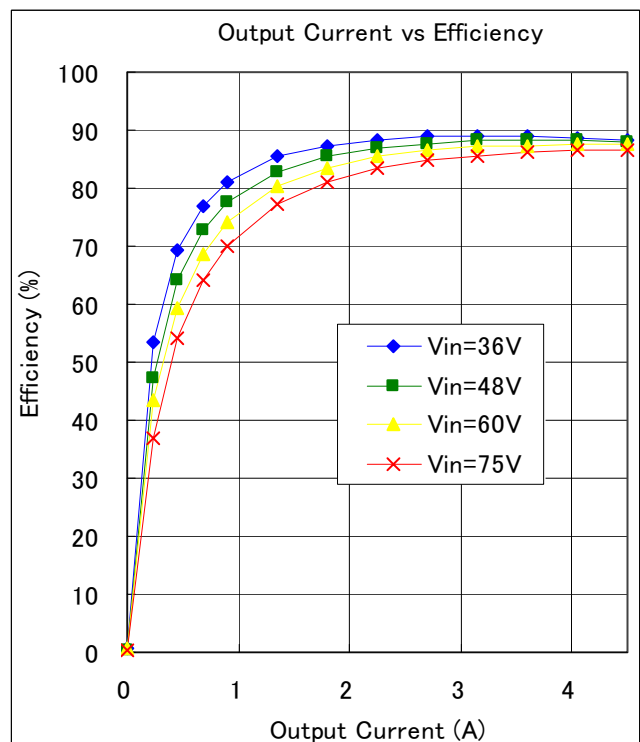


Fig.11-4-2. Efficiency vs Output Current

⚠ Note:

1. This datasheet is downloaded from the website of Murata Manufacturing co., ltd. Therefore, it's specifications are subject to change or our products in it may be discontinued without advance notice. Please check with our sales representatives or product engineers before ordering.
2. This datasheet has only typical specifications because there is no space for detailed specifications. Therefore, please approve our product specifications or transact the approval sheet for product specifications before ordering.

11-5.MPD6D117S (3.3 Vout) Characteristics Data (Ta = 25°C, Cout:None)

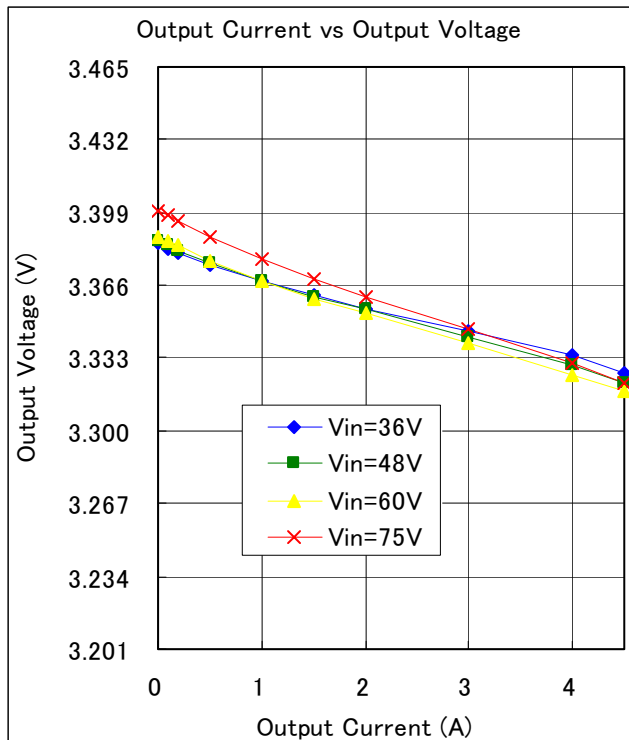


Fig.11-5-1. Output Voltage vs Output Current

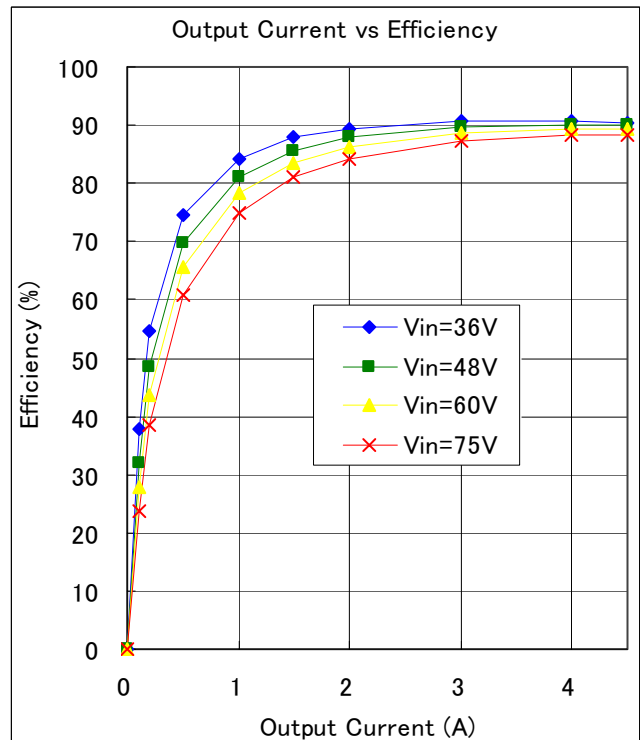


Fig.11-5-2. Efficiency vs Output Current

11-6.MPD6D118S (5.0 Vout) Characteristics Data (Ta = 25°C, Cout:None)

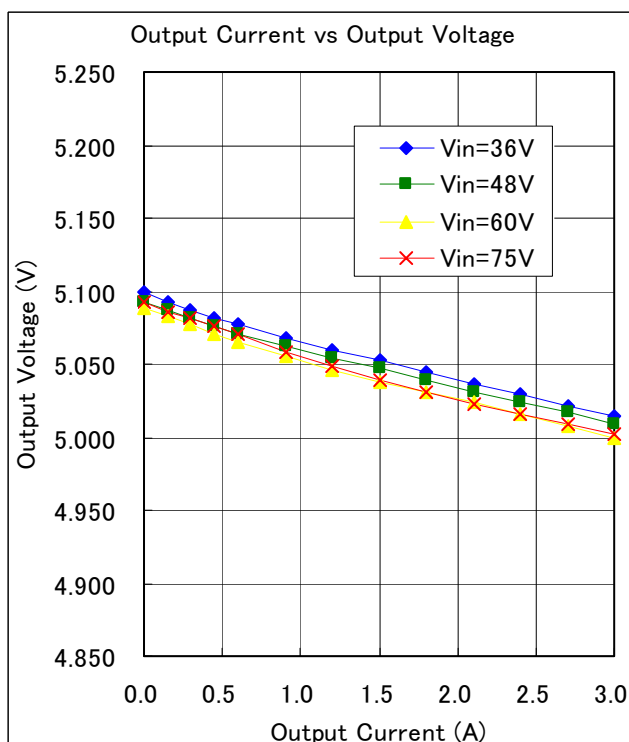


Fig.11-6-1. Output Voltage vs Output Current

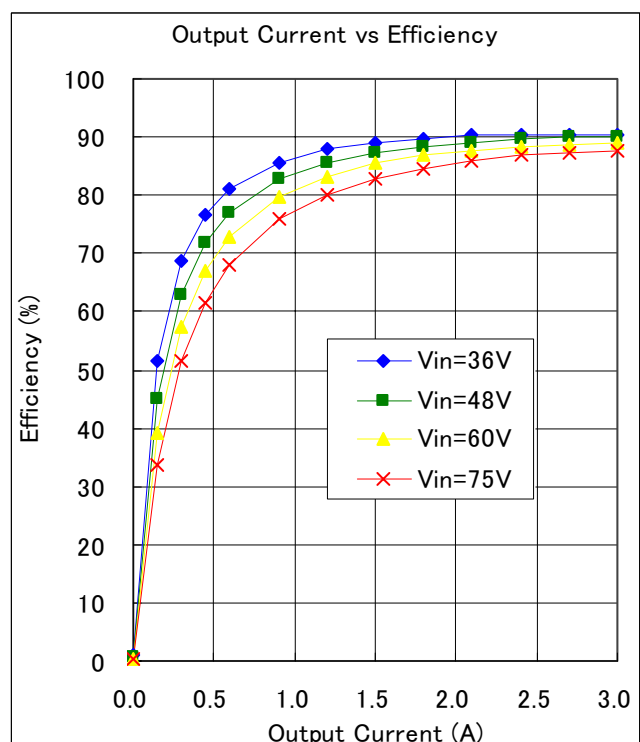


Fig.11-6-2. Efficiency vs Output Current

⚠ Note:

1. This datasheet is downloaded from the website of Murata Manufacturing co., ltd. Therefore, it's specifications are subject to change or our products in it may be discontinued without advance notice. Please check with our sales representatives or product engineers before ordering.
2. This datasheet has only typical specifications because there is no space for detailed specifications. Therefore, please approve our product specifications or transact the approval sheet for product specifications before ordering.

11-7.MPD6D119S (5.2Vout) Characteristics Data (Ta = 25°C, Cout:None)

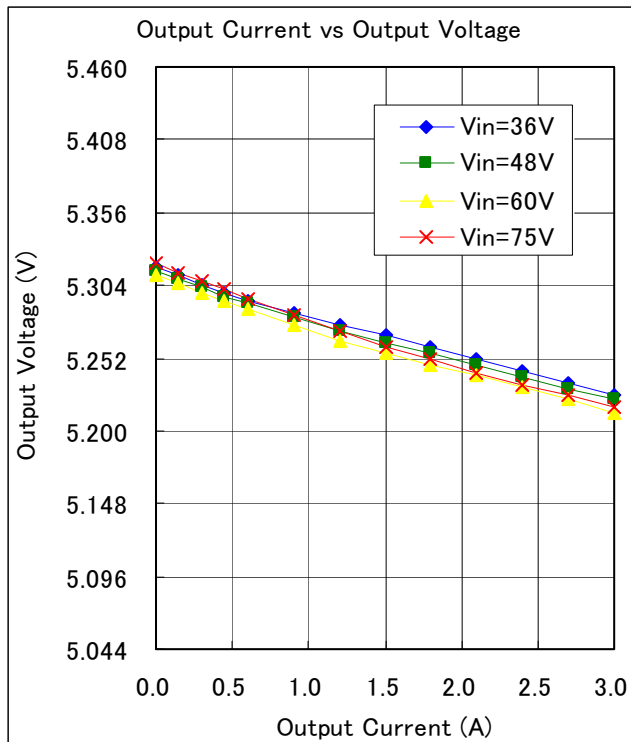


Fig.11-7-1. Output Voltage vs Output Current

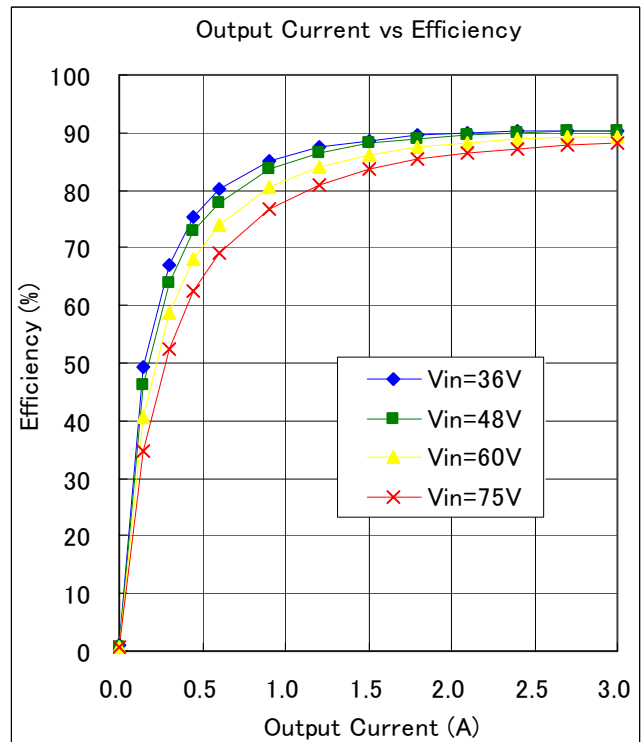


Fig.11-7-2. Efficiency vs Output Current

11-8.MPD6D111S (12.0Vout) Characteristics Data (Ta = 25°C, Cout:None)

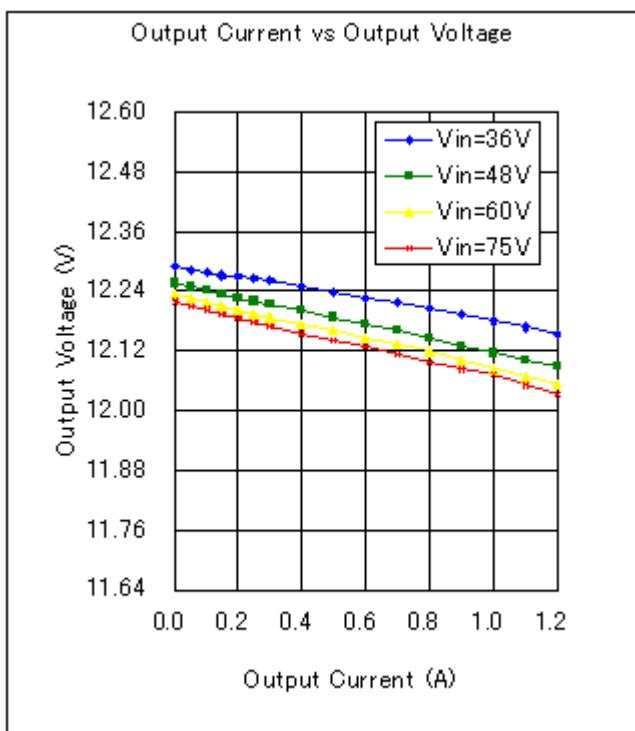


Fig.11-8-1. Output Voltage vs Output Current

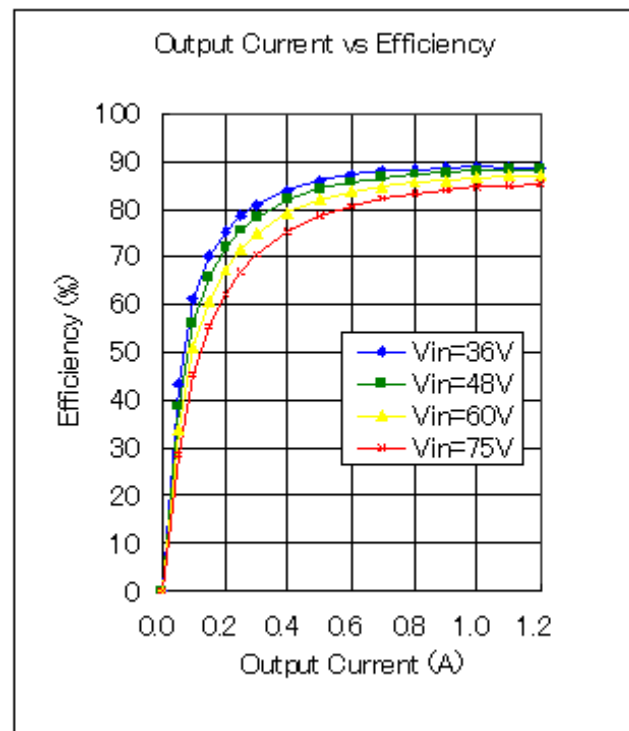


Fig.11-8-2. Efficiency vs Output Current

⚠ Note:

1. This datasheet is downloaded from the website of Murata Manufacturing co., Ltd. Therefore, it's specifications are subject to change or our products in it may be discontinued without advance notice. Please check with our sales representatives or product engineers before ordering.
2. This datasheet has only typical specifications because there is no space for detailed specifications. Therefore, please approve our product specifications or transact the approval sheet for product specifications before ordering.

12. External Input-Output capacitor

<External Input Capacitor>

When an inductance or a switch device are connected to the input line, or when the transient characteristics of the input power supply is unstable, the input voltage may be effected significantly by a sudden change of DC-DC converter load. Because the load response of the DC-DC converter may not be adequately demonstrated by this influence, and the DC-DC converter may cause unusual oscillations in such a case, please connect input capacitors.

<External output capacitor>

When applying an external output capacitor, the total output capacitance should be the following maximum value or less.

Maximum Total External Output Capacitance Value : 400 μ F MAX.

If you use output capacitor exceeding 400 μ F, please contact us.

⚠ < Caution >

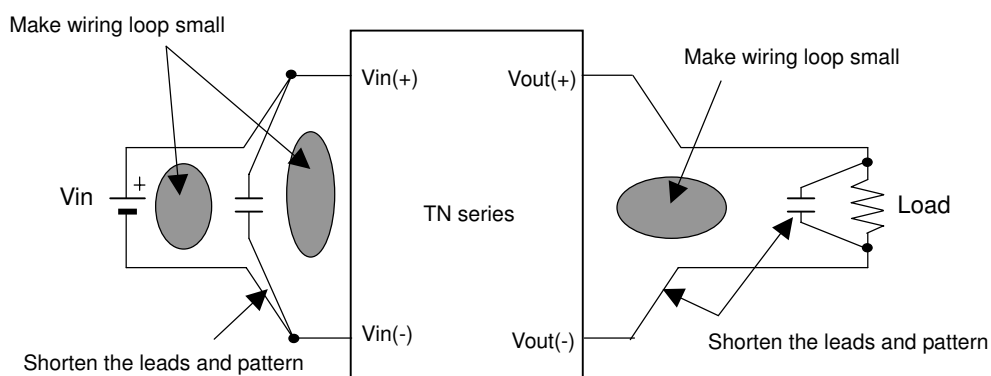
The above capacitance and electrical characteristics are guaranteed under the conditions of measurement via a DC power supply.

When connecting an input inductance or an input power supply that has an output inductance, please confirm the operation including nearby circuitry. Inductance on the input may bring about a possibility that the DC-DC converter may cause unusual oscillation.

Input / Output capacitor

Input / output capacitor connections; in order to minimize noise, please consider the following item when designing a printed circuit board.

- ① Be sure to carry out a system characteristic check.
- ② Use a low impedance capacitor with good high frequency characteristics.
- ③ Shorten the leads of each capacitor as much as possible, and minimize lead inductance.
- ④ On the input and output sides, make the wiring loop between plus and minus as small as possible. This minimizes the influence of any leakage inductance.
- ⑤ Design the print pattern of the main circuit as thickly and as short as possible.

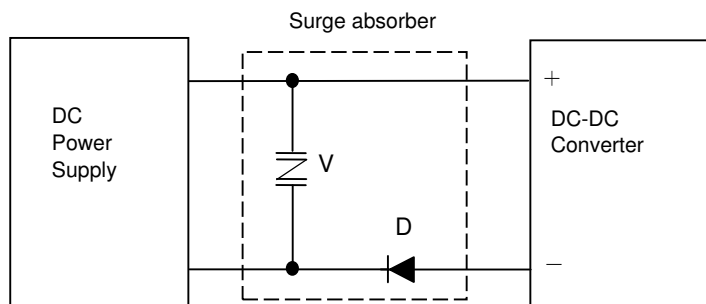


⚠ Note:

1. This datasheet is downloaded from the website of Murata Manufacturing co., ltd. Therefore, it's specifications are subject to change or our products in it may be discontinued without advance notice. Please check with our sales representatives or product engineers before ordering.
2. This datasheet has only typical specifications because there is no space for detailed specifications. Therefore, please approve our product specifications or transact the approval sheet for product specifications before ordering.

13. Caution

- 13.1 This product should not be operated in parallel or series with other DC-DC converters.
- 13.2 Please do not use a connector or a socket for connection to your board of this product. There is a possibility that it cannot satisfy specifications due to the influence of the connector's contact resistance.
- 13.3 Be sure to provide an appropriate fail-safe function on your product to prevent secondary damage that may be caused by abnormal function or failure of the DC_DC converter .
- 13.4 Please connect the input terminals with the correct polarity. If an error in polarity connection is made the DC-DC converter may be damaged. If the DC-DC converter is damaged internally, elevated input current may flow, and so the DC-DC converter may exhibit an abnormal temperature rise, or your product may be damaged. Please add a Diode and Varistor per the following diagram to protect them.



Diode : FCF0A40
(Nihon Inter Corporation)

Varistor : NVD14SC082
(KOA)

Please select Diode and Varistor after confirming the operation.

⚠ Note

1. Please contact our main sales office or nearby sales office before using our products for the applications listed below which require especially high reliability for the prevention of defects which might directly cause damage to the third party's life, body or property or this products for any other applications that described in the above.

Aircraft equipment
Aerospace equipment
Undersea equipment
Power plant control equipment
Medical equipment
Transportation equipment (vehicles, trains, ships, etc.)
Traffic signal equipment
Disaster prevention /crime prevention equipment
Data-processing equipment

Application of similar complexity and/or reliability requirements to the applications listed in the above.

2. This was released in July, 2006. The contents, are subject to change without notice, Please confirm specifications when ordering. If there are questions regarding the contents, please ask to our main sales office or nearby sales office.
3. Types and specification in this document are referenced for your information only. Please confirm detailed specifications by approving our individual drawing and specification sheet.

⚠ Note:

1. This datasheet is downloaded from the website of Murata Manufacturing co., ltd. Therefore, it's specifications are subject to change or our products in it may be discontinued without advance notice. Please check with our sales representatives or product engineers before ordering.
2. This datasheet has only typical specifications because there is no space for detailed specifications. Therefore, please approve our product specifications or transact the approval sheet for product specifications before ordering.