

Typical unit



Output (V)	Current (A)	Nominal Input (V)
3.3	7.575	D48 = 36-75V (48V nom)
5	5	
12	2.1	

FEATURES

- 2:1 Input voltage range (D48 = 36-75V)
- 1" x 1" x 0.41" dimensions.
- Adjustable Vout (+10% to -10%)
- High efficiency
- Positive & negative logic, remote on/off control option
- Monotonic startup into pre-bias output conditions
- Continuous short circuit protection
- Over-temperature protection
- Over-voltage protection
- Low output ripple and noise
- Strong thermal derating characteristics
- Operational temperature range -40°C to +85°C
- 1600V I/O isolation
- Packaged in a five-sided EMI shielding metal package with non-conductive base
- Certified to UL 60950-1, CAN/CSA-C22.2 No. 60950-1, IEC60950-1 safety approvals, 2nd edition, with AM1

PRODUCT OVERVIEW

The SPM25 series isolated DC-DC converters represent the next generation in Industrial Potted Module Technology. Featuring a full 25-Watt output in one square inch of board area, the SPM25 series isolated DC-DC converter family offers efficient regulated DC power for printed circuit board mounting. The 1" x 1" x 0.41" (25.4 x 25.4 x 10.41 mm) converter accepts a 2:1 input voltage range of 36 to 75 Volts (D48), ideal for industrial applications.

Intended target markets include transportation, medical systems, electronic test equipment, industrial processing equipment, industrial applications where power modules must meet rugged environmental requirements, high power density, and

where isolated output voltages are required. These converters offer a feature/option set including: through-hole mounting, positive or negative logic (remote on/off), over-current & over-temperature protection, under-voltage lockout. The input voltage range covers the standard Industrial requirements with a regulated output voltage and power rating up to 25W.

Modules provide voltage isolation (basic insulation) from input to output of up to 1600V. The Operating ambient temperature range is -40°C to +85°C. The module delivers full output power to +70°C with no airflow. These parts are ideal for applications that do not require any heat sinking or forced air cooling.

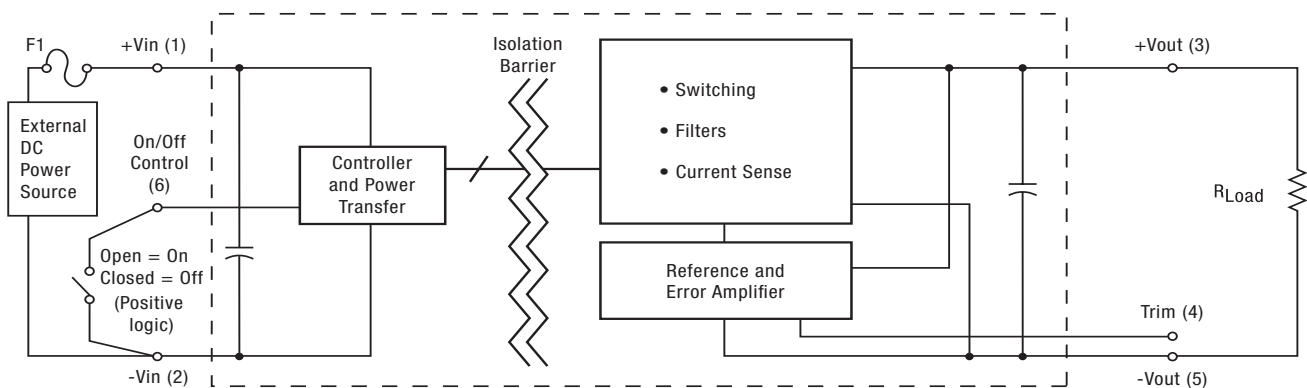

Figure 1. Connection Diagram

Typical topology is shown. Murata Power Solutions recommends an external fuse.



For full details go to
www.murata-ps.com/rohs



(pending)

PERFORMANCE SPECIFICATIONS SUMMARY AND ORDERING GUIDE ① ③															
Root Models ①	Output							Input				Efficiency		Dimensions	
	V _{OUT} (V)	I _{OUT} (A, max)	Total Power (W)	R/N (mVp-p)		Regulation (Max.)		V _{IN} Nom. (V)	Range (V)	I _{IN} , no load (mA)	I _{IN} , full load (A)	Min.	Typ.	Case (inches)	Case (mm)
				Typ. ②	Max.	Line	Load								
SPM25-033-D48	3.3	7.575	25	50	80	±0.1%	±0.2%	48	36-75	75	0.58	87%	89.5%	1.0" x 1.0" x 0.41"	25.4 x 25.4 x 10.41
SPM25-050-D48	5	5	25	50	80	±0.1%	±0.2%	48	36-75	30	0.57	88.3%	91.0%	1.0" x 1.0" x 0.41"	25.4 x 25.4 x 10.41
SPM25-120-D48	12	2.1	25.2	65	120	±0.1%	±0.125%	48	36-75	20	0.6	85.0%	87%	1.0" x 1.0" x 0.41"	25.4 x 25.4 x 10.41

- Notes:**
- ① Please refer to the part number structure for additional options and complete ordering part numbers.
 - ② Ripple and Noise is shown at 20 MHz bandwidth.
 - ③ All specifications are at nominal line voltage and full load, +25 °C. unless otherwise noted. See detailed specifications for full conditions. Output capacitors are 1 µF in parallel with 10 µF. The input cap is 4.7 µF (SPM25-120-D48) and 22 µF (SPM25-033-D48, SPM25-050-D48), low ESR.

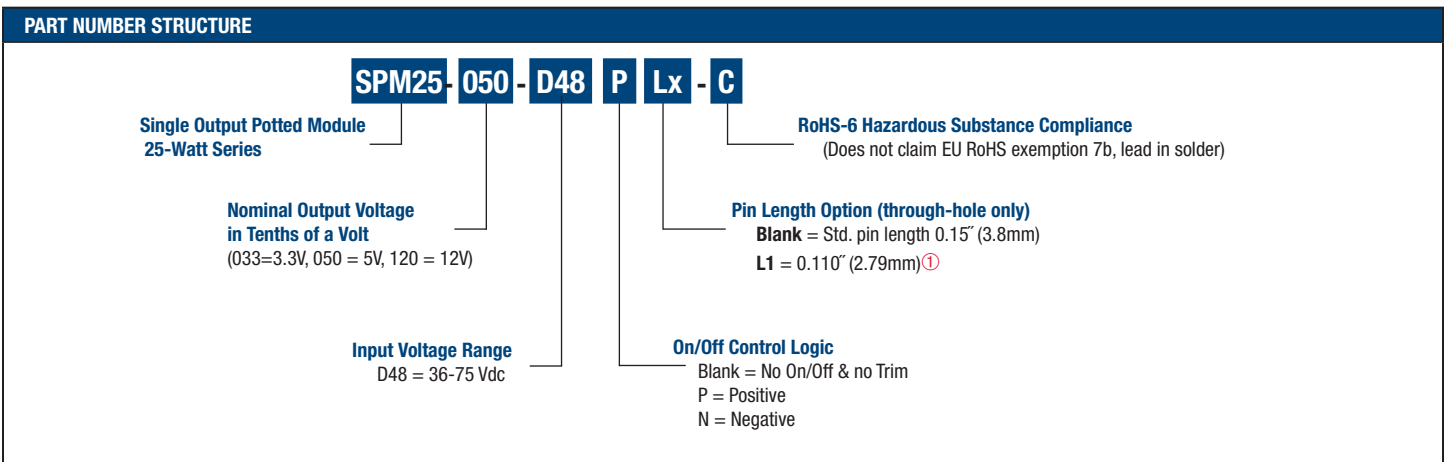

- ① **Special quantity order is required; samples available with standard pin length only.**
- ② **Some model number combinations may not be available. See website or contact your local Murata sales representative.**

FUNCTIONAL SPECIFICATIONS – MODEL SPM25-033-D48

ABSOLUTE MAXIMUM RATINGS	Conditions ①	Minimum	Typical/Nominal	Maximum	Units
Input Voltage, Continuous		0		80	Vdc
Input Voltage, Transient	100 mS max. duration			100	Vdc
Isolation Voltage	Input to output, continuous			1600	Vdc
On/Off Remote Control	Power on, referred to -Vin	0		15	Vdc
Output Power		0		25.25	W
Output Current	Current-limited, no damage, short-circuit protected	0.7575		7.575	A
Storage Temperature Range	Vin = Zero (no power)	-55		125	°C
Absolute maximums are stress ratings. Exposure of devices to greater than any of these conditions may adversely affect long-term reliability. Proper operation under conditions other than those listed in the Performance/Functional Specifications Table is not implied or recommended.					
INPUT					
Operating voltage range		36	48	75	Vdc
Recommended External Fuse	Fast blow			1.5	A
Start-up threshold	Rising input voltage	34	35.2	36	Vdc
Undervoltage shutdown	Falling input voltage	32	34	35.2	Vdc
Turn-On/Turn-Off Hysteresis			1.5		Vdc
Internal Filter Type			LC		
Input current					
Full Load Input Current	Vin = nominal		0.58	0.6	A
Low Line Input Current	Vin = minimum		0.79	0.81	A
Inrush Transient			0.05		A ² -Sec.
Short Circuit Input Current			50	100	mA
No Load Input Current	Iout = minimum, unit = ON		75	100	mA
Shut-Down Input Current (Off, UV, OT)			1	2	mA
Reflected (back) ripple current ②	Measured at input with specified filter		30		mA, p-p
GENERAL and SAFETY					
Efficiency	Vin = 48V, full load	87	89.5		%
	Vin = min., full load	86.5	57.5		%
Isolation					
Isolation Voltage	Input to output, continuous	1600			Vdc
Insulation Safety Rating			basic		
Isolation Resistance			10		MΩ
Isolation Capacitance			1000		pF
Safety	Certified to UL-60950-1, CSA-C22.2 No. 60950-1, IEC60950-1, 2nd edition, with AM1		Yes		
Calculated MTBF	Per Telcordia SR332, issue 1, class 3, ground fixed, Tambient = +25°C		TBD		Hours x 10 ⁶
DYNAMIC CHARACTERISTICS					
Fixed Switching Frequency		300	330	360	KHz
Startup Time	Power on to Vout regulated			50	mS
Startup Time	Remote ON to Vout regulated			50	mS
Dynamic Load Response	50-75-50% load step, settling time to within 2% of Vout		180	250	μSec
Dynamic Load Peak Deviation	same as above		±30	±100	mV
FEATURES and OPTIONS					
Remote On/Off Control ③					
"N" suffix					
Negative Logic, ON state	ON = Ground pin or external voltage	-0.7		0.8	V
Negative Logic, OFF state	OFF = Pin open or external voltage	10		15	V
Control Current	Open collector/drain		1		mA
"P" suffix					
Positive Logic, ON state	ON = Pin open or external voltage	10		15	V
Positive Logic, OFF state	OFF = Ground pin or external voltage	-0.7		0.7	V
Control Current	Open collector/drain		1		mA

FUNCTIONAL SPECIFICATIONS (CONT.) – MODEL SPM25-033-D48

OUTPUT	Conditions ①	Minimum	Typical/Nominal	Maximum	Units
Total Output Power	See Derating	0.0	25	25.25	W
Voltage					
Nominal Output Voltage	No trim	3.267	3.3	3.333	Vdc
Setting Accuracy	At 50% load, no trim	-1		1	% of Vnom
Output Voltage Range	User-adjustable	-10		10	% of Vnom.
Overvoltage Protection	Via magnetic feedback	4.2	5	5.7	Vdc
Current					
Output Current Range		0.7575	7.575	7.575	A
Current Limit Inception	98% of Vnom., after warmup	8	10	11.3	A
Short Circuit					
Short Circuit Current	Hiccup technique, autorecovery within $\pm 1.25\%$ of Vout			0.3	A
Short Circuit Duration (remove short for recovery)	Output shorted to ground, no damage		Continuous		
Short circuit protection method	Current limiting				
Regulation					
Line Regulation	Vin = min. to max., Vout = nom., Iout = nom.			± 0.1	% of Vout
Load Regulation	Iout = min. to max., Vin = 48V			± 0.2	% of Vout
Ripple and Noise	5 Hz - 20 MHz BW		50	80	mV pk-pk
Temperature Coefficient	At all outputs		± 0.02		% of Vnom./°C
Maximum Capacitive Loading	Low ESR, resistive load only			2000	μF
MECHANICAL					
Outline Dimensions			1" x 1" x 0.41"		Inches
(Please refer to outline drawing)	WxLxH		25.4 x 25.4 x 10.41 mm		mm
Weight			0.69		Ounces
			19.56		Grams
Through Hole Pin Diameter			0.04		Inches
			1.016		mm
Through Hole Pin Material			Copper alloy		
TH Pin Plating Metal and Thickness	Nickel subplate		50		$\mu\text{-inches}$
	Gold overplate		5		$\mu\text{-inches}$
ENVIRONMENTAL					
Operating Ambient Temperature Range	See derating	-40		85	°C
Operating Case Temperature Range	No derating	-40		105	°C
Case Material	Tin plated steel with black powder coat				
Storage Temperature	Vin = Zero (no power)	-55		125	°C
Thermal Protection/Shutdown	Measured in center	110	115	120	°C
Electromagnetic Interference	External filter is required				
Conducted, EN55022/CISPR22			B		Class
Radiated, EN55022/CISPR22			B		Class
RoHS rating			RoHS-6		

Notes

- ① Unless otherwise noted, all specifications are at nominal input voltage, nominal output voltage and full load. General conditions are +25° Celsius ambient temperature, near sea level altitude, natural convection airflow. All models are tested and specified with external parallel 1 μF and 10 μF output capacitors. The external input capacitor is 22 μF . All capacitors are low-ESR types wired close to the converter.
- ② Input (back) ripple current is tested and specified over 5 Hz to 20 MHz bandwidth. Input filtering is Cbus=220 μF , Cin=33 μF and Lbus=12 μH .
- ③ The Remote On/Off Control is referred to -Vin.

TYPICAL PERFORMANCE DATA, SPM25-033-D48

Efficiency vs. Line Voltage and Load Current @ 25°C

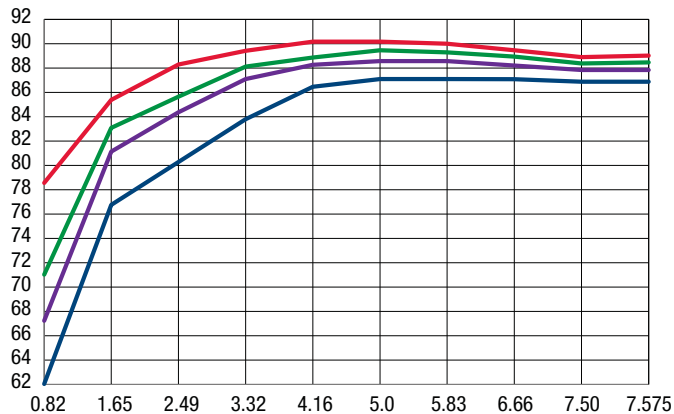

Power Dissipation

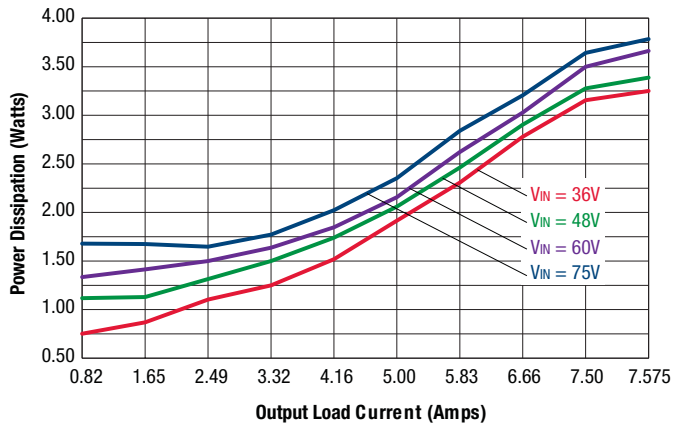

Maximum Current Temperature Derating at sea level
V_{in} = 36 (air flow from J1 to J3 on PCB)

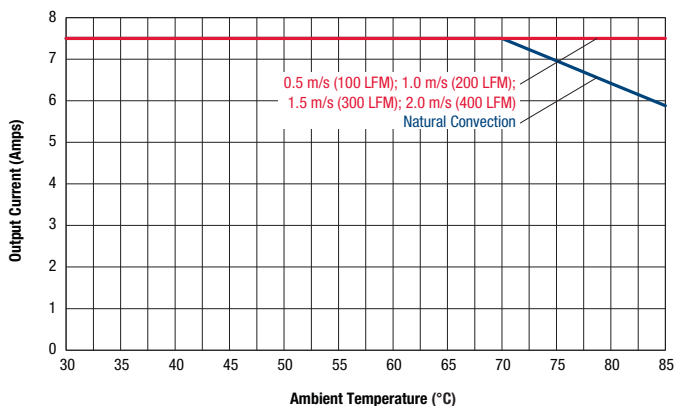

Maximum Current Temperature Derating at sea level
V_{in} = 48 (air flow from J1 to J3 on PCB)

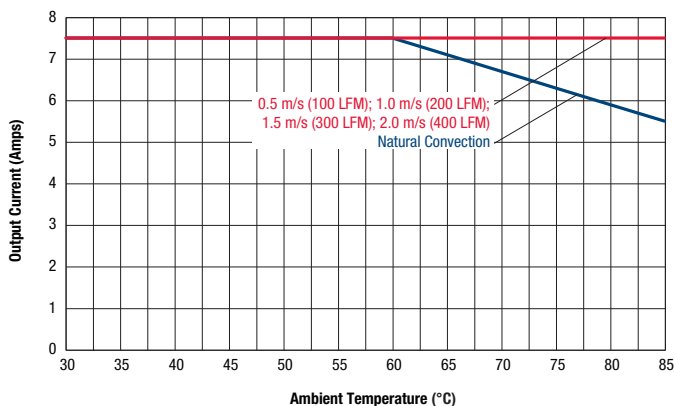

Maximum Current Temperature Derating at sea level
V_{in} = 60 (air flow from J1 to J3 on PCB)

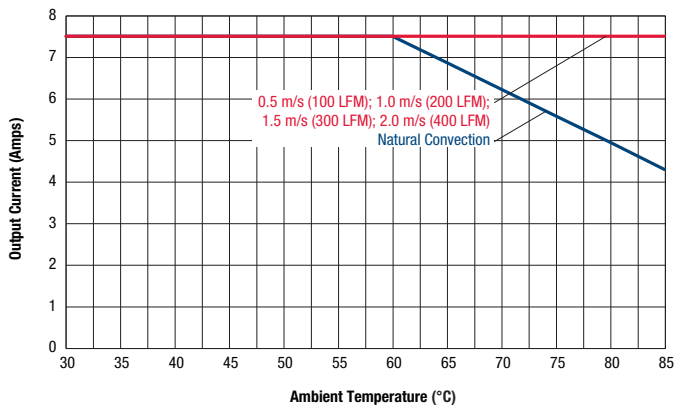

Maximum Current Temperature Derating at sea level
V_{in} = 75 (air flow from J1 to J3 on PCB)

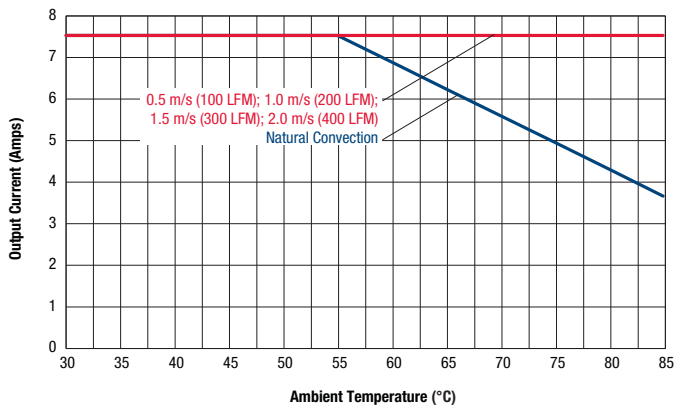

TYPICAL PERFORMANCE DATA, SPM25-033-D48

Start-up Delay(Vin=48V, Iout=7.5A, Ta=+25°C) Ch1=Vin, Ch4=Vout

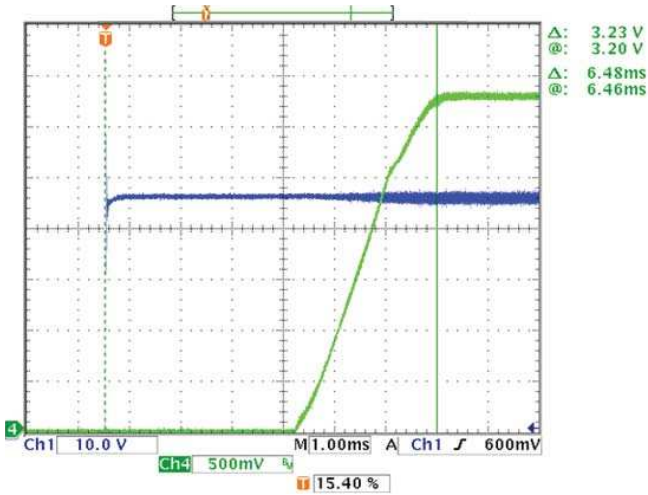

Enable Start-up Delay(Vin=48V, Iout=7.5A, Ta=+25°C) Ch1=Enable, Ch4=Vout

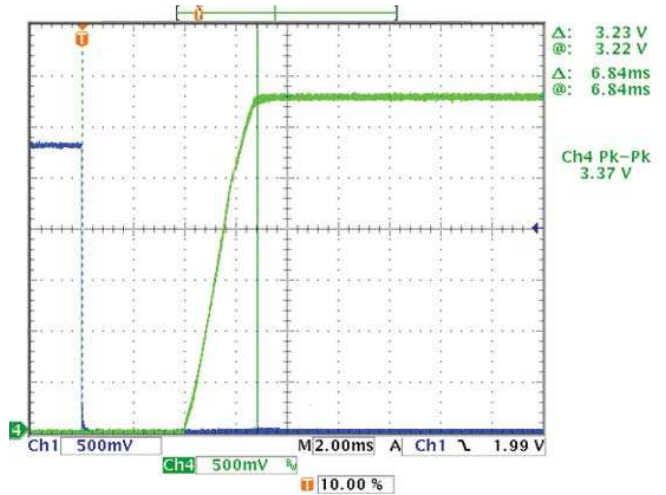

Output Ripple and Noise (Vin = 48V, Io = 0A, Cload = 1μF || 10μF, Ta = +25°C)

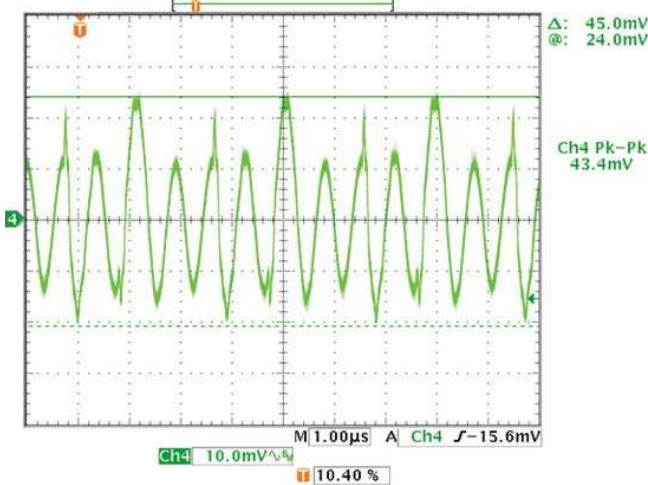

Output Ripple and Noise (Vin = 48V, Io = 7.5A, Cload = 1μF || 10μF, Ta = +25°C)

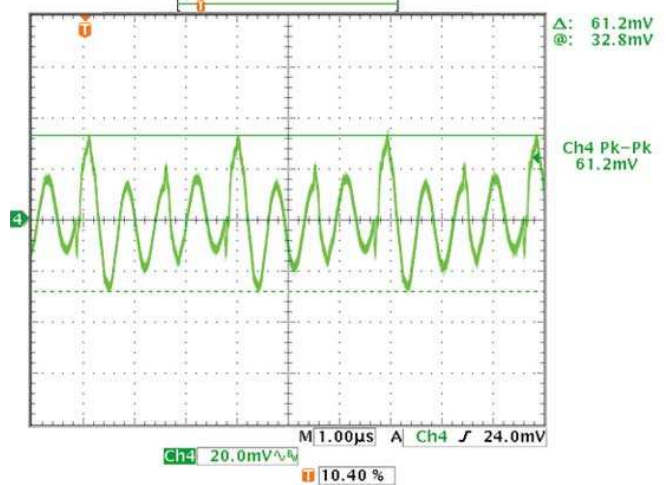

Step Load Transient Response(Vin=48V, Vout=nom, Iout=50 to 100% of full load, Cout=1μF || 10μF)

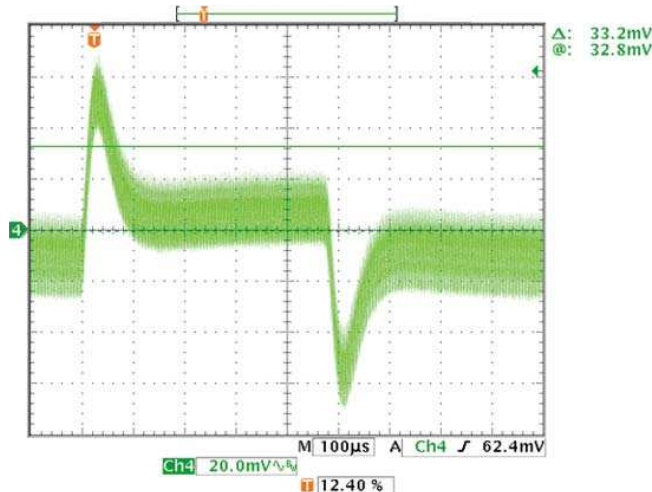

FUNCTIONAL SPECIFICATIONS – MODEL SPM25-050-D48

ABSOLUTE MAXIMUM RATINGS	Conditions ①	Minimum	Typical/Nominal	Maximum	Units
Input Voltage, Continuous		0		80	Vdc
Input Voltage, Transient	100 mS max. duration			100	Vdc
Isolation Voltage	Input to output, continuous			1600	Vdc
On/Off Remote Control	Power on, referred to -Vin	0		15	Vdc
Output Power		0		25.25	W
Output Current	Current-limited, no damage, short-circuit protected	0		5	A
Storage Temperature Range	Vin = Zero (no power)	-55		125	°C
Absolute maximums are stress ratings. Exposure of devices to greater than any of these conditions may adversely affect long-term reliability. Proper operation under conditions other than those listed in the Performance/Functional Specifications Table is not implied or recommended.					
INPUT					
Operating voltage range		36	48	75	Vdc
Recommended External Fuse	Fast blow			1.5	A
Start-up threshold	Rising input voltage	33	34	35	Vdc
Undervoltage shutdown	Falling input voltage	31.5	32.5	34.5	Vdc
Turn-On/Turn-Off Hysteresis			1.5		Vdc
Internal Filter Type			LC		
Input current					
Full Load Input Current	Vin = nominal		0.57	0.6	A
Low Line Input Current	Vin = minimum		0.76	0.79	A
Inrush Transient			0.05		A ² -Sec.
Short Circuit Input Current			50	100	mA
No Load Input Current	Iout = minimum, unit=ON		30	50	mA
Shut-Down Input Current (Off, UV, OT)			1	3	mA
Reflected (back) ripple current ②	Measured at input with specified filter		30		mA, p-p
Pre-biased startup	External output voltage < Vset		Monotonic		
GENERAL and SAFETY					
Efficiency	Vin = 48V, full load	88.3	91		%
	Vin = min., full load	88.5	91		%
Isolation					
Isolation Voltage	Input to output, continuous	1600			Vdc
Insulation Safety Rating			basic		
Isolation Resistance			10		MΩ
Isolation Capacitance			2000		pF
Safety	Certified to UL-60950-1, CSA-C22.2 No. 60950-1, IEC60950-1, 2nd edition, with AM1		Yes		
Calculated MTBF	Per Telcordia SR332, issue 1, class 3, ground fixed, Tambient = +25°C		TBD		Hours x 10 ⁶
DYNAMIC CHARACTERISTICS					
Fixed Switching Frequency		300	330	360	KHz
Startup Time	Power on to Vout regulated			50	mS
Startup Time	Remote ON to Vout regulated			50	mS
Dynamic Load Response	50-75-50% load step, settling time to within 1% of Vout		50	100	μSec
Dynamic Load Peak Deviation	same as above		±75	±125	mV
FEATURES and OPTIONS					
Remote On/Off Control ③					
"N" suffix					
Negative Logic, ON state	ON = Ground pin or external voltage	-0.7		0.8	V
Negative Logic, OFF state	OFF = Pin open or external voltage	10		15	V
Control Current	Open collector/drain		1		mA
"P" suffix					
Positive Logic, ON state	ON = Pin open or external voltage	10		15	V
Positive Logic, OFF state	OFF = Ground pin or external voltage	-0.7		0.7	V
Control Current	Open collector/drain		1		mA

FUNCTIONAL SPECIFICATIONS (CONT.) – MODEL SPM25-050-D48

OUTPUT	Conditions ①	Minimum	Typical/Nominal	Maximum	Units
Total Output Power	See Derating	0.0	25	25.25	W
Voltage					
Nominal Output Voltage	No trim	4.95	5	5.05	Vdc
Setting Accuracy	At 50% load, no trim	-1		1	% of Vset
Output Voltage Range	User-adjustable	-10		10	% of Vnom
Overvoltage Protection	Via magnetic feedback	6	6.5	7.5	Vdc
Current					
Output Current Range		0	5	5	A
Minimum Load			No minimum load		% of Iout
Current Limit Inception	98% of Vnom., after warmup	5.3	7.05	8.3	A
Short Circuit					
Short Circuit Current	Hiccup technique, autorecovery within ±1.25% of Vout			0.3	A
Short Circuit Duration (remove short for recovery)	Output shorted to ground, no damage		Continuous		
Short circuit protection method	Current limiting				
Regulation					
Line Regulation	Vin = min. to max., Vout = nom., Iout = nom.			±0.1	% of Vout
Load Regulation	Iout = min. to max., Vin = 48V			±0.2	% of Vout
Ripple and Noise	5 Hz - 20 MHz BW		50	80	mV pk-pk
Temperature Coefficient	At all outputs		±0.02		% of Vnom./°C
Maximum Capacitive Loading	Low ESR, resistive load only			2000	µF
MECHANICAL					
Outline Dimensions			1" x 1" x 0.41"		Inches
(Please refer to outline drawing)	WxLxH		25.4 x 25.4 x 10.41 mm		mm
Weight			0.69		Ounces
			19.56		Grams
Through Hole Pin Diameter			0.04		Inches
			1.016		mm
Through Hole Pin Material			Copper alloy		
TH Pin Plating Metal and Thickness	Nickel subplate		50		µ-inches
	Gold overplate		5		µ-inches
ENVIRONMENTAL					
Operating Ambient Temperature Range	See derating	-40		85	°C
Operating Case Temperature Range	No derating	-40		105	°C
Case Material	Tin plated steel with black powder coat				
Storage Temperature	Vin = Zero (no power)	-55		125	°C
Thermal Protection/Shutdown	Measured in center	110	115	120	°C
Electromagnetic Interference	External filter is required				
Conducted, EN55022/CISPR22			B		Class
Radiated, EN55022/CISPR22			B		Class
RoHS rating			RoHS-6		

Notes

- ① Unless otherwise noted, all specifications are at nominal input voltage, nominal output voltage and full load. General conditions are +25° Celsius ambient temperature, near sea level altitude, natural convection airflow. All models are tested and specified with external parallel 1 µF and 10 µF output capacitors. The external input capacitor is 22 µF. All capacitors are low-ESR types wired close to the converter.
- ② Input (back) ripple current is tested and specified over 5 Hz to 20 MHz bandwidth. Input filtering is Cbus=220 µF, Cin=33 µF and Lbus=12 µH.
- ③ The Remote On/Off Control is referred to -Vin.

TYPICAL PERFORMANCE DATA, SPM25-050-D48

Efficiency vs. Line Voltage and Load Current @ 25°C

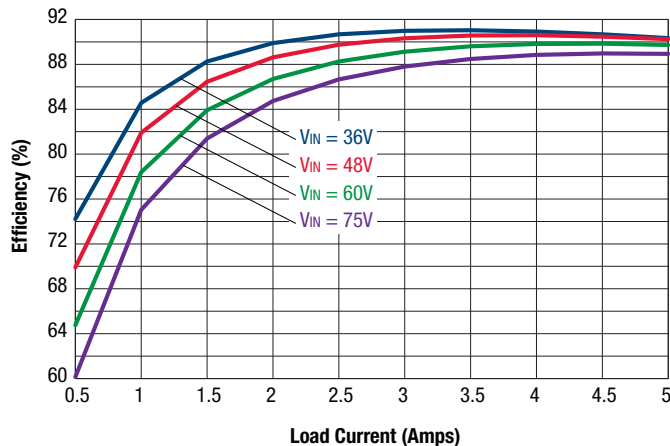

Maximum Current Temperature Derating at sea level
Vin = 36 (air flow from J1 to J2 on PCB)

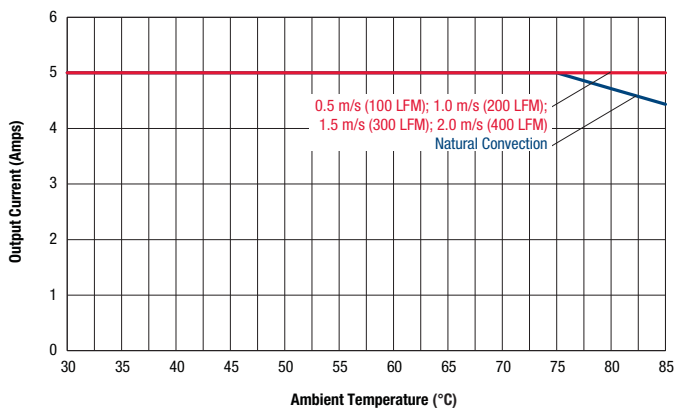

Maximum Current Temperature Derating at sea level
Vin = 48 (air flow from J1 to J2 on PCB)

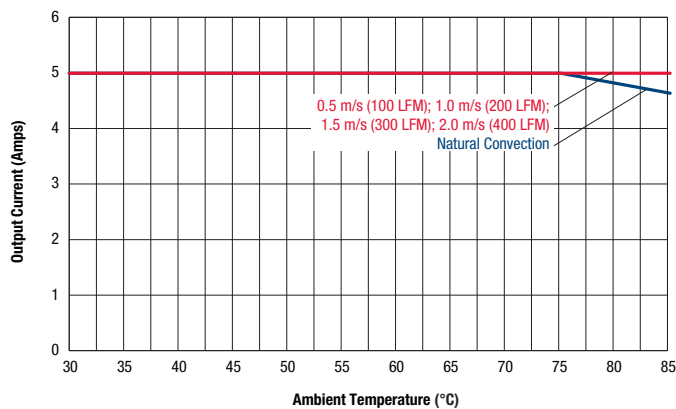

Maximum Current Temperature Derating at sea level
Vin = 60 (air flow from J1 to J2 on PCB)

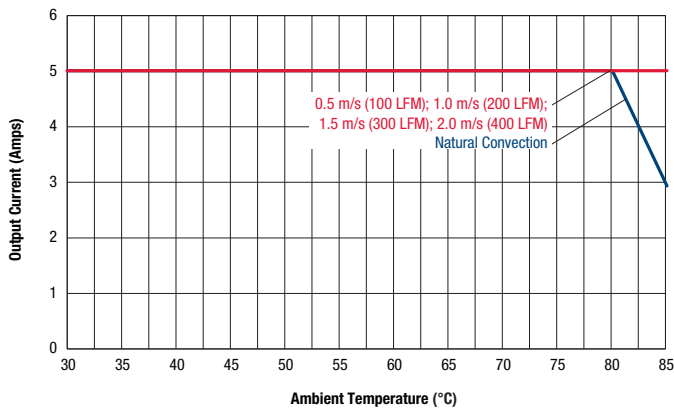

Maximum Current Temperature Derating at sea level
Vin = 75 (air flow from J1 to J2 on PCB)

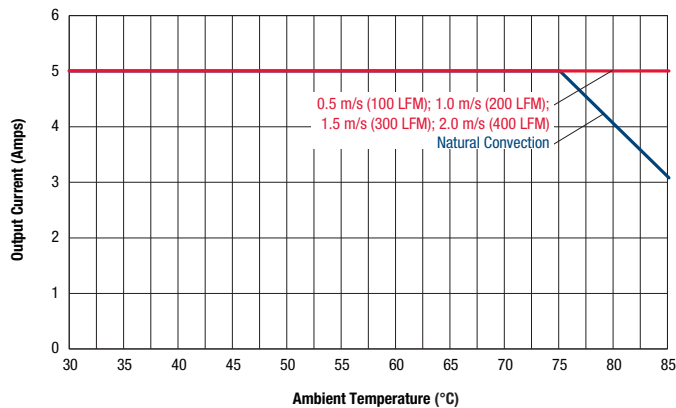

TYPICAL PERFORMANCE DATA, SPM25-050-D48

Start-up Delay (Vin = 48V, Iout = 5A, Ta = +25°C) Ch1 = Vin, Ch4 = Vout

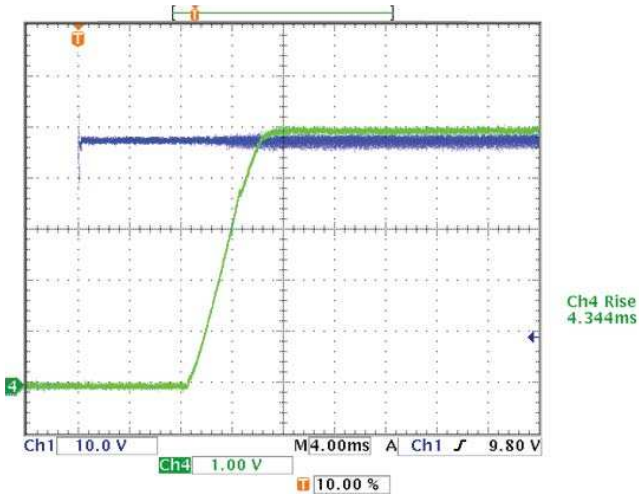

Enable Start-up Delay (Vin = 48V, Iout = 5A, Ta = +25°C) Ch1 = Enable, Ch4 = Vout

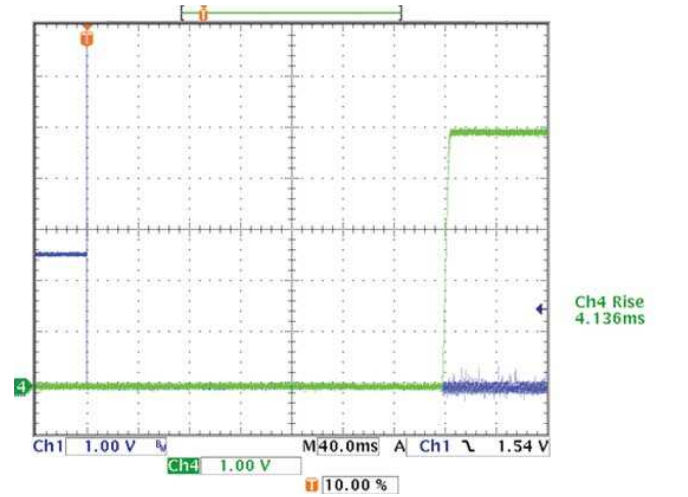

Output Ripple and Noise (Vin = 48V, Io = 5A, Load = 1μF || 10μF, Ta = +25°C)

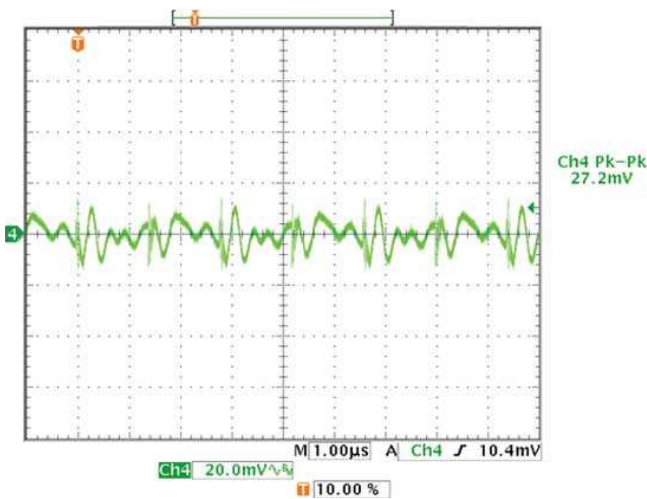

Step Load Transient Response (Vin = 48V, Vout = nom, Iout = 100 to 50% of full load 1μF || 10μF)

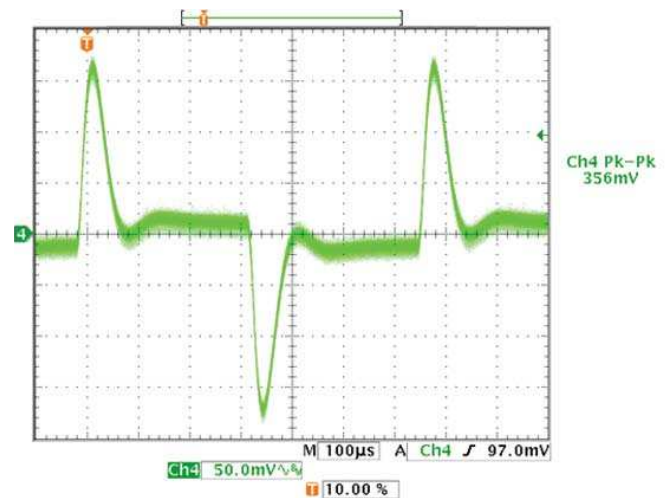

FUNCTIONAL SPECIFICATIONS – MODEL SPM25-120-D48

ABSOLUTE MAXIMUM RATINGS	Conditions ①	Minimum	Typical/Nominal	Maximum	Units
Input Voltage, Continuous		0		80	Vdc
Input Voltage, Transient	100 mS max. duration			100	Vdc
Isolation Voltage	Input to output, continuous			1600	Vdc
On/Off Remote Control	Power on, referred to -Vin	0		15	Vdc
Output Power		0		25.45	W
Output Current	Current-limited, no damage, short-circuit protected	0		5	A
Storage Temperature Range	Vin = Zero (no power)	-55		125	°C
Absolute maximums are stress ratings. Exposure of devices to greater than any of these conditions may adversely affect long-term reliability. Proper operation under conditions other than those listed in the Performance/Functional Specifications Table is not implied or recommended.					
INPUT					
Operating voltage range		36	48	75	Vdc
Recommended External Fuse	Fast blow			1.5	A
Start-up threshold	Rising input voltage	32.8	34	35	Vdc
Undervoltage shutdown	Falling input voltage	32	33.5	35	Vdc
Turn-On/Turn-Off Hysteresis			1.5		Vdc
Internal Filter Type			C		
Input current					
Full Load Input Current	Vin = nominal		0.603	0.624	A
Low Line Input Current	Vin = minimum		0.809	0.842	A
Inrush Transient			0.05		A ² -Sec.
Short Circuit Input Current			50	100	mA
No Load Input Current	Iout = minimum, unit=ON		20	35	mA
Shut-Down Input Current (Off, UV, OT)			1	2	mA
Reflected (back) ripple current ②	Measured at input with specified filter		30		mA, p-p
Pre-biased startup	External output voltage < Vset		Monotonic		
GENERAL and SAFETY					
Efficiency	Vin = 48V, full load	85	87		%
	Vin = min., full load		86.5		%
Isolation					
Isolation Voltage	Input to output, continuous	1600			Vdc
Insulation Safety Rating			basic		
Isolation Resistance			10		MΩ
Isolation Capacitance			1700		pF
Safety	Certified to UL-60950-1, CSA-C22.2 No. 60950-1, IEC60950-1, 2nd edition, with AM1		Yes		
Calculated MTBF	Per Telcordia SR332, issue 1, class 3, ground fixed, Tambient = +25°C		TBD		Hours x 10 ⁶
DYNAMIC CHARACTERISTICS					
Fixed Switching Frequency		295	325	355	KHz
Startup Time	Power on to Vout regulated		10	50	mS
Startup Time	Remote ON to Vout regulated		10	50	mS
Dynamic Load Response	50-75-50% load step, settling time to within 1% of Vout		100	150	μSec
Dynamic Load Peak Deviation	same as above		±250	±350	mV
FEATURES and OPTIONS					
Remote On/Off Control ③					
"N" suffix					
Negative Logic, ON state	ON = Ground pin or external voltage	-0.7		0.8	V
Negative Logic, OFF state	OFF = Pin open or external voltage	10		15	V
Control Current	Open collector/drain		1		mA
"P" suffix					
Positive Logic, ON state	ON = Pin open or external voltage	10		15	V
Positive Logic, OFF state	OFF = Ground pin or external voltage	-0.7		0.7	V
Control Current	Open collector/drain		1		mA

FUNCTIONAL SPECIFICATIONS (CONT.) – MODEL SPM25-120-D48

OUTPUT	Conditions ① ③	Minimum	Typical/Nominal	Maximum	Units
Total Output Power	See Derating	0.0	25.2	25.45	W
Voltage					
Nominal Output Voltage	No trim	11.88	12	12.12	Vdc
Setting Accuracy	At 50% load, no trim	-1		1	% of Vset
Output Voltage Range	User-adjustable	-10		10	% of Vnom
Overvoltage Protection	Via magnetic feedback	14	19	22	Vdc
Current					
Output Current Range		0	2.1	2.1	A
Minimum Load			No minimum load		% of Iout
Current Limit Inception	98% of Vnom., after warmup	2.3	3	3.4	A
Short Circuit					
Short Circuit Current	Hiccup technique, autorecovery within ±1.25% of Vout			0.1	A
Short Circuit Duration (remove short for recovery)	Output shorted to ground, no damage		Continuous		
Short circuit protection method	Current limiting				
Regulation					
Line Regulation	Vin = min. to max., Vout = nom., Iout = nom.			±0.1	% of Vout
Load Regulation	Iout = min. to max., Vin = 48V			±0.125	% of Vout
Ripple and Noise	5 Hz - 20 MHz BW		65	120	mV pk-pk
Temperature Coefficient	At all outputs		±0.02		% of Vnom./°C
Maximum Capacitive Loading	Low ESR, resistive load only			470	µF
MECHANICAL					
Outline Dimensions			1" x 1" x 0.41"		Inches
(Please refer to outline drawing)	WxLxH		25.4 x 25.4 x 10.41 mm		mm
Weight			0.69		Ounces
			19.56		Grams
Through Hole Pin Diameter			0.04		Inches
			1.016		mm
Through Hole Pin Material			Copper alloy		
TH Pin Plating Metal and Thickness	Nickel subplate		50		µ-inches
	Gold overplate		5		µ-inches
ENVIRONMENTAL					
Operating Ambient Temperature Range	See derating	-40		85	°C
Operating Case Temperature Range	No derating	-40		105	°C
Case Material	Tin plated steel with black powder coat				
Storage Temperature	Vin = Zero (no power)	-55		125	°C
Thermal Protection/Shutdown	Measured in center	110	115	120	°C
Electromagnetic Interference	External filter is required				
Conducted, EN55022/CISPR22			B		Class
Radiated, EN55022/CISPR22			B		Class
RoHS rating			RoHS-6		

Notes

- ① Unless otherwise noted, all specifications are at nominal input voltage, nominal output voltage and full load. General conditions are +25° Celsius ambient temperature, near sea level altitude, natural convection airflow. All models are tested and specified with external parallel 1 µF and 10 µF output capacitors. The external input capacitor is 4.7 µF. All capacitors are low-ESR types wired close to the converter.
- ② Input (back) ripple current is tested and specified over 5 Hz to 20 MHz bandwidth. Input filtering is Cbus=220 µF, Cin=33 µF and Lbus=12 µH.
- ③ The Remote On/Off Control is referred to -Vin.

TYPICAL PERFORMANCE DATA, SPM25-120-D48

Efficiency vs. Line Voltage and Load Current @ 25°C

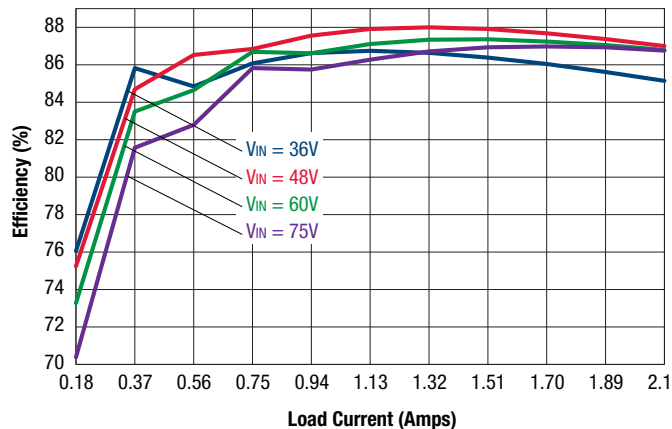

Power Dissipation

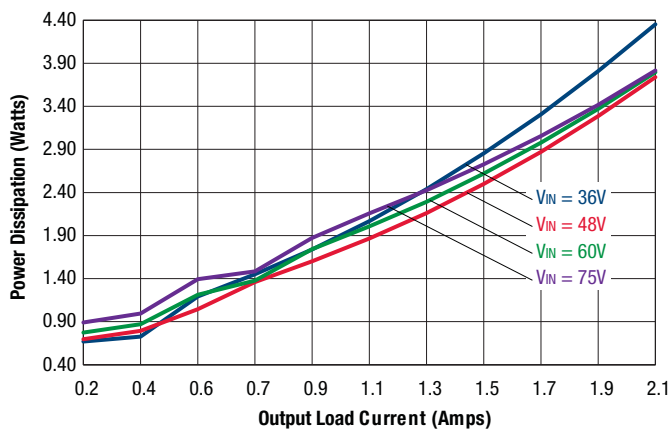

Maximum Current Temperature Derating at sea level
Vin = 36 (air flow from J1 to J2 on PCB)

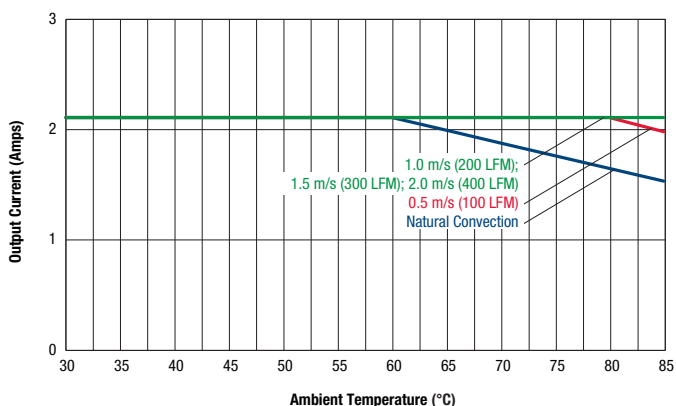

Maximum Current Temperature Derating at sea level
Vin = 48 (air flow from J1 to J2 on PCB)

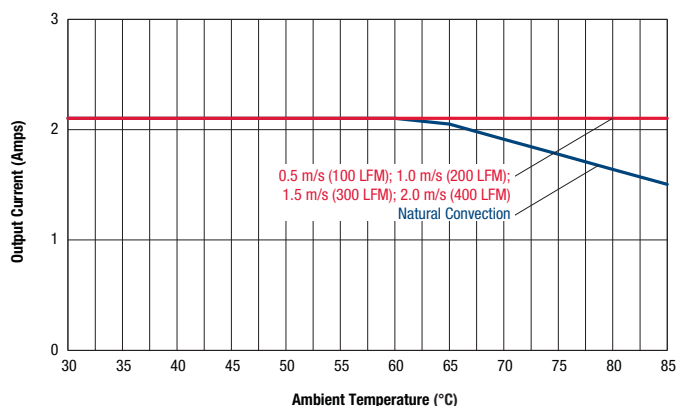

Maximum Current Temperature Derating at sea level
Vin = 60 (air flow from J1 to J2 on PCB)

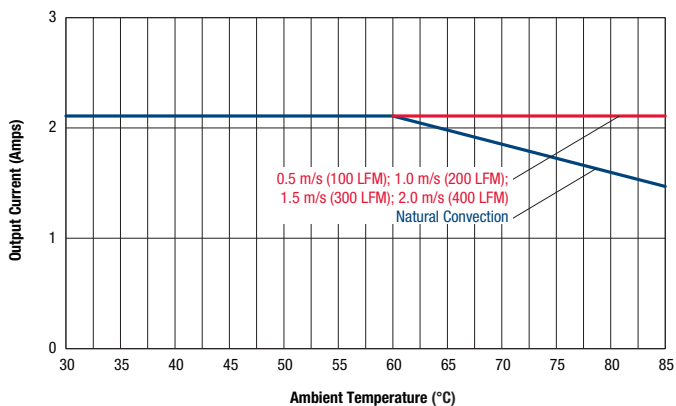

Maximum Current Temperature Derating at sea level
Vin = 75 (air flow from J1 to J2 on PCB)

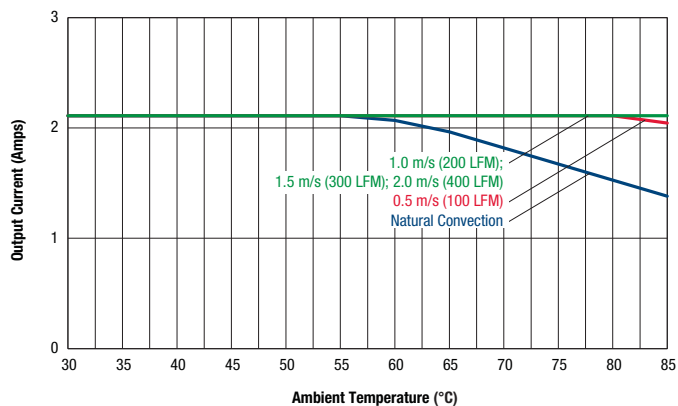

TYPICAL PERFORMANCE DATA, SPM25-120-D48

Start-up Delay (Vin = 48V, Iout = 2.1A, Ta = +25°C) Ch1 = Vin, Ch4 = Vout

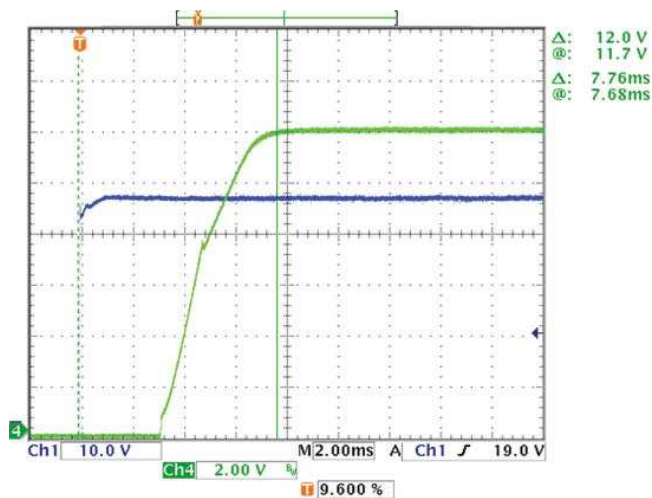

Enable Start-up Delay (Vin = 48V, Iout = 2.1A, Ta = +25°C) Ch1 = Enable, Ch4 = Vout

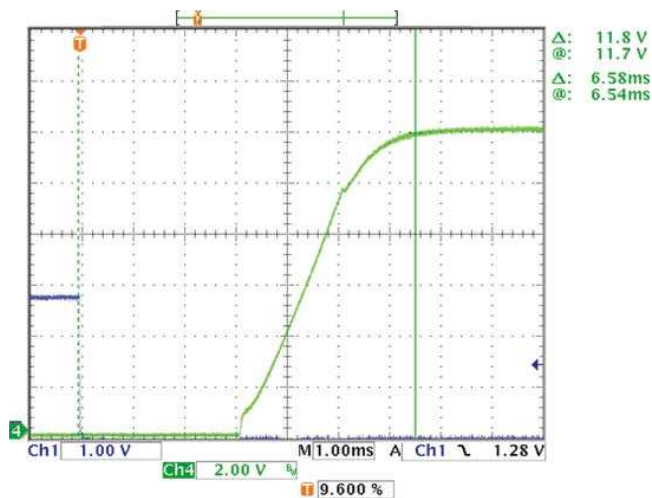

Output Ripple and Noise (Vin = 48V, I_o = 2.1A, Cload = 1μF || 10μF, Ta = +25°C)

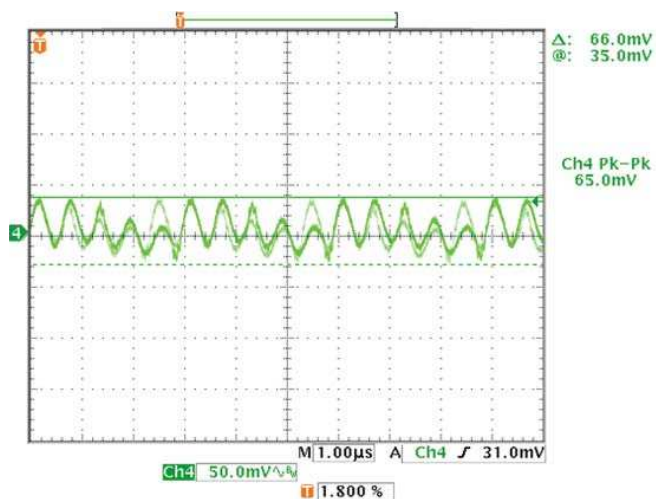

Step Load Transient Response (Vin = 48V, Vout = nom, Iout = 100 to 50% of full load 1μF || 10μF)

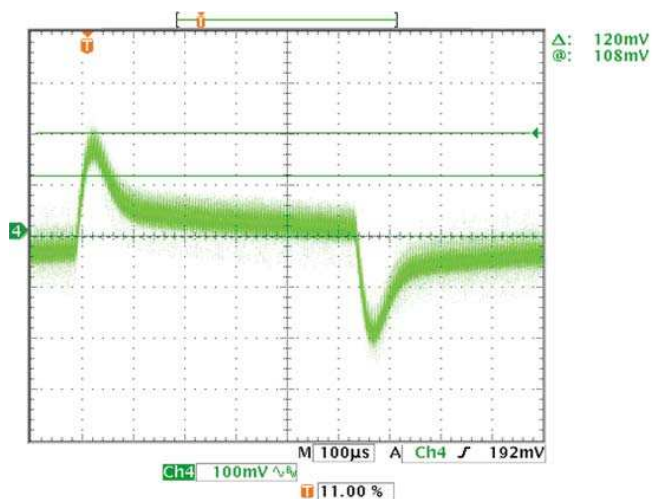

MECHANICAL SPECIFICATIONS

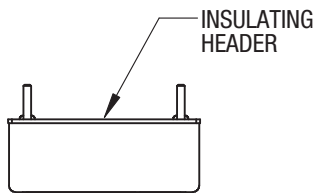
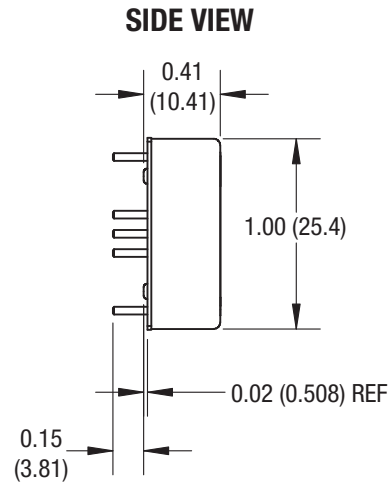
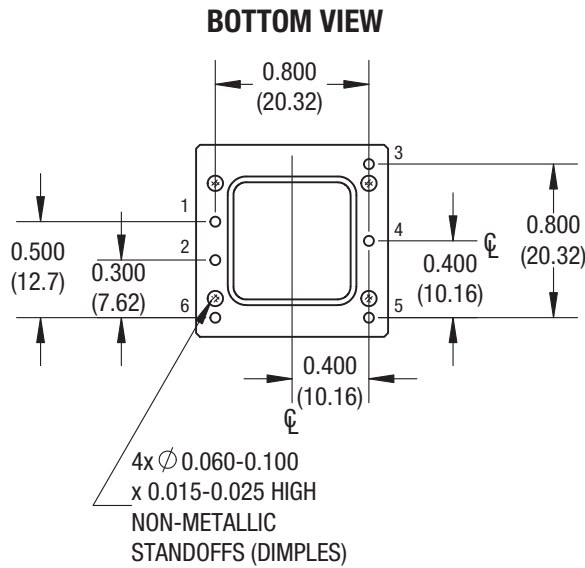

END VIEW

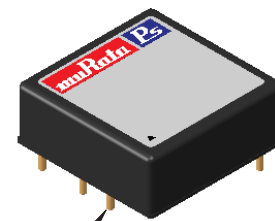

PIN #1

**ISOMETRIC VIEW
(FOR REF ONLY)**

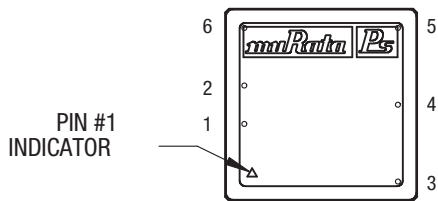

TOP VIEW

MATERIAL:
Ø .040 PINS: COPPER ALLOY

FINISH: (ALL PINS)
GOLD (5µ"MIN) OVER NICKEL (50µ" MIN)

INPUT/OUTPUT CONNECTIONS	
Pin	SPM Function (Single Output)
1	+Vin
2	-Vin
3	+Vout
4	Output Trim*
5	-Vout
6	On/Off Control*

The Remote On/Off can be provided with either positive (P suffix) or negative (N suffix) logic. See part number structure for options.

Dimensions are in inches (mm shown for ref. only).

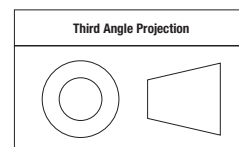

Tolerances (unless otherwise specified):
.XX ± 0.02 (0.5)
.XXX ± 0.010 (0.25)
Angles ± 1°

Components are shown for reference only.

RECOMMENDED FOOTPRINT (VIEW THROUGH CONVERTER)

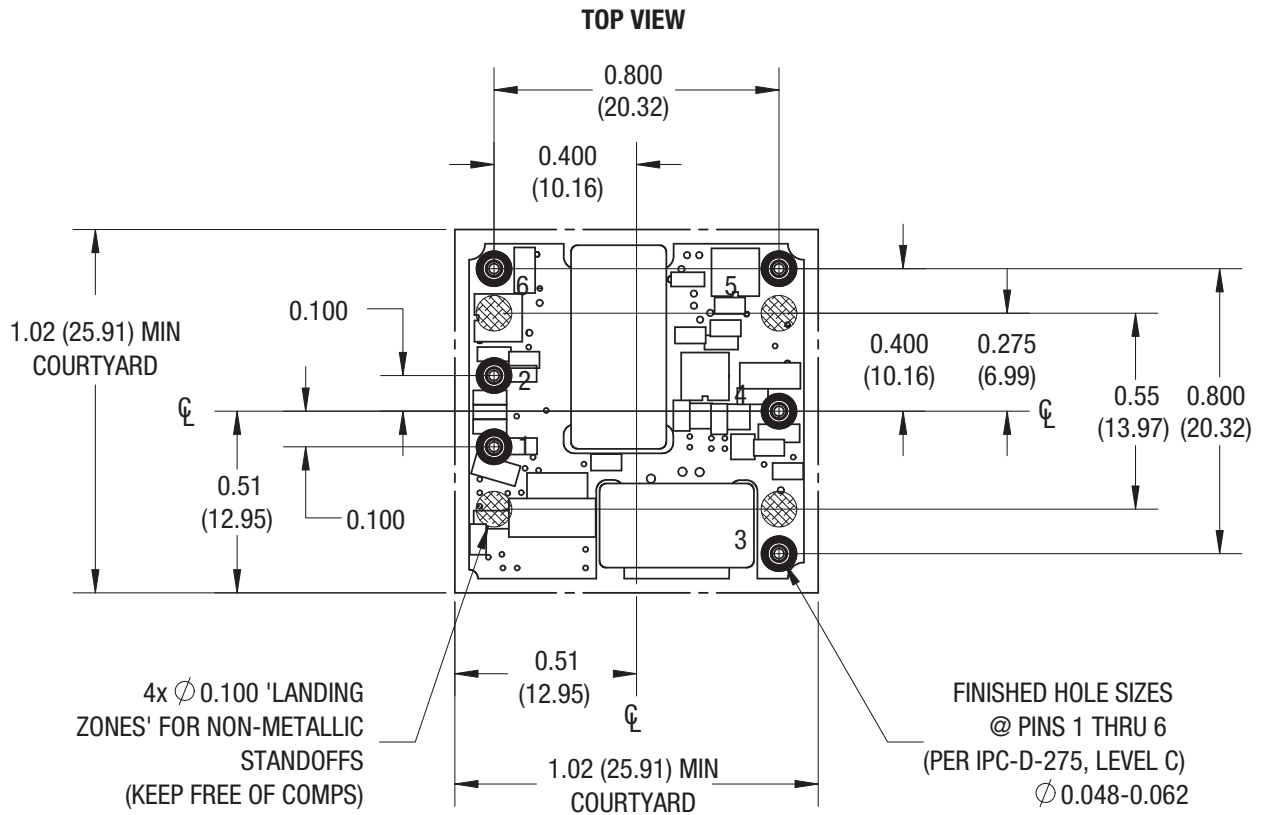

STANDARD PACKAGING

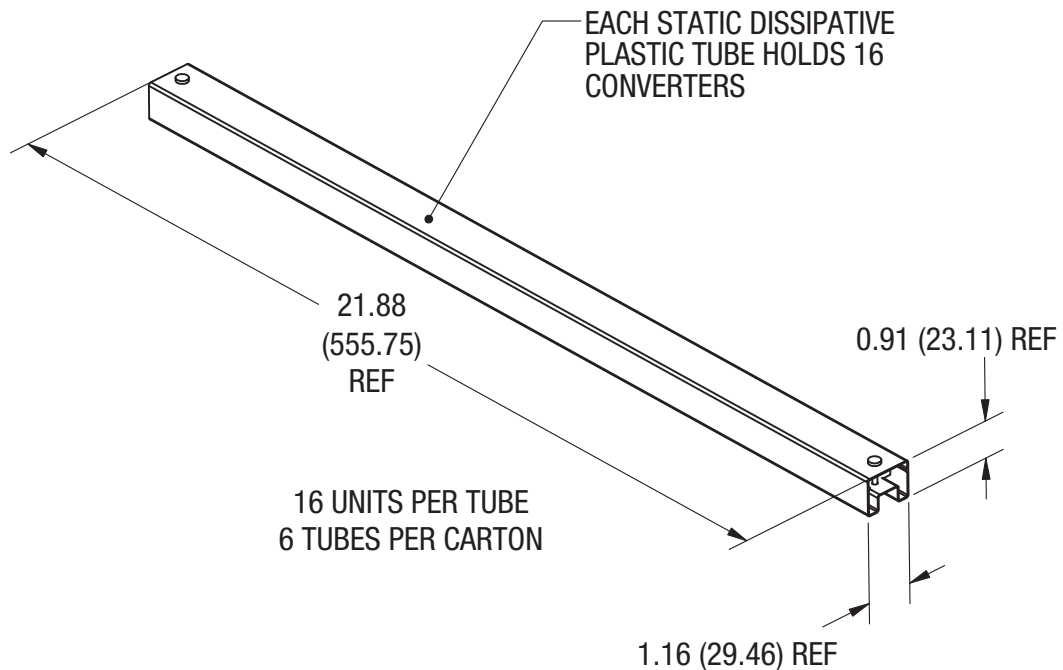

TECHNICAL NOTES

Input Fusing

Certain applications and/or safety agencies may require fuses at the inputs of power conversion components. Fuses should also be used when there is the possibility of sustained input voltage reversal which is not current-limited. For greatest safety, we recommend a fast blow fuse installed in the ungrounded input supply line.

The installer must observe all relevant safety standards and regulations. For safety agency approvals, install the converter in compliance with the end-user safety standard.

Input Under-Voltage Shutdown and Start-Up Threshold

Under normal start-up conditions, converters will not begin to regulate properly until the rising input voltage exceeds and remains at the Start-Up Threshold Voltage (see Specifications). Once operating, converters will not turn off until the input voltage drops below the Under-Voltage Shutdown Limit. Subsequent restart will not occur until the input voltage rises again above the Start-Up Threshold. This built-in hysteresis prevents any unstable on/off operation at a single input voltage.

Users should be aware however of input sources near the Under-Voltage Shutdown whose voltage decays as input current is consumed (such as capacitor inputs), the converter shuts off and then restarts as the external capacitor re-charges. Such situations could oscillate. To prevent this, make sure the operating input voltage is well above the UV Shutdown voltage AT ALL TIMES.

Start-Up Delay

Assuming that the output current is set at the rated maximum, the V_{in} to V_{out} Start-Up Delay (see Specifications) is the time interval between the point when the rising input voltage crosses the Start-Up Threshold and the fully loaded regulated output voltage enters and remains within its specified regulation band. Actual measured times will vary with input source impedance, external input capacitance, input voltage slew rate and final value of the input voltage as it appears at the converter.

These converters include a soft start circuit to moderate the duty cycle of the PWM controller at power up, thereby limiting the input inrush current.

The On/Off Remote Control interval from inception to V_{out} regulated assumes that the converter already has its input voltage stabilized above the Start-Up Threshold before the On command. The interval is measured from the On command until the output enters and remains within its specified regulation band. The specification assumes that the output is fully loaded at maximum rated current.

Input Source Impedance

These converters will operate to specifications without external components, assuming that the source voltage has very low impedance and reasonable input voltage regulation. Since real-world voltage sources have finite impedance, performance is improved by adding external filter components. Sometimes only a small ceramic capacitor is sufficient. Since it is difficult to totally characterize all applications, some experimentation may be needed. Note that external input capacitors must accept high speed switching currents.

Because of the switching nature of DC/DC converters, the input of these converters must be driven from a source with both low AC impedance and adequate DC input regulation. Performance will degrade with increasing input inductance. Excessive input inductance may inhibit operation. The DC input regulation specifies that the input voltage, once operating, must never degrade below the Shut-Down Threshold under all load conditions. Be sure to use adequate trace sizes and mount components close to the converter.

I/O Filtering, Input Ripple Current and Output Noise

All models in this converter series are tested and specified for input reflected ripple current and output noise using designated external input/output components, circuits and layout as shown in the figures below. External input capacitors (C_{in} in the figure) serve primarily as energy storage elements, minimizing line voltage variations caused by transient IR drops in the input conductors. Users should select input capacitors for bulk capacitance (at appropriate frequencies), low ESR and high RMS ripple current ratings. In the figure below, the C_{BUS} and L_{BUS} components simulate a typical DC voltage bus. Your specific system configuration may require additional considerations. Please note that the values of C_{in} , L_{BUS} and C_{BUS} may vary according to the specific converter model.

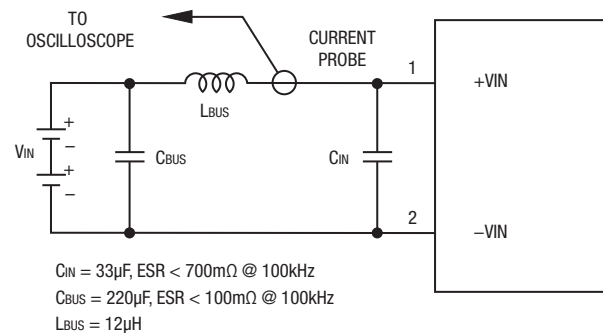

Figure 2. Measuring Input Ripple Current

In critical applications, output ripple and noise (also referred to as periodic and random deviations or PARD) may be reduced by adding filter elements such as multiple external capacitors. Be sure to calculate component temperature rise from reflected AC current dissipated inside capacitor ESR.

Floating Outputs

Since these are isolated DC/DC converters, their outputs are “floating” with respect to their input. The essential feature of such isolation is ideal ZERO CURRENT FLOW between input and output. Real-world converters however do exhibit tiny leakage currents between input and output (see Specifications). These leakages consist of both an AC stray capacitance coupling component and a DC leakage resistance. When using the isolation feature, do not allow the isolation voltage to exceed specifications. Otherwise the converter may be damaged. Designers will normally use the negative output (-Output) as the ground return of the load circuit. You can however use the positive output (+Output) as the ground return to effectively reverse the output polarity.

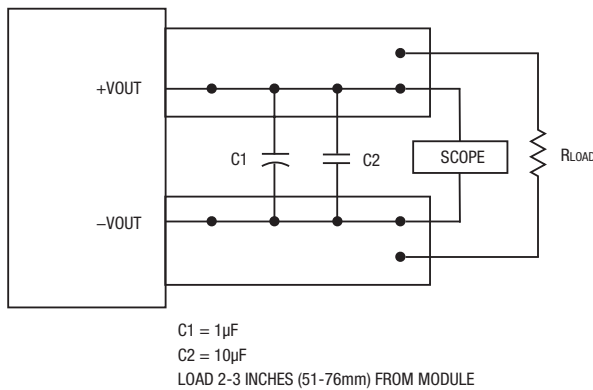

Figure 3. Measuring Output Ripple and Noise (PARD)

Minimum Output Loading Requirements

These converters employ a synchronous rectifier design topology. All models regulate within specification and are stable from 0% load to full load conditions, unless otherwise specified. Operation under no load will not damage the converter but might, however, slightly increase regulation, output ripple, and noise.

Thermal Shutdown

To protect against thermal over-stress, these converters include thermal shutdown circuitry. If environmental conditions cause the temperature of the DC/DC's to rise above the Operating Temperature Range up to the shutdown temperature, an on-board electronic temperature sensor will power down the unit. When the temperature decreases below the turn-on threshold, the converter will automatically restart. There is a small amount of hysteresis to prevent rapid on/off cycling. CAUTION: If you operate too close to the thermal limits, the converter may shut down suddenly without warning. Be sure to thoroughly test your application to avoid unplanned thermal shutdown.

Temperature Derating Curves

The graphs in the performance data section illustrate typical operation under a variety of conditions. The Derating curves show the maximum continuous ambient air temperature and decreasing maximum output current which is acceptable under increasing forced airflow measured in Linear Feet per Minute (“LFM”). Note that these are AVERAGE measurements. The converter will accept brief increases in temperature and/or current or reduced airflow as long as the average is not exceeded.

Note that the temperatures are of the ambient airflow, not the converter itself which is obviously running at higher temperature than the outside air. Also note that “natural convection” is defined as very low flow rates which are not using fan-forced airflow. Depending on the application, “natural convection” is usually about 30-65 LFM but is not equal to still air (0 LFM).

Murata Power Solutions makes Characterization measurements in a closed cycle wind tunnel with calibrated airflow. We use both thermocouples and an infrared camera system to observe thermal performance. As a practical matter, it is quite difficult to insert an anemometer to precisely measure airflow in

most applications. Sometimes it is possible to estimate the effective airflow if you thoroughly understand the enclosure geometry, entry/exit orifice areas and the fan flowrate specifications.

CAUTION: If you exceed these Derating guidelines, the converter may have an unplanned Over Temperature shut down. Also, these graphs are all collected near Sea Level altitude. Be sure to reduce the derating for higher altitude.

Output Overvoltage Protection (OVP)

This converter monitors its output voltage for an over-voltage condition using an on-board electronic comparator. The signal is optically coupled to the primary side PWM controller. If the output exceeds OVP limits, the sensing circuit will power down the unit, and the output voltage will decrease. After a time-out period, the PWM will automatically attempt to restart, causing the output voltage to ramp up to its rated value. It is not necessary to power down and reset the converter for this automatic OVP-recovery restart.

If the fault condition persists and the output voltage climbs to excessive levels, the OVP circuitry will initiate another shutdown cycle. This on/off cycling is referred to as “hiccup” mode.

Output Current Limiting

As soon as the output current increases to approximately its overcurrent limit, the DC/DC converter will enter a current-limiting mode. The output voltage will decrease proportionally with increases in output current, thereby maintaining a somewhat constant power output. This is commonly referred to as power limiting.

Current limiting inception is defined as the point at which full power falls below the rated tolerance. See the Performance/Functional Specifications. Note particularly that the output current may briefly rise above its rated value. This enhances reliability and continued operation of your application. If the output current is too high, the converter will enter the short circuit condition.

Output Short Circuit Condition

When a converter is in current-limit mode, the output voltage will drop as the output current demand increases. If the output voltage drops too low, the magnetically coupled voltage used to develop PWM bias voltage will also drop, thereby shutting down the PWM controller. Following a time-out period, the PWM will restart, causing the output voltage to begin rising to its appropriate value. If the short-circuit condition persists, another shutdown cycle will initiate. This on/off cycling is called “hiccup mode.” The hiccup cycling reduces the average output current, thereby preventing excessive internal temperatures.

Trimming the Output Voltage

The Trim input to the converter allows the user to adjust the output voltage over the rated trim range (please refer to the Specifications). In the trim equations and circuit diagrams that follow, trim adjustments use a single fixed resistor connected between the Trim input and either Vout pin. Trimming resistors should have a low temperature coefficient (± 100 ppm/°C or less) and be mounted close to the converter. Keep leads short. If the trim function is not used, leave the trim unconnected. With no trim, the converter will exhibit its specified output voltage accuracy.

There are two CAUTIONs to observe for the Trim input:

CAUTION: To avoid unplanned power down cycles, do not exceed EITHER the maximum output voltage OR the maximum output power when setting the trim. If the output voltage is excessive, the OVP circuit may inadvertently shut down the converter. If the maximum power is exceeded, the converter may enter current limiting. If the power is exceeded for an extended period, the converter may overheat and encounter overtemperature shut down.

CAUTION: Be careful of external electrical noise. The Trim input is a sensitive input to the converter's feedback control loop. Excessive electrical noise may cause instability or oscillation. Keep external connections short to the Trim input. Use shielding if needed.

Trim Equations

Trim Up	Trim Down
SPM25-033-D48	
$R_{TUP} (\Omega) = \frac{12775}{V_o - 3.3} - 2050$	$R_{TDOWN} (\Omega) = \frac{5110 \times (V_o - 2.5)}{3.3 - V_o} - 2050$
SPM25-050-D48	
$R_{TUP} (\Omega) = \frac{12775}{V_o - 5} - 2050$	$R_{TDOWN} (\Omega) = \frac{5110 \times (V_o - 2.5)}{5 - V_o} - 2050$
SPM25-120-D48	
$R_{TUP} (\Omega) = \frac{25000}{V_o - 12} - 5110$	$R_{TDOWN} (\Omega) = \frac{10000 (V_o - 2.5)}{12 - V_o} - 5110$

<Connect trim resistor between Trim and -Vout>

<Connect trim resistor between Trim and +Vout>

Where V_o = Desired output voltage. Adjustment accuracy is subject to resistor tolerances and factory-adjusted output accuracy. Mount trim resistor close to converter. Use short leads.

Remote On/Off Control

On the input side, a remote On/Off Control can be specified with either positive or negative logic as follows:

Positive: Models equipped with Positive Logic are enabled when the On/Off pin is left open or is pulled high to +15V_{DC} with respect to -V_{IN}. An internal bias current causes the open pin to rise to +V_{IN}. Positive-logic devices are disabled when the On/Off is grounded or brought to within a low voltage (see Specifications) with respect to -V_{IN}.

Negative: Models with negative logic are on (enabled) when the On/Off is grounded or brought to within a low voltage (see Specifications) with respect to -V_{IN}. The device is off (disabled) when the On/Off is left open or is pulled high to +15V_{DC} Max. with respect to -V_{IN}.

Dynamic control of the On/Off function should be able to sink the specified signal current when brought low and withstand specified voltage when brought high. Be aware too that there is a finite time in milliseconds (see Specifications) between the time of On/Off Control activation and stable, regulated output. This time will vary slightly with output load type and current and input conditions.

There are two CAUTIONs for the On/Off Control:

CAUTION: While it is possible to control the On/Off with external logic if you carefully observe the voltage levels, the preferred circuit is either an open drain/open collector transistor or a relay (which can thereupon be controlled by logic). The On/Off prefers to be set at approx. +15V (open pin) for the ON state, assuming positive logic.

CAUTION: Do not apply voltages to the On/Off pin when there is no input power voltage. Otherwise the converter may be permanently damaged.

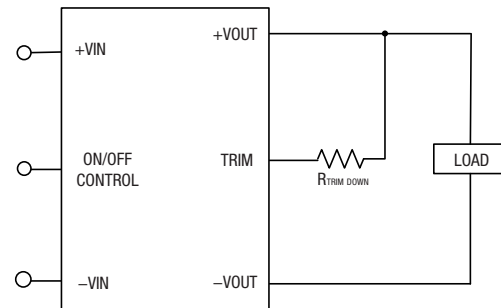

Figure 4. Trim adjustments to decrease Output Voltage using a Fixed Resistor

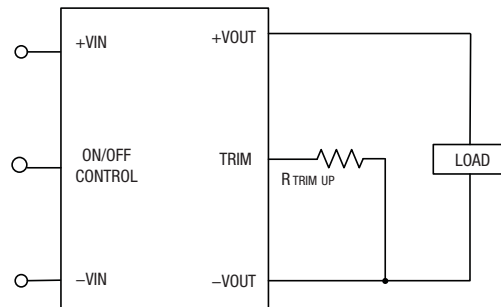

Figure 5. Trim adjustments to increase Output Voltage using a Fixed Resistor

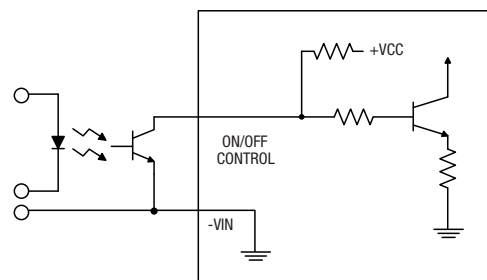

Figure 6. Driving the On/Off Control Pin (suggested circuit)

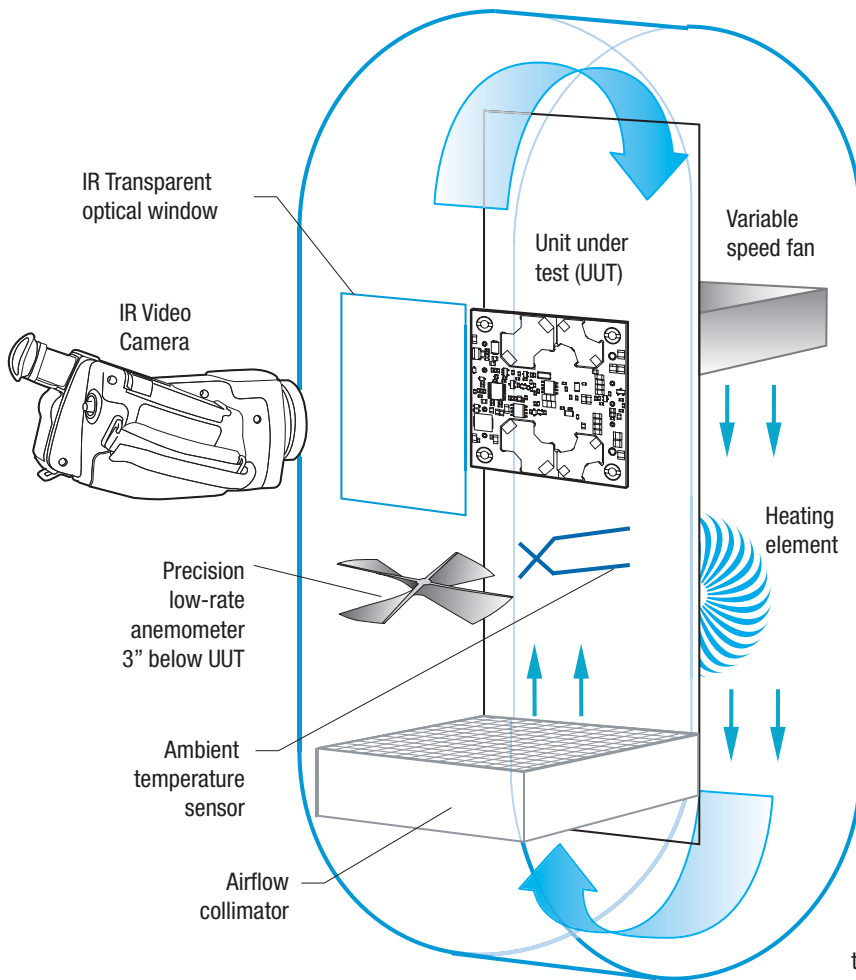

Figure 7. Vertical Wind Tunnel

Vertical Wind Tunnel

Murata Power Solutions employs a computer controlled custom-designed closed loop vertical wind tunnel, infrared video camera system, and test instrumentation for accurate airflow and heat dissipation analysis of power products. The system includes a precision low flow-rate anemometer, variable speed fan, power supply input and load controls, temperature gauges, and adjustable heating element.

The IR camera monitors the thermal performance of the Unit Under Test (UUT) under static steady-state conditions. A special optical port is used which is transparent to infrared wavelengths.

Both through-hole and surface mount converters are soldered down to a 10" X10" host carrier board for realistic heat absorption and spreading. Both longitudinal and transverse airflow studies are possible by rotation of this carrier board since there are often significant differences in the heat dissipation in the two airflow directions. The combination of adjustable airflow, adjustable ambient heat, and adjustable Input/Output currents and voltages mean that a very wide range of measurement conditions can be studied.

The collimator reduces the amount of turbulence adjacent to the UUT by minimizing airflow turbulence. Such turbulence influences the effective heat transfer characteristics and gives false readings. Excess turbulence removes more heat from some surfaces and less heat from others, possibly causing uneven overheating.

Both sides of the UUT are studied since there are different thermal gradients on each side. The adjustable heating element and fan, built-in temperature gauges, and no-contact IR camera mean that power supplies are tested in real-world conditions.

Soldering Guidelines

Murata Power Solutions recommends the specifications below when installing these converters. These specifications vary depending on the solder type. Exceeding these specifications may cause damage to the product. Be cautious when there is high atmospheric humidity. We strongly recommend a mild pre-bake (100° C. for 30 minutes). Your production environment may differ; therefore please thoroughly review these guidelines with your process engineers.

Wave Solder Operations for through-hole mounted products (THMT)			
For Sn/Ag/Cu based solders:		For Sn/Pb based solders:	
Maximum Preheat Temperature	115° C.	Maximum Preheat Temperature	105° C.
Maximum Pot Temperature	270° C.	Maximum Pot Temperature	250° C.
Maximum Solder Dwell Time	7 seconds	Maximum Solder Dwell Time	6 seconds

Murata Power Solutions, Inc.
11 Cabot Boulevard, Mansfield, MA 02048-1151 U.S.A.
ISO 9001 and 14001 REGISTERED



This product is subject to the following operating requirements and the Life and Safety Critical Application Sales Policy:
Refer to: <http://www.murata-ps.com/requirements/>

Murata Power Solutions, Inc. makes no representation that the use of its products in the circuits described herein, or the use of other technical information contained herein, will not infringe upon existing or future patent rights. The descriptions contained herein do not imply the granting of licenses to make, use, or sell equipment constructed in accordance therewith. Specifications are subject to change without notice. © 2013 Murata Power Solutions, Inc.