

ETM70CP201 Datasheet

Technical Specifications

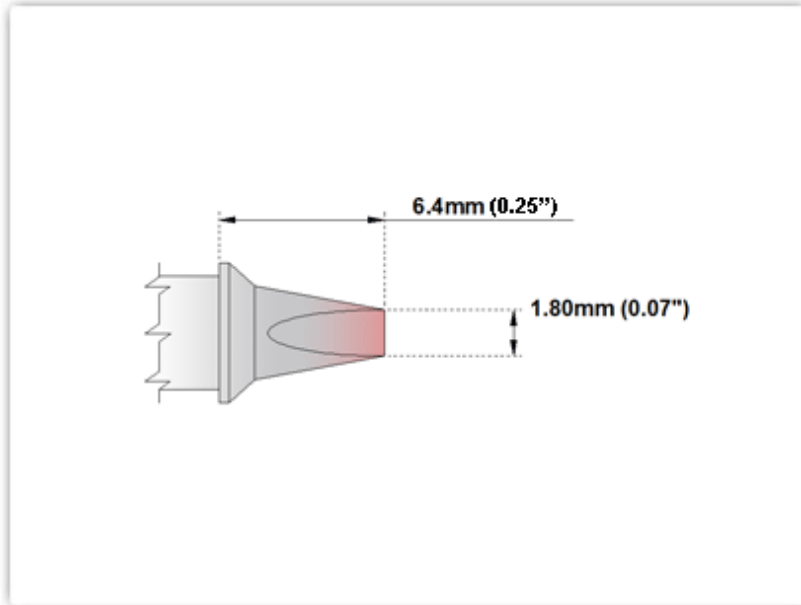

ETM70CP201

Chisel 30° 1.80mm (0.07")

Tip Style: Chisel 30°

Tip Width: 1.80mm (0.07")

Tip Length: 6.40mm (0.25")

70 Type Cartridge¹:

350°C - 398°C

RoHS Compliant² / Lead Free:

YES

For Use With:

EB-5000S-1, EB-5000S-2

Material Composition



**All components
are RoHS
compliant and
Lead-Free.**

¹ Easy Braid Co. tip cartridges will typically idle within a temperature range of +/-1.1°C. However, there is variation in idle temperature across tip geometries within an individual temperature series. Easy Braid Co. offers a wide variety of tip geometries from 0.25mm fine point tip to 5mm chisel. The length and geometry of a tip will have an influence on the tip idle temperature. To accurately measure idle temperature it will depend greatly on the measurement method, technique and equipment used. Two different methods or the use of alternative equipment will produce different test results.

² Please refer to <http://www.rohs.gov.uk> for details on RoHS Compliance.