

SURFACE MOUNT SUPER FAST RECTIFIER

VOLTAGE RANGE 50 to 200 Volts CURRENT 1.0 Ampere

FEATURES

- * High reliability
- * Low leakage
- * Low forward voltage
- * High current capability
- * Super fast switching speed
- * High surge capability
- * Good for switching mode circuit

MECHANICAL DATA

- * Case: Molded plastic
- * Epoxy: Device has UL flammability classification 94V-0
- * Lead: MIL-STD-202E method 208C guaranteed
- * Mounting position: Any
- * Weight: 0.016 gram

MAXIMUM RATINGS AND ELECTRICAL CHARACTERISTICS

Ratings at 25 °C ambient temperature unless otherwise specified.
Single phase, half wave, 60 Hz, resistive or inductive load.
For capacitive load, derate current by 20%.



SOD-123FL

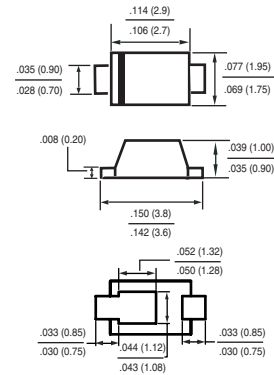

Dimensions in inches and (millimeters)

MAXIMUM RATINGS (At TA = 25°C unless otherwise noted)

RATINGS		SYMBOL	SE1L	SE2L	SE3L	SE4L	UNITS
Maximum Recurrent Peak Reverse Voltage		VRRM	50	100	150	200	Volts
Maximum RMS Volts		VRMS	35	70	105	140	Volts
Maximum DC Blocking Voltage		VDC	50	100	150	200	Volts
Maximum Average Forward Current at TA = 55°C		Io	1.0				Amps
Peak Forward Surge Current IFM (surge):8.3 ms single half sine-wave superimposed on rated load (JEDEC method)		IFSM	25				Amps
Typical Junction Capacitance (Note 2)		Cj	20				pF
Operating and Storage Temperature Range		TJ, TSTG	-55 to +150				°C

ELECTRICAL CHARACTERISTICS (At TA = 25°C unless otherwise noted)

CHARACTERISTICS		SYMBOL	SE1L	SE2L	SE3L	SE4L	UNITS
Maximum Forward Voltage at 1.0 A DC		VF	0.95				Volts
Maximum DC Reverse Current at Rated DC Blocking Voltage	@ TA = 25°C	IR	5.0				uAmps
	@ TA = 100°C		100				
Maximum Reverse Recovery Time (Note 1)		trr	35				nSec

- NOTES : 1. Test Conditions: IF=0.5A, IR=-1.0A, IRR=-0.25A.
2. Measured at 1 MHz and applied reverse voltage of 4.0 volts.
3."Fully ROHS compliant", "100% Sn plating (Pb-free)".

RATING AND CHARACTERISTIC CURVES (SE1L THRU SE4L)

FIG. 1 - TEST CIRCUIT DIAGRAM AND REVERSE RECOVERY TIME CHARACTERISTIC

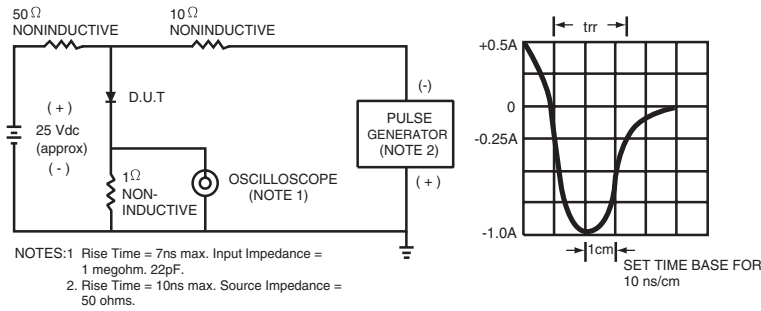

FIG. 2 - TYPICAL FORWARD CURRENT DERATING CURVE

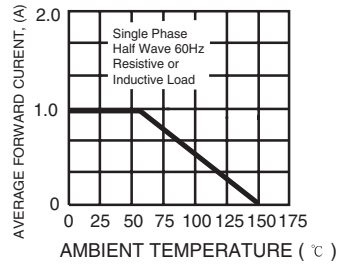

FIG. 3 - TYPICAL REVERSE CHARACTERISTICS

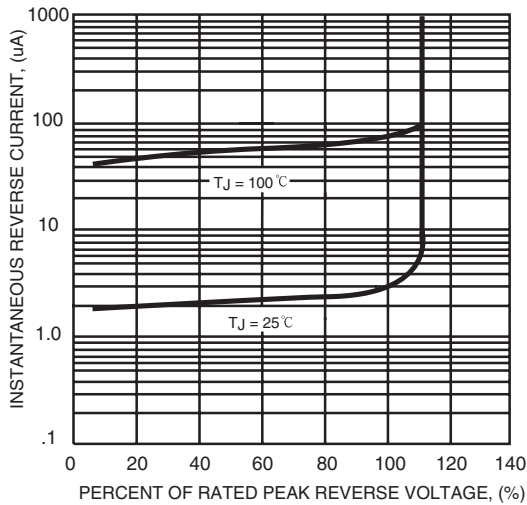

FIG. 4 - TYPICAL INSTANTANEOUS FORWARD CHARACTERISTICS

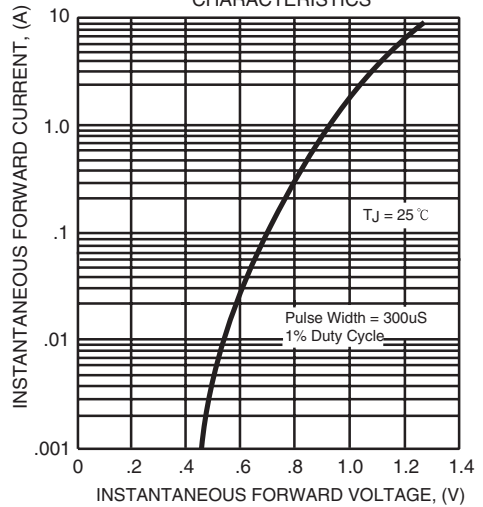

FIG. 5 - MAXIMUM NON-REPETITIVE FORWARD SURGE CURRENT

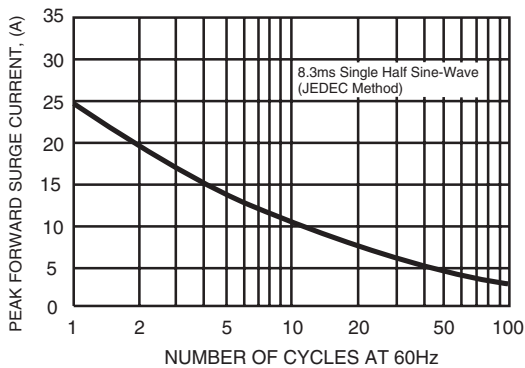
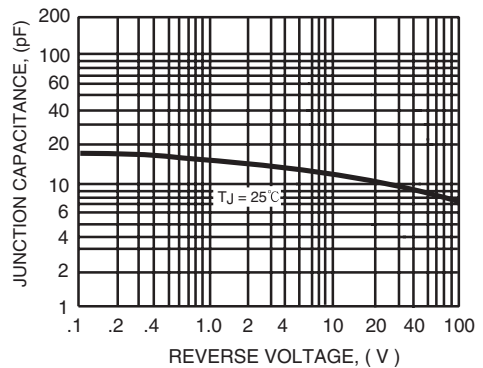
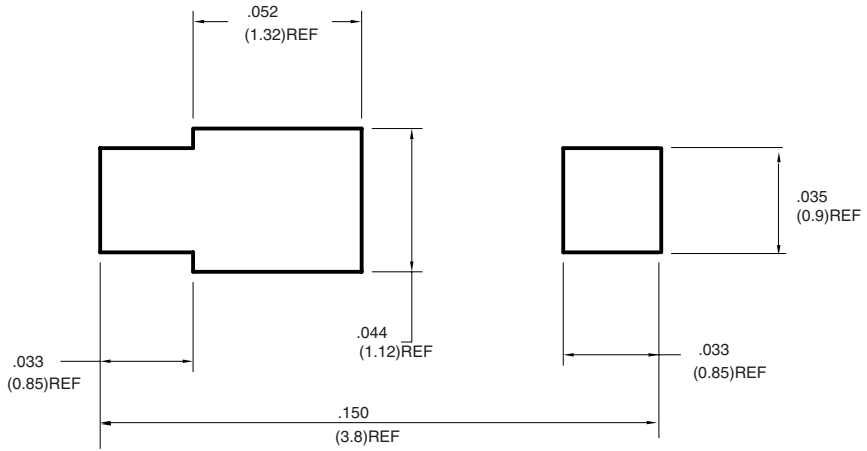

FIG. 6 - TYPICAL JUNCTION CAPACITANCE



Mounting Pad Layout



Dimensions in inches and (millimeters)

DISCLAIMER NOTICE

Rectron Inc reserves the right to make changes without notice to any product specification herein, to make corrections, modifications, enhancements or other changes. Rectron Inc or anyone on its behalf assumes no responsibility or liability for any errors or inaccuracies. Data sheet specifications and its information contained are intended to provide a product description only. "Typical" parameters which may be included on RECTRON data sheets and/ or specifications can and do vary in different applications and actual performance may vary over time. Rectron Inc does not assume any liability arising out of the application or use of any product or circuit.

Rectron products are not designed, intended or authorized for use in medical, life-saving implant or other applications intended for life-sustaining or other related applications where a failure or malfunction of component or circuitry may directly or indirectly cause injury or threaten a life without expressed written approval of Rectron Inc. Customers using or selling Rectron components for use in such applications do so at their own risk and shall agree to fully indemnify Rectron Inc and its subsidiaries harmless against all claims, damages and expenditures.