

SGB965360E

Output 24 to 600 VAC
3 x 50 ARMS
Input 10-30VDC



Relais Statique Triphasé 2 voies Two legs Three Phase Solid State Relays Entraxe 47,5mm /47.5mm mounting

- ❑ Relais statique synchrone Triphasé avec 1 voie directe adaptée aux charges résistives.
Three phase Zero Cross Solid State Relay with one directe connection designed for resistive loads.
- ❑ Sortie thyristors hautes performances technologie TMS² (*) permettant une longue durée de vie : **24 à 600VAC 50A**
New High Efficiency Back to back thyristors on output with TMS² technology() for a long lifetime expectancy: 24 to 600VAC 50A*
- ❑ Tension de commande 10 - 30VDC
LED de visualisation sur l'entrée de couleur verte.
Control range: 10-30VDC. Green LED visualization on the input.

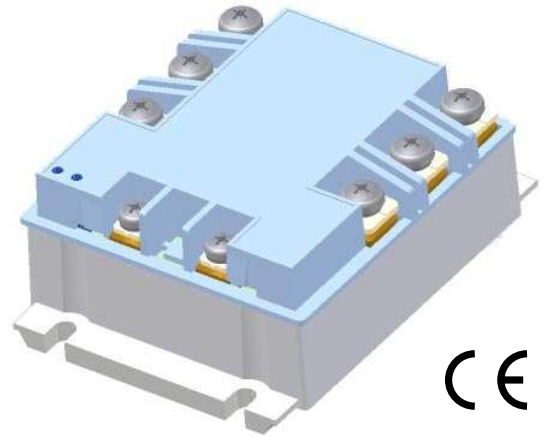

Application typique /Typical application:

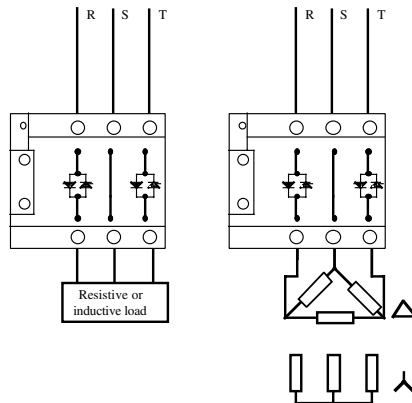

Circuit équivalent/Equivalent circuit :

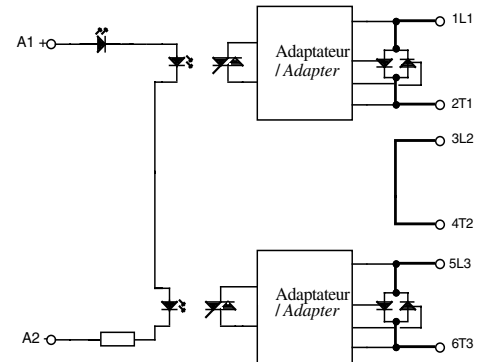

Caractéristiques de commande (à 20°C) / Control characteristics (at 20°C)

Paramètre / Parameter	Symbol	DC			Unit
		Min	Nom	Max	
Tension de commande / Control voltage	Uc	10	24	30	V
Courant de commande / Control current (@ U _c)	Ic	10	35	46	mA
Tension de relachement/Release voltage	U _{c off}	4			V
Résistance interne / Input internal resistor fig.1	R _c		550		Ω
Tension inverse / Reverse voltage	U _{rv}		30		V

Caractéristiques d'entrée-sortie (à 20°C) / Input-output characteristics (at 20°C)

Isolement entrée-sortie/Input-output isolation @500m	U _i		4000		VRMS
Isolement sortie-semelle/Output-case isolation @500m	U _i		3300		VRMS
Tension assignée isolement/ Rated impulse voltage	U _{imp}		4000		V

Caractéristiques générales / General characteristics

Paramètre / Parameter	Conditions	Symbol	Typ.	Unit
Poids/Weight			370	g
Plage de température de stockage / Storage temperature range			-40 / +100	°C
Plage de température de fonctionnement/Operating temperature range			-40 / +100	°C

(*) : Thermo Mechanical Stress Solution

Proud to serve you

All technical characteristics are subject to change without previous notice.
Caractéristiques sujettes à modifications sans préavis.

celduc[®]
r e l a i s

fig. 1 :Caractéristique d'entrée /
Control characteristic

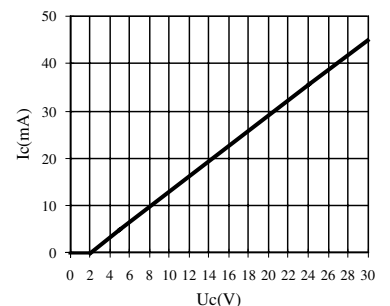

Caractéristiques de sortie / Output characteristics (at 25°C)

Paramètre / Parameter	Conditions	Symbol	Min	Typ.	Max	Unit
Plage de tension utilisation / Operating voltage range		Ue	24	400	520	V rms
Tension de crête / Peak voltage		Up	1200			V
Niveau de synchronisme / Zero cross level		U _{sync}			35	V
Tension minimum amorçage / Latching voltage	Ie nom	Ua	10			V
Courant nominal / nominal current (AC-51)		Ie AC-51		50	60	A rms
Courant surcharge / Non repetitive overload current	tp=10ms (Fig. 3)	I _{tsm}	530	580		A
Chute directe à l'état passant / On state voltage drop	@ 25°C	Vt			0,85	V
Résistance dynamique / On state dynamic resistance		rt			7,5	mΩ
Puissance dissipée (max) / Output power dissipation (max value)		Pd	$(0,9 \times 0,85 \times I_e + 0,0075 \times I_e^2) \times 2$			W
Résistance thermique jonction/semelle / Thermal resistance between junction to case		R _{thj/c}		0,4	0,55	K/W
Courant de fuite à l'état bloqué / Off state leakage current	@Ue typ, 50Hz	I _{lk}			1	mA
Courant minimum de charge / Minimum load current		I _{emin}	5			mA
Temps de fermeture / Turn on time	@Ue typ, 50Hz	ton max			10	ms
Temps d'ouverture / Turn off time	@Ue typ, 50Hz	toff max			10	ms
Fréquence utilisation / Operating frequency range	F mains	f	0,1	50-60	800	Hz
dv/dt à l'état bloqué / Off state dv/dt		dv/dt	500			V/μs
di/dt max / Maximum di/dt non repetitive		di/dt			50	A/μs
I _{2t} (<10ms)		I ² _t	1404	1680		A ² s
Immunité / Conducted immunity level	IEC/EN61000-4-4 (bursts)		2kV criterion B			
Immunité / Conducted immunity level	IEC/EN61000-4-5 (surge)		2kV criterion A with external VDR			
Protection court-circuit / Short circuit protection	voir/see page 5	Example	Fuse Ferraz gRC 25A/32A/50A			

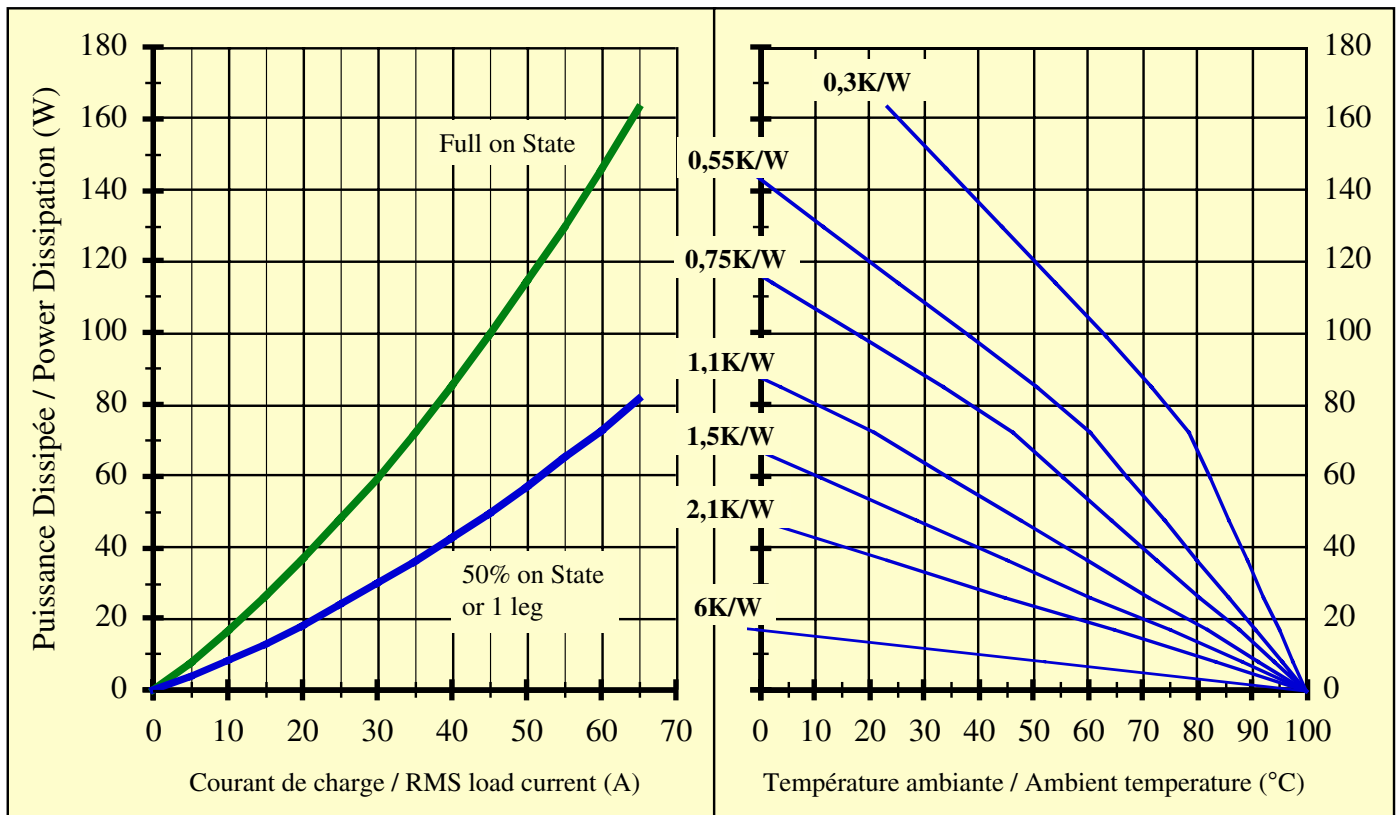
Caractéristiques thermiques / thermal curves :

Proud to serve you

celduc®

r e l a i s

fig 3 : Courants de surcharges / *Overload currents*

1 - *Itsm non répétitif* sans tension réappliquée est donné pour la détermination des protections.

1 - *No repetitive Itsm is given without voltage reapplied. This curve is used to define the protection (fuses).*

2 - *Itsm répétitif* est donné pour des surcharges de courant (T_j initiale=70°C).

Attention : la répétition de ces surcharges de courant diminue la durée de vie du relais.

2 - *Repetitive Itsm is given for inrush current with initial $T_j = 70^\circ\text{C}$. In normal operation, this curve mustn't be exceeded.*

Be careful, the repetition of the surge current decreases the life expectancy of the SSR.

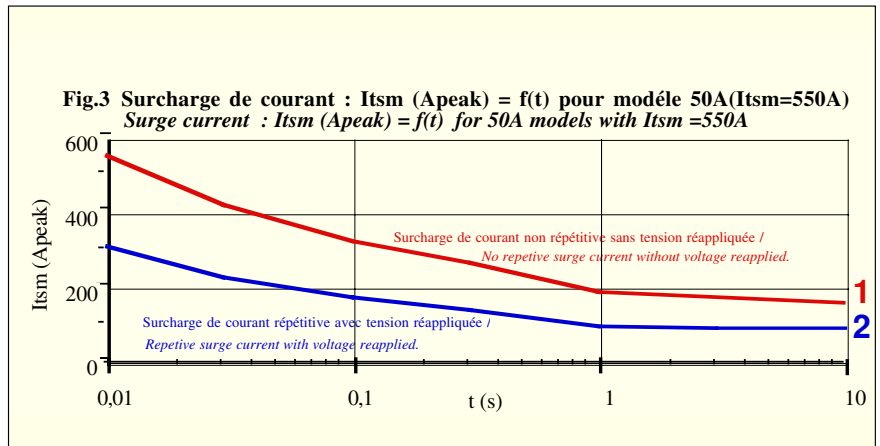

-> **Attention !** les relais à semi-conducteurs ne procurent pas d'isolation galvanique entre le réseau et la charge. Ils doivent être utilisés associés à un disjoncteur avec propriété de sectionnement ou similaire, afin d'assurer un sectionnement fiable en amont de la ligne dans l'hypothèse d'une défaillance et pour tous les cas où le relais doit être isolé du réseau (maintenance ; non utilisation sur une longue durée...).

-> **Warning !** *semiconductor relays don't provide any galvanic insulation between the load and the mains. Always use in conjunction with an adapted circuit breaker with isolation feature or a similar device in order to ensure a reliable insulation in the event of wrong function and when the relay must be insulated from the mains (maintenance ; if not used for a long duration ...).*

Dimensions

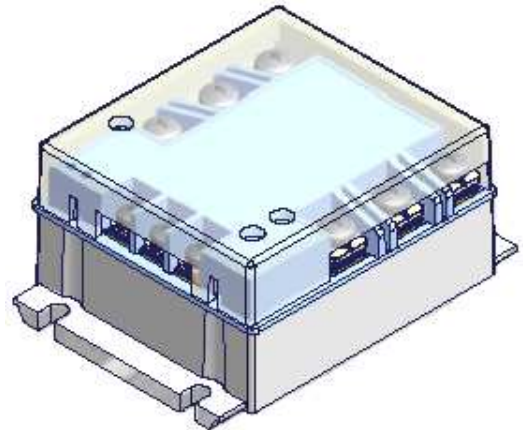
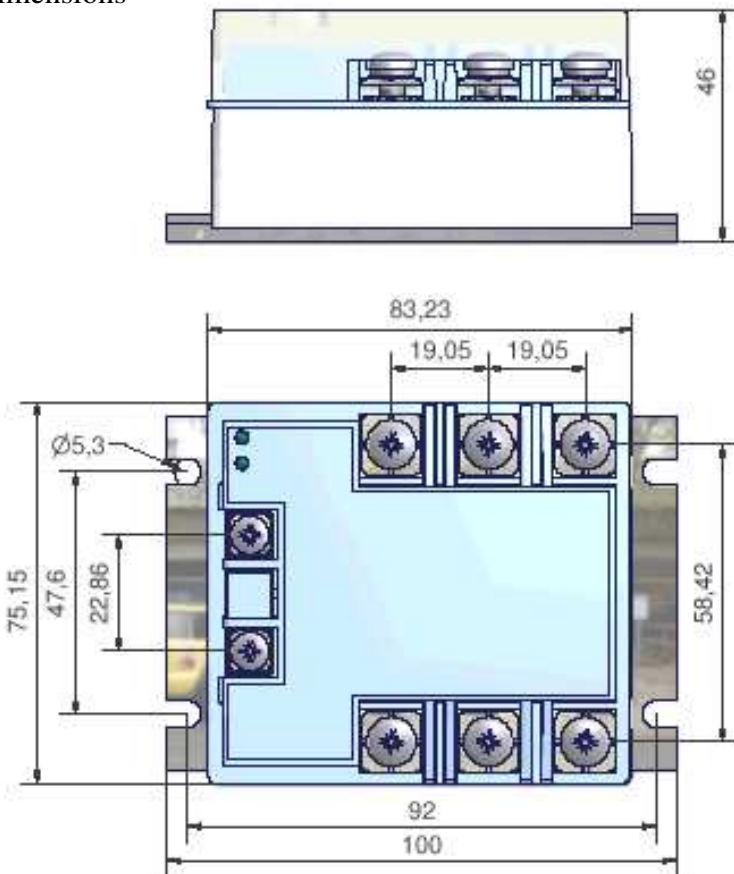

avec capot 1K199000

with transparent cover 1K199000

Proud to serve you

All technical characteristics are subject to change without previous notice.
 Caractéristiques sujettes à modifications sans préavis.

celduc®
 r e l a i s

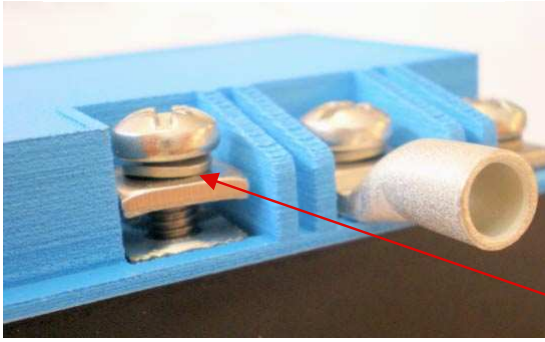





TERMINALS

M5 power connection

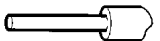

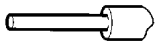
M4 control connection

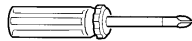
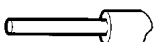
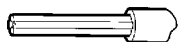
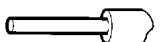
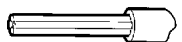
Nouvelles bornes avec rondelles freins
New terminals with washers

SGT HE				Raccordement d'entrée / Control wiring	
Nombre de fils / Number of wires				Modèle de tournevis / Screwdriver type	Couple de serrage recommandé Recommended Torque
1		2			
Fil rigide (sans embout) SOLID (No ferrule)	Fil multibrins (avec embout) FINE STRANDED (With ferrule)	Fil rigide (sans embout) SOLID (No ferrule)	Fil multibrins (avec embout) FINE STRANDED (With ferrule)		M4
					N.m
0,75 ... 2,5 mm ² AWG18...AWG14	0,75 ... 2,5 mm ² AWG18...AWG14	0,75 ... 2,5 mm ² AWG18...AWG14	0,75 ... 2,5 mm ² AWG18...AWG14	POZIDRIV 2	1,2
okpac®				Raccordement de puissance / Power wiring	
Nombre de fils / Number of wires				Modèle de tournevis / Screwdriver type	Couple de serrage recommandé Recommended Torque
1		2			
Fil rigide (sans embout) SOLID (No ferrule)	Fil multibrins (avec embout) FINE STRANDED (With ferrule)	Fil rigide (sans embout) SOLID (No ferrule)	Fil multibrins (avec embout) FINE STRANDED (With ferrule)		M5
					N.m
1,5 ... 10 mm ² AWG16...AWG8	1,5 ... 6 mm ² AWG16...AWG10	1,5 ... 10 mm ² AWG16...AWG8	1,5 ... 6 mm ² AWG16...AWG10	POZIDRIV 2	2
Puissance avec cosses / Power with ring terminals.  W max = 12,6mm  16 mm ² (AWG6) 25 mm ² (AWG4) 35mm ² (AWG2 /AWG3) 50mm ² (AWG0 /AWG1) 