

Contacteur Statique Triphasé Power Three Phase Solid State Contactor

SIT865570
(SVT865570-WH)
24-520 VAC - 3 x 50A
(AC-51 : 3 x 22 ARMS)
DC control

- ❑ Contacteur statique synchrone Triphasé prêt à l'emploi adapté aux charges résistives
Ready to use Three phase ZeroCross Solid State Contactor designed for resistive loads.
- ❑ Sortie thyristors hautes performances technologie TMS² (*) permettant une longue durée de vie: **24 à 520VAC 50A** ($I^2t > 1500A^2s$)
New High Efficiency Back to back thyristors on output with TMS² technology() for a long lifetime expectancy: 24 to 520VAC 50A $I^2t > 1500A^2s$ (**)*
- ❑ Tension de commande 10-30VDC
LED de visualisation sur l'entrée de couleur verte.
*Control range: 10-30VDC.
Green LED visualization on the input.*
- ❑ Protection de la tension de sortie par varistor.
Output voltage protection by VDR
- ❑ Livré en standard avec dissipateur intégré montable sur rail DIN et protection contre le toucher IP20
Delivered with integrated heatsink for DIN rail mounting and with IP20 protection cover.
- ❑ Construit en conformité aux normes EN60947-4-3 (IEC947-4-3) et EN60950/VDE0805 (Isolement renforcé) -UL-cUL
Designed in conformity with EN60947-4-3 (IEC947-4-3) and EN60950/VDE0805 (Reinforced Insulation) -UL-cUL

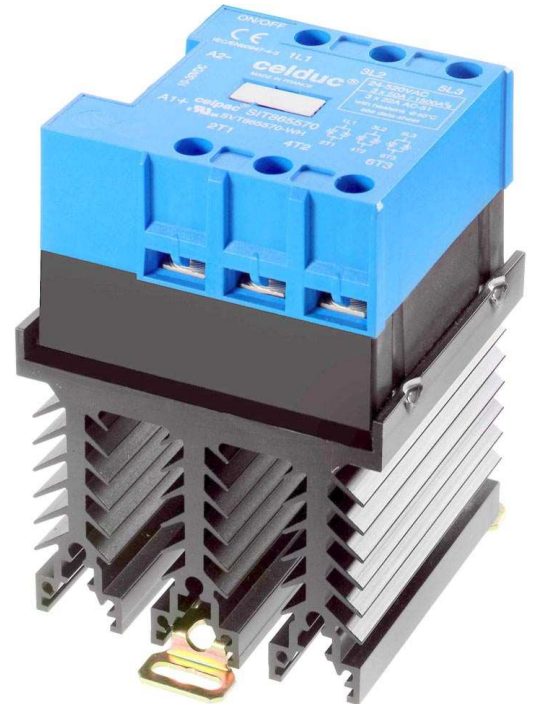

UL US
(SVT865570)

(**): Modèle 5000A²s sur demande ; 5000A²s model on request

Caractéristiques de commande (à 20°C) / Control characteristics (at 20°C)

Paramètre / Parameter	Symbol	DC			Unit
		Min	Nom	Max	
Tension de commande / Control voltage : DC	Uc	10	24	30	VDC
Courant de commande / Control current (@ Uc)	Ic	10	32	42	mA
Tension de relachement/Release voltage	Uc off	4			V
Résistance interne / Input internal resistor fig.1	Rc		560		Ω
Tension inverse / Reverse voltage	Urv		30		V

fig. 1 : Caractéristique d'entrée / Control characteristic

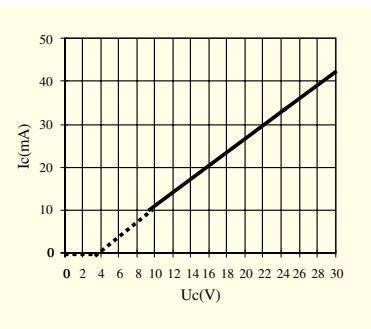

Caractéristiques d'entrée-sortie (à 20°C) / Input-output characteristics (at 20°C)

Isolément entrée-sortie/Input-output isolation @500m	Ui	4000		VRMS
Isolément sortie-semelle/Output-case isolation @500m	Ui	3300		VRMS
Tension assignée isolement/ Rated impulse voltage	Uimp	4000		V

General characteristics

Parameter	Conditions	Symbol	Typ.	Unit
Poids/Weight			1000	g
Température de fonctionnement / Ambient temperature (no icing, no condensation)			-40 / +100	°C
Température de stockage/ Storage temperature (no icing, no condensation)			-40 / +80	°C

(*) : Thermo Mechanical Stress Solution

Proud to serve you

All technical characteristics are subject to change without previous notice.
Caractéristiques sujettes à modifications sans préavis.

celduc®
r e l a i s

Caractéristiques de sortie / Output characteristics (at 25°C)

Paramètre / Parameter	Conditions	Symbol	Min	Typ.	Max	Unit
Plage de tension utilisation / Operating voltage range		Ue	24	400	520	V rms
Tension de crête (écrêtage VDR)/ Peak voltage (VDR clamping)	@ 1mA	Up	1200 (950)			V
Niveau de synchronisme / Zero cross level		U _{sync}			35	V
Tension minimum amorçage / Latching voltage	Ie nom	Ua	10			V
Courant nominal / nominal current (AC-51)	Resistance	Ie AC-51	50 (see derating curve)			A rms
Courant nominal / nominal current (AC-53)	Motor	Ie AC-53		12		A rms
Courant surcharge / Non repetitive overload current	tp=10ms (Fig. 3)	I _{tsm}	550	720		A
Chute directe à l'état passant / On state voltage drop	@ 25°C	Vt			0,9	V
Résistance dynamique / On state dynamic resistance		rt			12	mΩ
Puissance dissipée (max) / Output power dissipation (max value)		Pd	(0,9x0,9xIe + 0,012xIe ²)*3			W
Résistance thermique jonction/semelle / Thermal resistance between junction to case		Rthj/c		1 leg	0,45	K/W
Courant de fuite à l'état bloqué / Off state leakage current	@Ue typ, 50Hz	I _{lk}			1	mA
Courant minimum de charge / Minimum load current		I _{emin}	5			mA
Temps de fermeture / Turn on time	@Ue typ, 50Hz	ton max			10	ms
Temps d'ouverture / Turn off time	@Ue typ, 50Hz	toff max			10	ms
Fréquence utilisation/ Operating frequency range	F mains	f	0,1	50-60	800	Hz
dv/dt à l'état bloqué / Off state dv/dt		dv/dt	500			V/μs
di/dt max / Maximum di/dt non repetitive		di/dt			50	A/μs
I _{2t} (<10ms)		I ² _t	1500	2500		A ² s
Immunité / Conducted immunity level	IEC/EN61000-4-4 (bursts)		4kV criterion A			
Immunité / Conducted immunity level	IEC/EN61000-4-5 (surge)		4kV criterion A			
Protection court-circuit / Short circuit protection	voir/see page 6	Example	Fuse Ferraz gRC 25A/32A/50A			

COURBES THERMIQUES / thermal curves:**curve 1 :**

with ventilation in the heatsink (> 1m/s)
(avec ventilation significative du dissipateur)

curve 2 :

working in normal conditions with a small
ventilation in the cabinet (avec petite ventila-
tion d'armoire)

curve 3 :

according with IEC60947-4-2
in a closed cabinet without any ventilation.
(absence totale de ventilation)

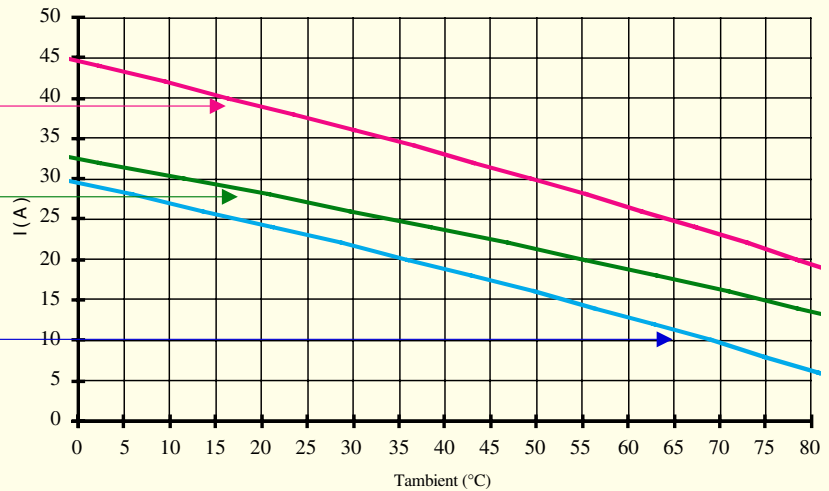

1 -I_{tsm} non répétitif sans tension réappliquée est donné pour la détermination des protections.

1 - *No repetitive I_{tsm} is given without voltage reapplied. This curve is used to define the protection (fuses).*

2 -I_{tsm} répétitif est donné pour des surcharges de courant (T_j initiale=70°C).

Attention : la répétition de ces surcharges de courant diminue la durée de vie du relais.

2 - *Repetitive I_{tsm} is given for inrush current with initial T_j = 70°C. In normal operation, this curve musn't be exceeded.*

Be careful, the repetition of the surge current decreases the life expectancy of the SSR.

fig 3 : Courants de surcharges / Overload currents

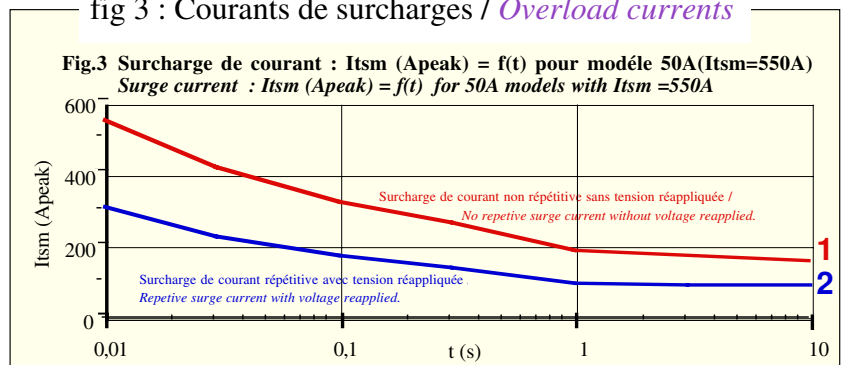

ISO 9001
N° 1993/1106a



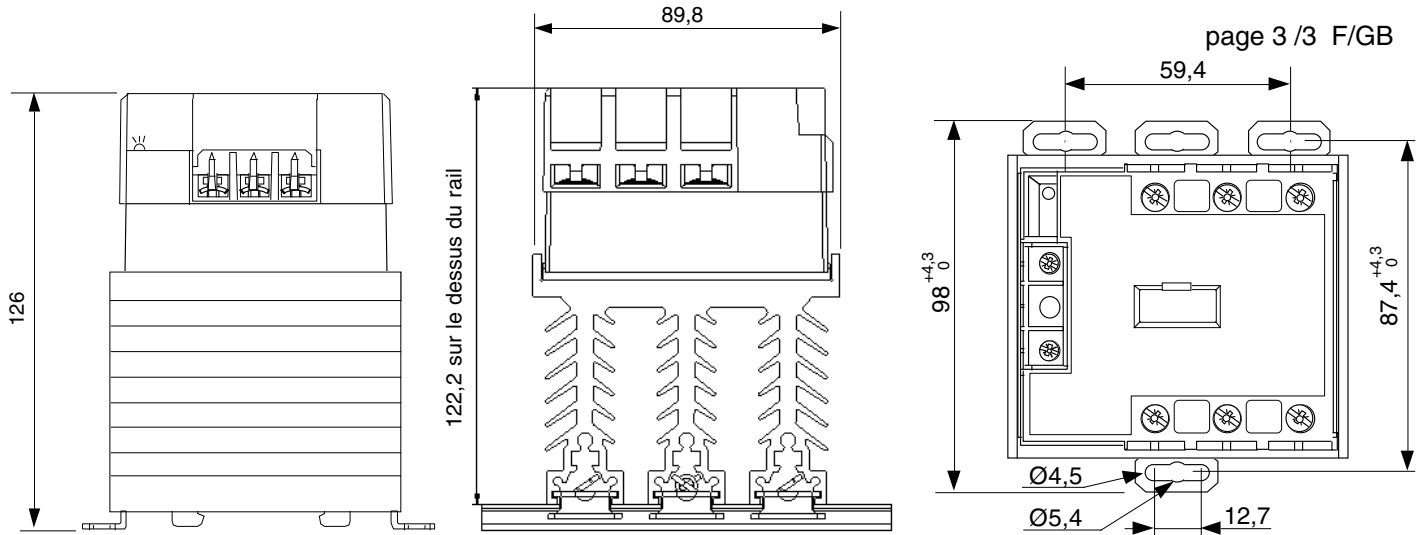

celduc[®]
r e l a i s

www.celduc.com

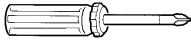
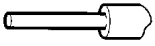
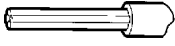
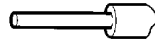
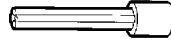
5 Rue Ampère B.P. 30004 42290 SORBIERS - FRANCE E-Mail : celduc-relais@celduc.com
Fax +33 (0) 4 77 53 85 51 Service Commercial France Tél. : +33 (0) 4 77 53 90 20
Sales Dept.For Europe Tel. : +33 (0) 4 77 53 90 21 Sales Dept. Asia : Tél. +33 (0) 4 77 53 90 19

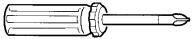
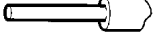

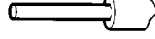
SIT/SVT				Raccordement d'entrée / Control wiring	
Nombre de fils / Number of wires				Modèle de tournevis / Screwdriver type	Couple de serrage recommandé Recommended Torque
1		2			
Fil rigide (sans embout) SOLID (No ferrule)	Fil multibrins (avec embout) FINE STRANDED (With ferrule)	Fil rigide (sans embout) SOLID (No ferrule)	Fil multibrins (avec embout) FINE STRANDED (With ferrule)		M4
					N.m
0,75 ... 2,5 mm ² AWG18....AWG14	0,75 ... 2,5 mm ² AWG18....AWG14	0,75 ... 2,5 mm ² AWG18....AWG14	0,75 ... 2,5 mm ² AWG18....AWG14	POZIDRIV 2	1,2

celpac [®]				Raccordement de puissance / Power wiring	
Nombre de fils / Number of wires				Modèle de tournevis / Screwdriver type	Couple de serrage recommandé Recommended Torque
1		2			
Fil rigide (sans embout) SOLID (No ferrule)	Fil multibrins (avec embout) FINE STRANDED (With ferrule)	Fil rigide (sans embout) SOLID (No ferrule)	Fil multibrins (avec embout) FINE STRANDED (With ferrule)		M5
					N.m
1,5 ... 10 mm ² AWG16....AWG8	1,5 ... 6 mm ² AWG16....AWG10	1,5 ... 10 mm ² AWG16....AWG8	1,5 ... 6 mm ² AWG16....AWG10	POZIDRIV 2	2



ISO 9001
N° 1993/1106a

celduc[®]
r e l a i s

www.celduc.com

5 Rue Ampère B.P. 30004 42290 SORBIERS - FRANCE E-Mail : celduc-relais@celduc.com
 Fax +33 (0) 4 77 53 85 51 Service Commercial France Tél. : +33 (0) 4 77 53 90 20
 Sales Dept.For Europe Tel. : +33 (0) 4 77 53 90 21 Sales Dept. Asia : Tél. +33 (0) 4 77 53 90 19

APPLICATION TYPIQUE

Typical application:

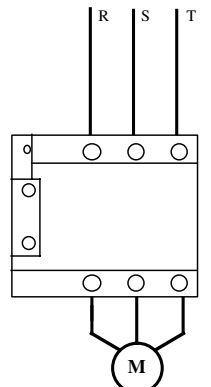
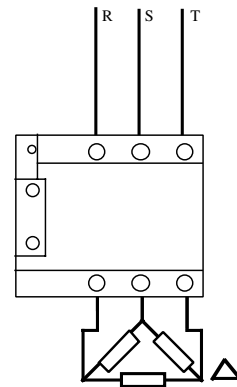
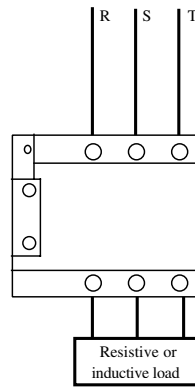
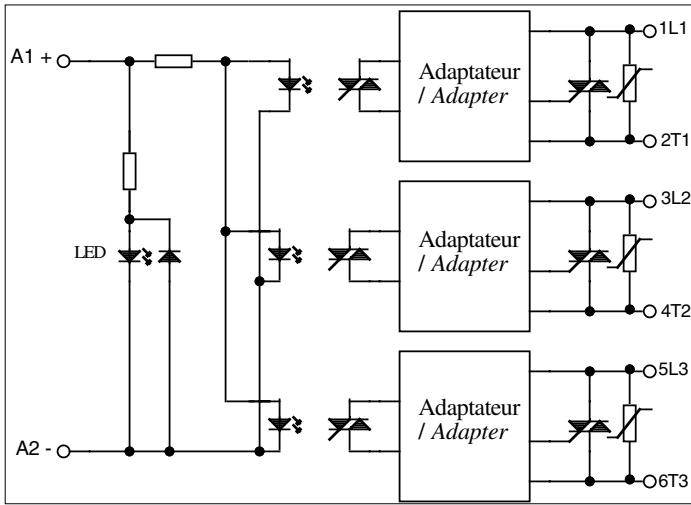

For motor use
SIT865390 or
SVT865990

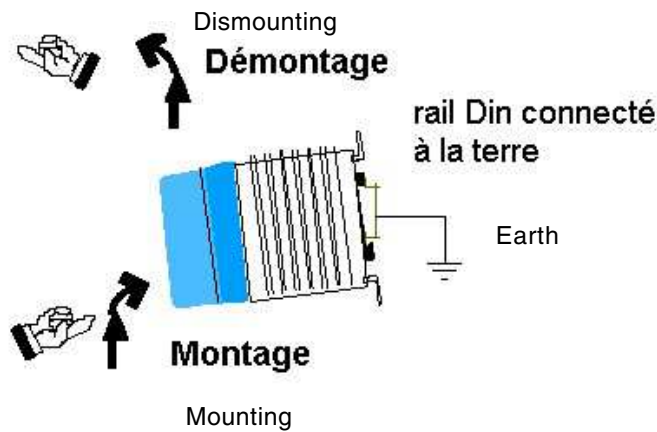

celduc[®]
r e l a i s

www.celduc.com

5 Rue Ampère B.P. 30004 42290 SORBIERS - FRANCE E-Mail : celduc-relais@celduc.com
 Fax +33 (0) 4 77 53 85 51 Service Commercial France Tél. : +33 (0) 4 77 53 90 20
 Sales Dept.For Europe Tel. : +33 (0) 4 77 53 90 21 Sales Dept. Asia : Tél. +33 (0) 4 77 53 90 19