

Relais Statique Triphasé

Three Phase Solid State Relays

SWT862090

24 to 520 VAC - 3 x 32 ARMS
11000A² s

- Relais synchrone sortie AC Prêt à l'emploi
- Commande 90-240VAC . LED.
- Protection interne par RC et écrêteur de tension .
- IP20
- Zero cross AC output. For all types of loads
- 90-240VAC control voltage with LED
- Internal protection by and clamping voltage.
- IP20

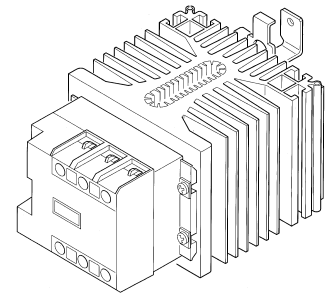

Dimensions / Dimensions:

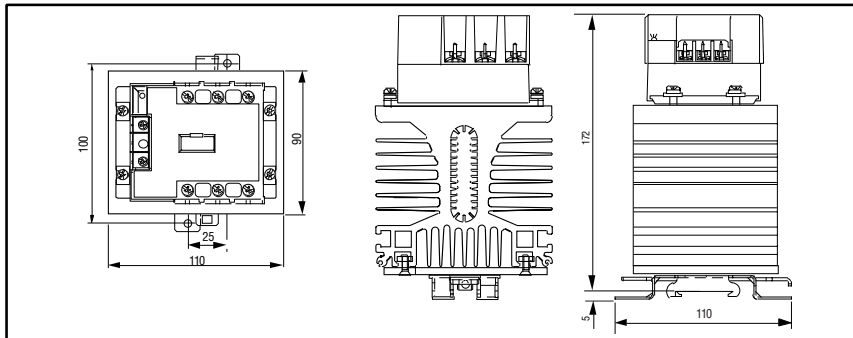

Circuit équivalent/Equivalent circuit :

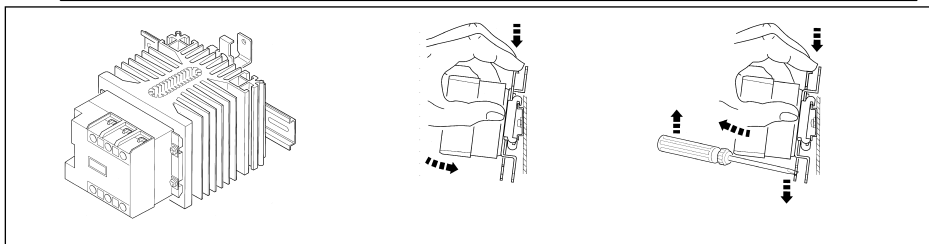
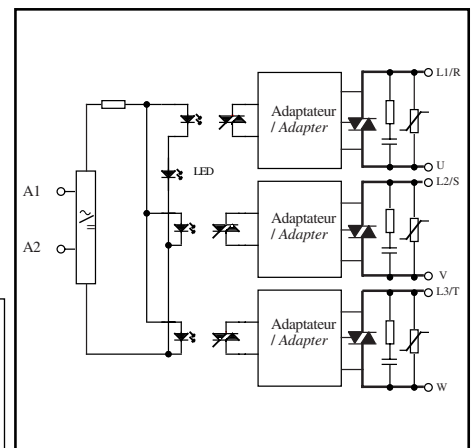

Caractéristiques de commande (à 20°C) / Control characteristics (at 20°C)

| Paramètre / Parameter | Symbol | AC-DC | | | Unit |
|--|--------|-------|---------------|-----|------|
| | | Min | Nom | Max | |
| Tension de commande / Control voltage : DC | Uc | 90 | | 240 | VDC |
| Tension de commande / Control voltage : AC | Uc | 90 | | 240 | VAC |
| Courant de commande / Control current (@ Uc) | Ic | 4,5 | | 11 | mA |
| Tension de relachement/Release voltage | Uc off | 15 | | | V |
| Résistance interne / Input internal resistor fig.1 | Rc | | 21 | | KΩ |
| Tension inverse / Reverse voltage | Urv | | polarity free | | V |

fig. 1 :Caractéristique d'entrée / Control characteristic

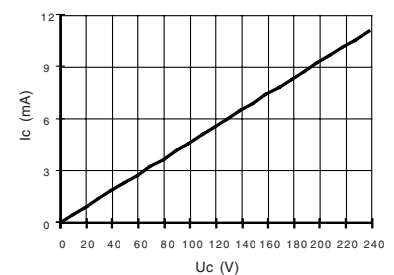

Caractéristiques d'entrée-sortie (à 20°C) / Input-output characteristics (at 20°C)

| | | | | | |
|--|------|--|------|--|------|
| Isolement entrée-sortie/Input-output isolation @500m | Ui | | 4000 | | VRMS |
| Isolement sortie-semelle/Output-case isolation @500m | Ui | | 3300 | | VRMS |
| Tension assignée isolement/ Rated impulse voltage | Uimp | | 4000 | | V |

Caractéristiques générales / General characteristics

| Paramètre / Parameter | Conditions | Symbol | Typ. | Unit |
|--|------------|--------|------------|------|
| Poids/Weight | | | 1900 | g |
| Plage de température de stockage / Storage temperature range | | | -40 / +100 | °C |
| Plage de température de fonctionnement/Operating temperature range | | | -40 / +100 | °C |

Proud to serve you

celduc[®]
r e l a i s

Caractéristiques de sortie(à 20°C) / Output characteristics (at 20°C)

| Paramètre / Parameter | Conditions | Symbol | Typ. | Unit |
|---|-----------------------|------------------|--------|------------------|
| Tension de charge / Load voltage | | Ue | 400 | V rms |
| Plage tension de fonctionnement / Operating range | (480Vrms + 10%) | Uemax | 530 | V rms |
| Tension crête / Peak voltage | | Up | 1200 | V |
| Niveau de synchronisation / Synchronizing level | | Usync | 12 | V |
| Tension d'amorçage / Latching voltage | Ie nom | Ua | 10 | V |
| Courant nominal AC-51 non permanent/ AC-51 no permanent nominal current | (see Fig. 2) | Ie AC-51 | 95 | A rms |
| Courant nominal AC-51/ AC-51 nominal current @25°C | (see Fig. 2) | Ie AC-51 | 3x32 | A rms |
| Courant nominal AC-53/ AC-53 nominal current | (see Fig. 2) | Ie AC-53 | 24 | A rms |
| Puissance max (moteur triphasé) Max 3 pole motor power (400 VAC) | | Pn | 11 | kW |
| Puissance max (moteur triphasé) 3 pole motor power(400VAC)/EN60947-2 | | Pn | 7,5 | kW |
| Courant de surcharge non répétitif / Non repetitive overload current | tp=10ms (Fig. 3) | I _{tsm} | 1500 | A |
| Chute tension directe crête/ On state voltage drop | @ Ie nom | Vd | 1,4 | V |
| Courant de fuite état bloqué/ Off state leakage current | @Ue, 50Hz | I _{lk} | 2,5 | mA |
| Courant de charge minimum / Minimum load current | | Ie min | 5 | mA |
| Temps de fermeture/ Turn on time | Uc nom DC ,f=50Hz | ton max | 30 | ms |
| Temps d'ouverture/ Turn off time | Uc nom DC ,f=50Hz | toff max | 30 | ms |
| Plage de fréquence / Operating frequency range | | f | 10-400 | Hz |
| dv/dt état bloqué / Off state dv/dt | | dv/dt | 500 | V/μs |
| dI/dt maximum non répétitif/ Maximum di/dt non repetitive | | di/dt | 50 | A/μs |
| I ² t (<10ms) | | I ² t | 11000 | A ² s |
| EMC Test d'immunité conduite / Conducted immunity level | IEC 1000-4-4 (burst) | 4kV criterion A | | |
| EMC Test d'immunité conduite / Conducted immunity level | IEC 1000-4-5(schocks) | 2kV crit.A | | |
| Conformité / Conformity | EN60947-4-x | | | |

Caractéristiques thermiques / thermal curves :

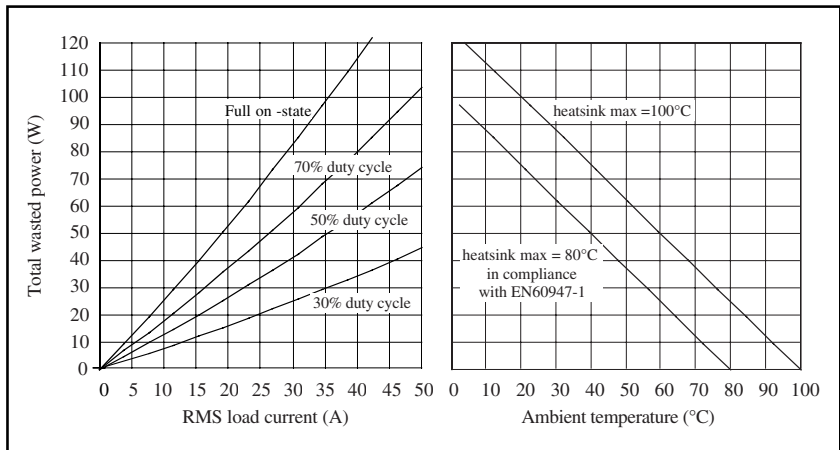
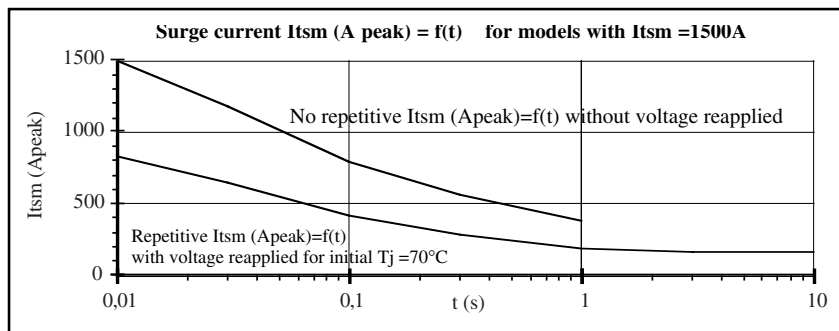

Fig.3 Courbes de surcharge de courant / Overload current curves



1 -I_{tsm} non répétitif sans tension réappliquée est donné pour la détermination des protections.
No repetitive I_{tsm} is given without voltage reapplied for the determination of the protection.

2 -I_{tsm} répétitif est donné pour des surcharges de courant (T_j initiale=70°C). La répétition de ces surcharges de courant diminue la durée de vie du Relais.
Repetitive I_{tsm} is given for inrush current with initial T_j = 70°C. The repetition of the surge current decrease the lifetime SSR's .

Précautions :

* Les relais à semiconducteurs ne procurent pas d'isolation galvanique entre le réseau et la charge.





Cautions :



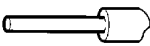

* Semiconductor relays don't provide any galvanic insulation between the load and the mains.

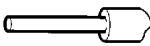
Proud to serve you

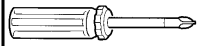
All technical characteristics are subject to change without previous notice.
Caractéristiques sujettes à modifications sans préavis.

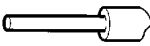
celduc®
r e l a i s

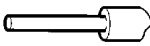
| SVT Cablage commande / Wiring of the control circuit: | | | | | | |
|---|---|---|---|--|---|----------------------------------|
| nombre de fils/ NUMBER OF WIRES | | | | SCREWDRIVER TYPE | | MINIMUM TORQUE couple serrage |
| 1 | | 2 | | tournevis | tournevis | |
| SOLID (No ferrule) rigide sans embout | FINE STRANDED (With ferrule) multibrins avec embouts | SOLID (No ferrule) rigide sans embout | FINE STRANDED (With ferrule) multibrins avec embouts | | | |
|  |  |  |  |  |  | N.m |
| 0,75 ... 2,5 mm ² | 0,75 ... 2,5 mm ² | 0,75 ... 2,5 mm ² | 0,75 ... 2,5 mm ² | 0,8 x 5,5 mm | POZIDRIV 2 | 1,2 |

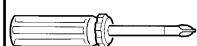
| SVT Cablage puissance / Wiring of the power circuit: | | | | | | |
|---|---|---|---|--|---|----------------------------------|
| NUMBER OF WIRES | | | | SCREWDRIVER TYPE | | MINIMUM TORQUE couple serrage |
| 1 | | 2 | | tournevis | tournevis | |
| SOLID (No ferrule) rigide sans embout | FINE STRANDED (With ferrule) multibrins avec embouts | SOLID (No ferrule) rigide sans embout | FINE STRANDED (With ferrule) multibrins avec embouts | | | |
|  |  |  |  |  |  | N.m |
| 1,5 ... 10 mm ² | 1,5 ... 6 mm ² | 1,5 ... 10 mm ² | 1,5 ... 6 mm ² | 0,8 x 5,5 mm | POZIDRIV 2 | 1,8 |

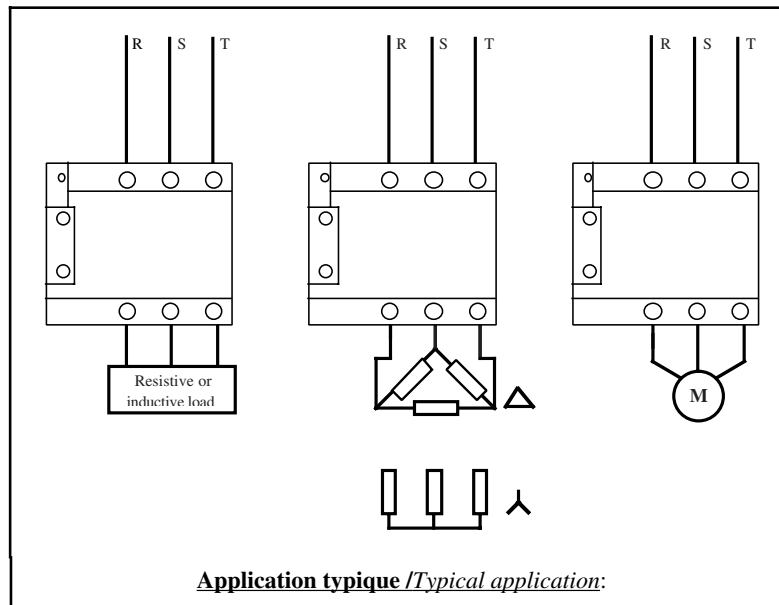

ISO 9001
N° 1993/1106a

celduc[®]
r e l a i s

www.celduc.com

Rue Ampère B.P. 4 42290 SORBIERS - FRANCE E-Mail : celduc-relais@celduc.com
 Fax +33 (0) 4 77 53 85 51 Service Commercial France Tél. : +33 (0) 4 77 53 90 20
 Sales Dept. For Europe Tel. : +33 (0) 4 77 53 90 21 Sales Dept. Asia : Tél. +33 (0) 4 77 53 90 19