

# Dissipateur thermique Heatsink

# WF112100

Rth: 1K/W

- Dissipateur thermique pour relais statique 22.5mm **celpac** SA & SU  
Heatsink for 22.5mm **SA & SU celpac** Solid State Relay
- Utiliser de la graisse thermique ou un thermal PAD avec les vis et les couples de serrage péconisés.  
Use thermal grease or thermal PAD with adapted screws and washers at the right mounting torque.

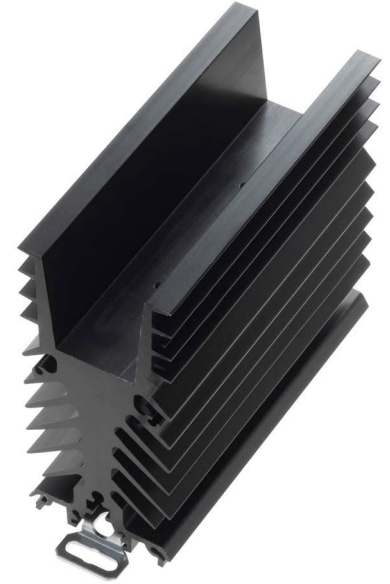

Performances thermiques en montage vertical  
Thermal performances in vertical mounting

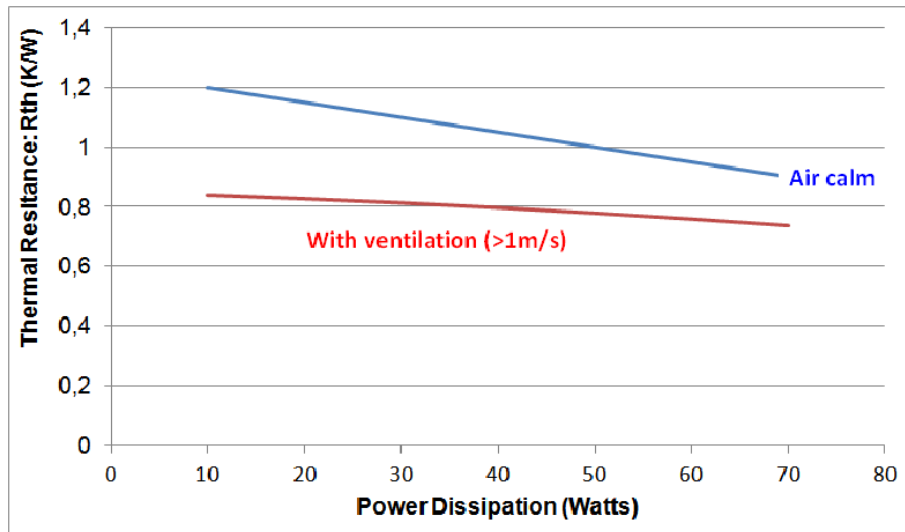

Proud to serve you

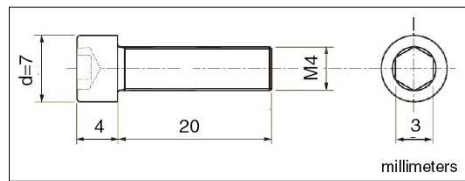
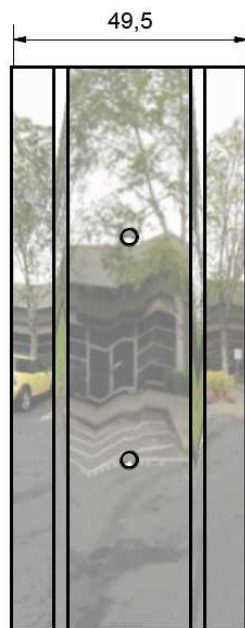
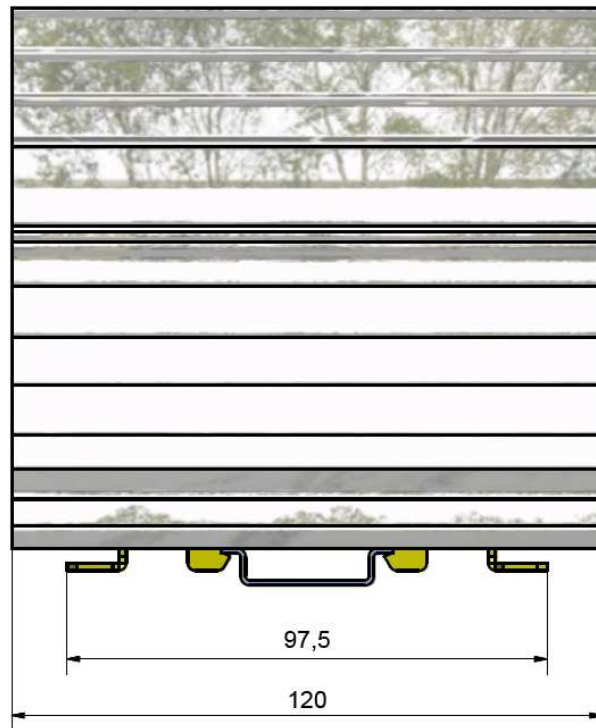
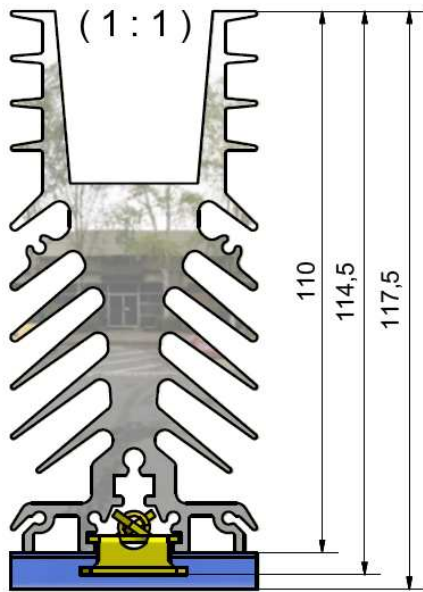

1L184200  
Screws M4x20 stainless A2

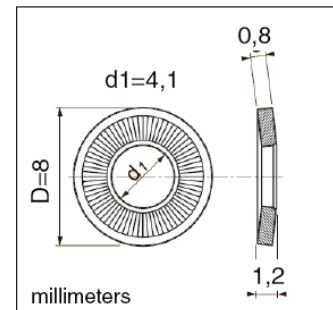

1L344000  
washer Ø8  
bright zinc plated or  
stainless A2

**Couple de serrage préconisé pour les 2 vis : 1.8Nm**  
**Advise torque for the 2 screws : 1.8Nm**