

Dimensions

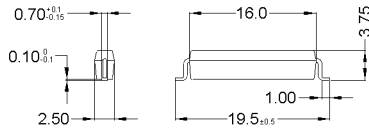

unspecified tolerances $\pm 0.1\text{mm}$
 nicht spezifizierte Toleranzen $\pm 0.1\text{mm}$

Marking

Sensitivity and DateCode
 EN60062

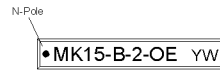

Lötvorschrift / soldering information

reflow soldering conditions according to JEDEC norm J-STD-020C

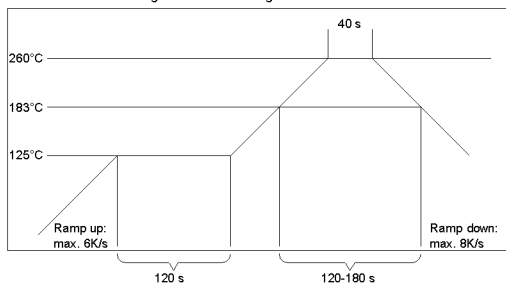

Tape and Reel Packaging (IEC 60286-3)

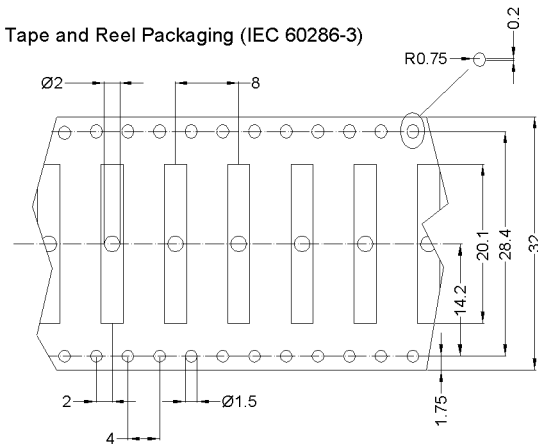

MAGNET RECOMMENDATION
 (examples)

NdFeB - N35, Ø3 x 2mm
 $M_{typ} = 1,39 \times 10E-6 \text{ Vs}^*cm$
 $M_{min} = 2,80 \times 10E-6 \text{ Vs}^*cm$
 andere Magnete sind
 zulässig /
 other magnets are allowable

Magnet - Mindestabstand zum
 Sensor: 1,0 mm
 (min. distance to sensor)

**direkte Berührung mit dem
 Betätigungsmagnet kann die Empfindlichkeit
 verändern !!!**
 (by direct touch may be changed sensitivity)

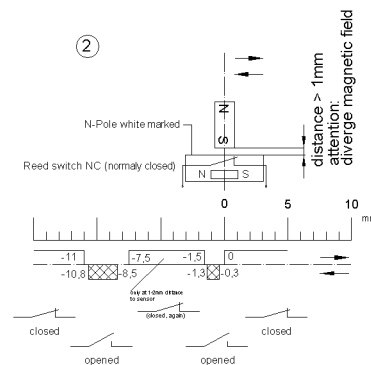
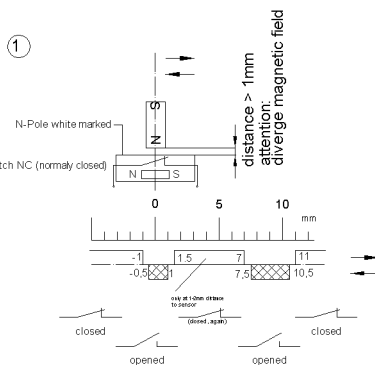
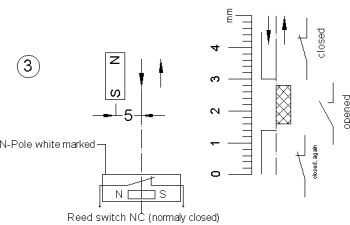



Europe: +49 / 7731 8399 0 | Email: info@meder.com
 USA: +1 / 508 295 0771 | Email: salesusa@meder.com
 Asia: +852 / 2955 1682 | Email: salesasia@meder.com

Item No.:
9150100022
 Item:
MK15-B-2-OE

Products for tomorrow...

Magnetic properties	Conditions	Min	Typ	Max	Unit
Pull-In	at 20 °C	15		45	
Drop out	at 20 °C	10		35	
Test equipment		KMS-11			
Pull-In in milliTesla (modified conta	MS150 - phys. caused tolerance +/- 0,1mT	0,8		2,1	mT
Drop-Out in milliTesla (modified co	MS150 - phys. caused tolerance +/- 0,1mT	0,6		1,7	mT
Test equipment		MS-150			

Contact data 66/1	Conditions	Min	Typ	Max	Unit
Contact-No.		66			
Contact-form		B - NC			
Contact-material		Rhodium			
Contact rating	Any DC combination of V & A not to exceed their individual max.'s			10	W
Switching voltage	DC or Peak AC			180	VDC
Carry current	DC or Peak AC			1,25	A
Switching current	DC or Peak AC			0,5	A
Contact resistance static	Measured with 40% overdrive Start Value			150	mOhm
Breakdown voltage (>20 AT)	according to IEC 255-5	200			VDC

Special Product Data	Conditions	Min	Typ	Max	Unit
Housing material		mineral-filled epoxy			
Remark		no direct touch between sensor and strong magnets!			

Environmental data	Conditions	Min	Typ	Max	Unit
Shock	1/2 sine wave duration 11ms			30	g
Vibration	from 10 - 2000 Hz			20	g
Ambient temperature		-40		130	°C
Storage temperature		-50		130	°C
Cleaning		fully sealed			

Modifications in the sense of technical progress are reserved

Designed at: 19.11.07 Designed by: THAUKE
 Last Change at: 22.11.10 Last Change by: THAUKE

Approval at: 03.01.08 Approval by: JHEYDER
 Approval at: 24.11.10 Approval by: JHEYDER

Version: 6