

### Features

- ◆ Highest power density:  
40 W in 1" x 2" x 0.4" package
- ◆ Excellent efficiency up to 92 %
- ◆ Output voltage adjustable
- ◆ Remote On/Off
- ◆ Short circuit protection
- ◆ Over voltage protection
- ◆ I/O isolation 1500 VDC
- ◆ Operating temperature range  
-40°C to +80°C
- ◆ Fully RoHS compliant
- ◆ 3-year product warranty



The TEN 40N Series is a new range of isolated high performance dc-dc converter modules. Due to the very high efficiency of up to 92% these 40 W converters come with a footprint of only 1.0" x 2.0". The 15 models have a wide 2:1 input voltage range and a tight output voltage regulation. The output voltage is adjustable by external resistor. Remote On/Off and protection against overpower and overvoltage are standard features of these converters.

Typical applications are in mobile equipment, instrumentation, distributed power architectures in communication and industrial electronics and everywhere where space on the PCB is critical.

### Models

Order code	Input voltage range	Output voltage	Output current max.	Efficiency
TEN 40-1210N	9 – 18 VDC (nominal 12 VDC)	3.3 VDC	8'000 mA	89 %
TEN 40-1211N		5.0 VDC	8'000 mA	89 %
TEN 40-1212N		12 VDC	3'333 mA	89 %
TEN 40-1213N		15 VDC	2'670 mA	90 %
TEN 40-1215N		24 VDC	1'670 mA	91 %
TEN 40-1222N		±12 VDC	±1'670 mA	88 %
TEN 40-1223N		±15 VDC	±1'330 mA	88 %
TEN 40-2410N	18 – 36 VDC (nominal 24 VDC)	3.3 VDC	8'000 mA	90 %
TEN 40-2411N		5.0 VDC	8'000 mA	91 %
TEN 40-2412N		12 VDC	3'333 mA	91 %
TEN 40-2413N		15 VDC	2'670 mA	91 %
TEN 40-2415N		24 VDC	1'670 mA	91 %
TEN 40-2422N		±12 VDC	±1'670 mA	89 %
TEN 40-2423N		±15 VDC	±1'330 mA	89 %
TEN 40-4810N	36 – 75 VDC (nominal 48 VDC)	3.3 VDC	8'000 mA	90 %
TEN 40-4811N		5.0 VDC	8'000 mA	91 %
TEN 40-4812N		12 VDC	3'333 mA	92 %
TEN 40-4813N		15 VDC	2'670 mA	92 %
TEN 40-4815N		24 VDC	1'670 mA	91 %
TEN 40-4822N		±12 VDC	1'670 mA	89 %
TEN 40-4823N		±15 VDC	1'330 mA	89 %

### Input Specifications

Input current at no load (nominal input voltage)	12 Vin;	3.3 VDC models:	120 mA typ.
	12 Vin;	5.0, 12 & 24 VDC models:	160 mA typ.
	12 Vin;	15 VDC models:	150 mA typ.
	12 Vin;	12 & 15 VDC dual output models:	70 mA typ. / 60 mA typ.
	24 Vin;	3.3 & 15 VDC models:	75 mA typ.
	24 Vin;	5.0, 12 & 24 VDC models:	80 mA typ. / 85 mA typ.
	24 Vin;	12 & 15 VDC dual output models:	50 mA typ. / 45 mA typ.
	48 Vin;	3.3 VDC models:	40 mA typ.
48 Vin;	other single output models:	50 mA typ.	
48 Vin;	dual output models:	65 mA typ.	
Surge voltage (100 msec. max.)	12 V models:	25 V max.	
	24 V models:	50 V max.	
	48 V models:	100 V max.	
Reflected input ripple current	12 V models:	50 mA typ.	
	24 V models:	30 mA typ.	
	48 V models:	20 mA typ.	
Conducted noise (input)	EN 55022 level A, FCC part 15, level A		
Start-up voltage / under voltage shut down	12 V models:	9.0 VDC max. / 8.3 VDC typ.	
	24 V models:	18 VDC max. / 16.5 VDC typ.	
	48 V models:	36 VDC / 33 VDC typ.	
Recommended input fuse (slow blow)	12 V models:	8000 mA	
	24 V models:	4000 mA	
	48 V models:	2000 mA	

### Output Specifications

Voltage set accuracy	±1.0 %	
Output voltage adjustment range	24 VDC models:	+20 / -10 %
	other models:	±10 % with external resistor (see page 3)
Regulation	- Input variation Vin min. to Vin max.	0.5 % max.
	- Load variation single output models (0 – 100 %):	0.5 % max.
	dual output models balanced load (10 – 100 %):	1.0 % max.
Minimum load	single output models:	0 %
	dual output models:	10 % of rated max current (operation at lower load condition will not damage the converters. However, they may not meet all listed specifications)
Temperature coefficient	±0.02 %/K	
Ripple and noise (20 MHz Bandwidth) with external capacitors 1 µF M/C 10 µF T/C	3.3 & 5.0 VDC models:	100 mVpk-pk. typ.
	other models:	150 mVpk-pk typ.
Transient response (25 % load step change)	250 µs typ.	
Output current limitation	110 % – 150 % of Iout max.	
Short circuit protection	24 VDC models:	0.3 Hz. typ.
	other models:	hiccup mode 1.5 Hz, automatic recovery
Capacitive load	3.3 VDC models:	21'000 µF max.
	5.0 VDC models:	13'600 µF max.
	12.0 VDC models:	2'400 µF max.
	15.0 VDC models:	1'500 µF max.
	24.0 VDC models:	600 µF max.
	±12.0 VDC models:	1'200 µF max.
±15.0 VDC models:	750 µF max.	

All specifications valid at nominal input voltage, full load and +25°C after warm-up time unless otherwise stated.

**General Specifications**

Temperature ranges	– Operating (natural convection cooling 20 LFM) – Case temperature – Storage	–40°C to +80°C (see load derating) +105°C max. –50°C to +125°C
Load derating (natural convection cooling 20 LFM)	– without heatsink – with heatsink	3.3 VDC models: 2.5 %/K above 66°C other single output models: 1.6 %/K above 46°C dual output models: 1.5 %/K above 40°C 3.3 VDC models: 3.1 %/K above 73°C other single output models: 2.0 %/K above 57°C dual output models: 1.9 %/K above 52°C
Humidity (non condensing)		95 % rel H max.
Reliability, calculated MTBF (MIL-HDBK-217F, at +25°C, ground benign)		328'000 h
Isolation voltage (60 sec.)	– Input/Output	1500 VDC
Isolation capacitance	– Input/Output	1500 pF typ.
Isolation resistance	– Input/Output	>1000 Mohm
Switching frequency (fixed)		24 VDC models: 285 kHz typ. other models: 320 kHz typ. (pulse width modulation PWM)
Altitude during operation		5'000 m max. (16'400 ft) approved
Safety standards (designed to meet)		UL/cUL 60950-1, IEC/EN 60950-1
Safety approvals	– CB test certificate according IEC 60950-1 – CSA certificate (UL/cUL 60950-1, 2nd edition)	<a href="http://www.tracopower.com/products/ten40n-cb.pdf">www.tracopower.com/products/ten40n-cb.pdf</a> <a href="http://www.tracopower.com/products/ten40n-csa.pdf">www.tracopower.com/products/ten40n-csa.pdf</a>
Remote On/Off	– On: – Off: – Off idle current:	3.5 to 12 VDC or open circuit. 0 to +1.2 VDC or short circuit pin 3 and pin 2 2.5 mA max.

**Physical Specifications**

Casing material		aluminum
Potting material		epoxy (UL 94V-0 rated)
Weight		30 g (1.05 oz)
Soldering temperature		max. 260°C / 10 sec.
Environmental compliance	– Reach – RoHS	<a href="http://www.tracopower.com/products/ten40n-reach.pdf">www.tracopower.com/products/ten40n-reach.pdf</a> RoHS directive 2011/65/EU

**Application note:** [www.tracopower.com/products/ten40n-application.pdf](http://www.tracopower.com/products/ten40n-application.pdf)

**Output Voltage Adjustment**

**Trim up**

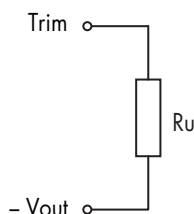

**Ru [kohm]\***

output	3.3V	5V	12V	15V
+5%	7.32	4.64	42.2	48.7
+10%	0.47	0.59	3.01	3.24

**Trim down**

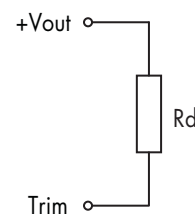

**Rd [kohm]\***

output	3.3V	5V	12V	15V
-5%	8.06	5.62	46.4	64.9
-10%	0.34	0.68	1.18	5.23

\*approximate values

All specifications valid at nominal input voltage, full load and +25°C after warm-up time unless otherwise stated.

**Outline Dimensions**

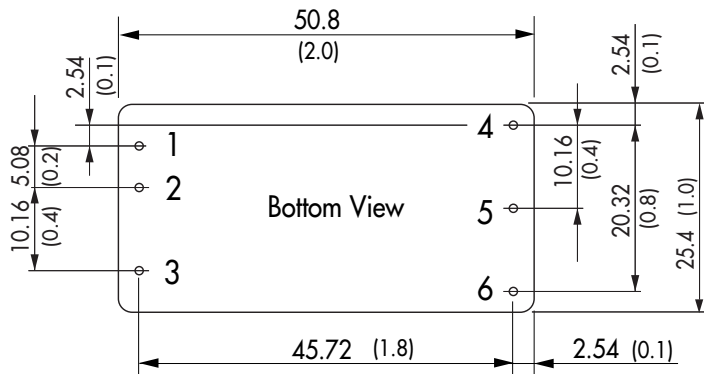

Pin-Out		
Pin	Single	Dual
1	+Vin (Vcc)	+Vin (Vcc)
2	-Vin (GND)	-Vin (GND)
3	Remote On/Off	
4	+Vout	+Vout
5	-Vout	Common
6	Trim	-Vout

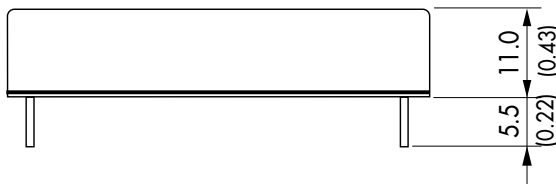

Dimensions in [mm], ( ) = Inch  
 Pin diameter: 1.0 ±0.05 (0.04 ±0.002)  
 Pin pitch tolerance: ±0.13 (±0.005)  
 Case tolerances: ±0.25 (±0.01)

**Heat-sink TEN-HS4 (optional)**

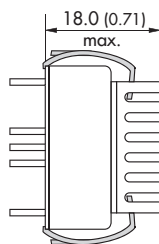
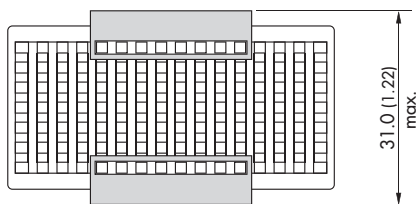
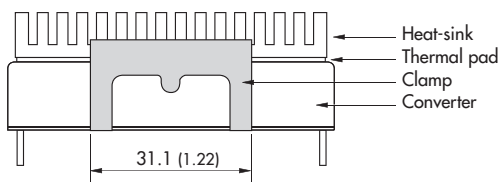

**Order code: TEN-HS4**

(cont.: heat-sink, thermal pad, 2 clamps)

**Material:** Aluminum

**Finish:** Anodic treatment (black)

**Weight:** 9 g (0.32oz) without converter

Thermal impedance after assembling: 10 K/W

**Note:**

Before attaching the heatsink, the product label on converter has to be removed for optimal performance.

For volume orders we can supply the converters with heatsink already mounted. Please contact us for a relative quotation.