

699 series



features



- Ø12.7mm mounting
- Product will operate over a wide input voltage range
- Black anodised aluminium housing, sealed to IP67
- Colour diffused lens
- Fully internally potted to resist shock and vibration
- True bi-polar product for low voltage DC applications
- Other voltages including DC options are available
- Pack Quantity = 10 Pieces

specifications

Typical characteristics (Ta = 25°C)

Part Number	Colour	Voltage Vac/dc	Current DC (mA)	Luminous Intensity (mcd)	Wave Length (nm)	Operating Temp. (°C)	Storage Temp. (°C)	De-rating Graphs
699-501-75	Red	110 Vac	6	600	630	-40 - +80	-40 - +100	D
699-521-75	Yellow	110 Vac	6	600	585	-40 - +80	-40 - +100	D
699-532-75	Green	110 Vac	6	2300	515	-40 - +75	-40 - +100	F
699-930-75	Blue	110 Vac	6	9870	465	-30 - +85	-40 - +100	U
699-997-75	White	110 Vac	6	27000	* See below	-30 - +85	-40 - +100	I
699-501-63	Red	12-28	6-16	600	630	-40 - +80	-40 - +100	D
699-521-63	Yellow	12-28	6-16	600	585	-40 - +80	-40 - +100	D
699-532-63	Green	12-28	6-16	2300	515	-40 - +75	-40 - +100	F
699-930-63	Blue	12-28	6-16	9870	465	-30 - +85	-40 - +100	U
699-997-63	White	12-28	6-16	27000	* See below	-30 - +85	-40 - +100	I

997F-C	*Typical emission colour White			
x	0.31	-	-	-
y	0.32	-	-	-

^ = Voltage for 20mA product is Vf at 20mA, not Vopr

- Products must be de-rated according to the de-rating information. Each de-rating graph refers to specific LEDs. Please refer to graphs on page 3.

- Luminous intensity is measured at 20mA on a discrete LED unless otherwise stated.

- Intensities (lv) and colour shades of white (x, y co-ordinates) may vary between LEDs within a batch

to order

to order please contact us on: t: +44 (0)1229 582 430

f: +44 (0)1229 585 155 e: sales@marl.co.uk w: www.leds.co.uk

© marl international limited technical documentation has been designed by marl international limited for the intention of providing information, which must not be copied or released to a third party without prior written consent from marl international limited. the information provided does not constitute part of any order or contract and should not be regarded as a representation relating to either products or service. no responsibility can be assumed for inaccuracies or printing errors. marl international limited reserve the right to alter without notice the specification or any conditions of supply for product or service.



BS EN ISO 9001:2008 approved manufacturer

high performance panel lamps

699 series



technical data

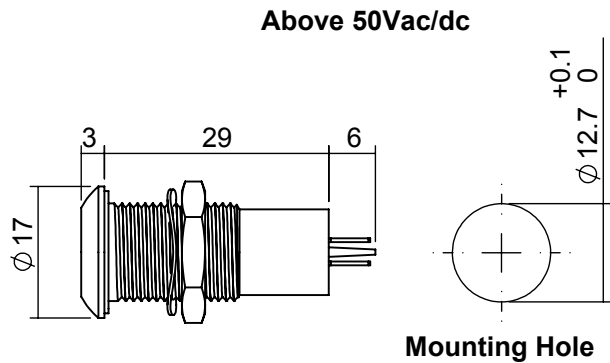
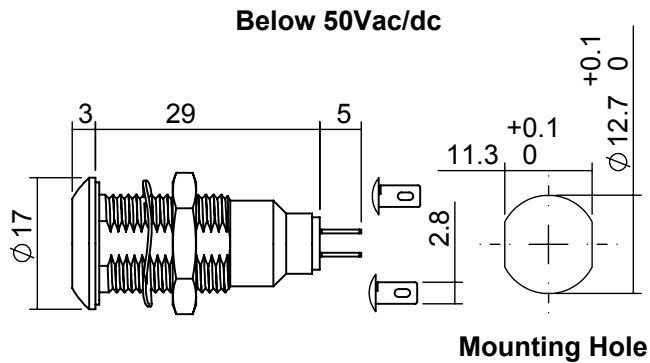

Dimensions in mm (typical)
Not to scale

Anode termination denoted by red indicator
Mounting hole to be clean and burr free

housing material

push on connectors

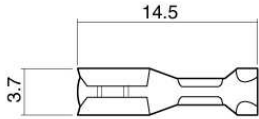
Body Nut Panel Seal Fresnel Lens Encapsulation Lock Washer Termination Header	Aluminium Grade 6063 black anodised Stainless Steel Grade 303 Viton Polycarbonate PC5430 Zinc Plated Steel Copper with Silver Flash Finish Nylon 6 A82	 <p>925-000-00 is brass tin plated - for use with 699 series lamps Dimensions in mm (typical). Not to scale.</p>
--	---	---

technical characteristics

Series	Max. Power Dissipation	Max. Reverse Voltage	Panel Cutout	Nut Mounting Torque	Min. Mounting Centres	Max. Panel Thickness
699	825	-	12.7	1.0	26.0	2.0 - 10.0
units	mW	Vdc	mm	Nm	mm	mm

* = Current Version ^ = Voltage Version

to order

to order please contact us on: t: +44 (0)1229 582 430 f: +44 (0)1229 585 155
e: sales@marl.co.uk w: www.leds.co.uk

© marl international limited technical documentation has been designed by marl international limited for the intention of providing information, which must not be copied or released to a third party without prior written consent from marl international limited. the information provided does not constitute part of any order or contract and should not be regarded as a representation relating to either products or service. no responsibility can be assumed for inaccuracies or printing errors. marl international limited reserve the right to alter without notice the specification or any conditions of supply for product or service.



699 series



de-rating information

Derating Graph D

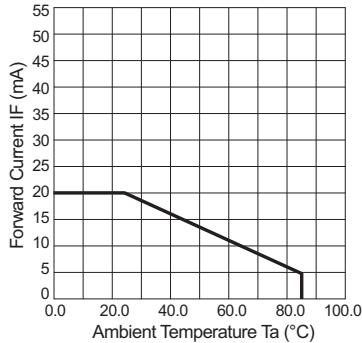

Derating Graph F

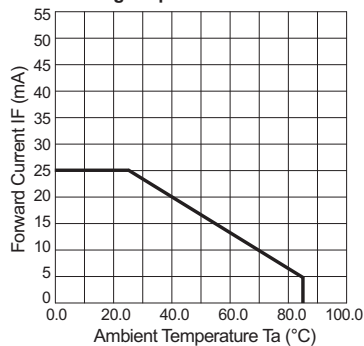

Derating Graph I

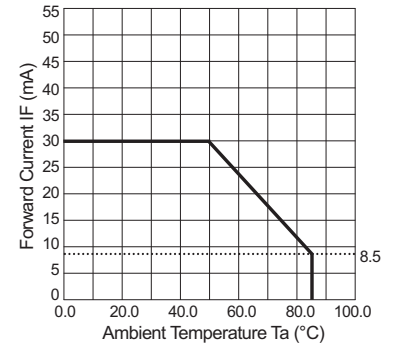

Derating Graph U

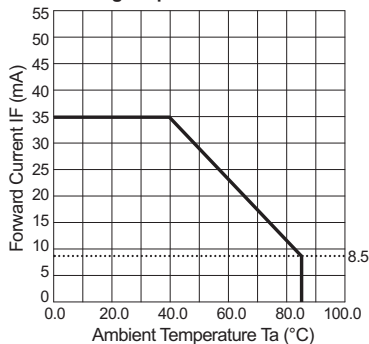

also available

Part numbers also available in the 699 series:

Part Number	Colour	Voltage Vopr
699-532-54-50	Green	32 Vdc
699-532-63-50	Green	12-28Vac/dc

The products listed here illustrate all of the options available to order. These products may have custom modifications that alter their operation beyond the generic information contained within this datasheet. Please contact sales for further information.

* = These products do not contain integral resistors

to order

to order please contact us on: t: +44 (0)1229 582 430 f: +44 (0)1229 585 155
e: sales@marl.co.uk w: www.leds.co.uk

© marl international limited technical documentation has been designed by marl international limited for the intention of providing information, which must not be copied or released to a third party without prior written consent from marl international limited. the information provided does not constitute part of any order or contract and should not be regarded as a representation relating to either products or service. no responsibility can be assumed for inaccuracies or printing errors. marl international limited reserve the right to alter without notice the specification or any conditions of supply for product or service.



699 series



design considerations

Electro-Static Discharge (ESD)

Build up of electro-static discharge occurs in many situations involving people moving and handling products. The range of possible situations is very diverse but voltage levels as high as several thousand volts can and do arise in many individual situations. When an operator charged up to these levels handles a static sensitive device, there is a very probable likelihood that the device will be irreversibly damaged. It is essential that precautions are taken at all stages during manufacture and assembly of these products. Although LEDs were never considered to be static sensitive devices, changes in manufacturing technology and materials used to produce higher intensity products over a large range of the wavelength spectrum have changed this. Marl has an approved system of ESD control from goods in, through production and into final packing and despatch. Marl recommend all users of LED based products follow the guidelines of BS 100015.

Power De-Rating

The forward voltage/ current value of an LED is dependant upon the ambient temperature of the environment in which it is operated. Therefore, care must be taken to operate the LED at the correct voltage/ current values, depending upon the ambient temperature. Consequently, a recommendation regarding operating voltages and currents is given in order to address these temperature effects. This recommendation is termed 'de-rating'. It is usual for forward voltages and currents to be specified for ambient temperature of 25°C. However, because the values of these qualities vary with temperature, please refer to the de-rating graphs for correct operation. Marl accept no liability for any product that is operated higher than the stated voltage.

to order

**to order please contact us on: t: +44 (0)1229 582 430 f: +44 (0)1229 585 155
e: sales@marl.co.uk w: www.leds.co.uk**

© marl international limited technical documentation has been designed by marl international limited for the intention of providing information, which must not be copied or released to a third party without prior written consent from marl international limited. the information provided does not constitute part of any order or contract and should not be regarded as a representation relating to either products or service. no responsibility can be assumed for inaccuracies or printing errors. marl international limited reserve the right to alter without notice the specification or any conditions of supply for product or service.

