

# HTG3500 Series – Relative Humidity and Temperature Module

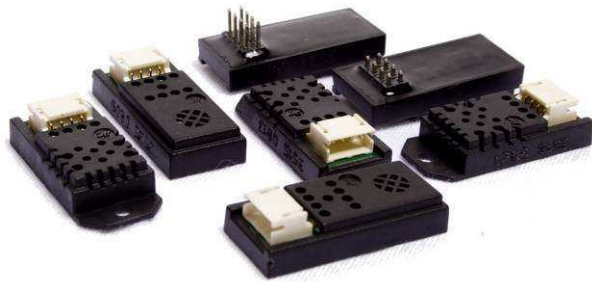

- Suitable for small bulk assembly
- Product free from Lead, Cr (6+), Cd and Hg. Compliant with RoHS
- Full interchangeability. Better than +/-3%RH and +/-0.25°C
- Humidity calibrated within +/- 3% RH @ 55% RH
- Temperature measurement through NTC direct output



## DESCRIPTION

Based on the rugged MEAS-France humidity sensor, the HTG3500 Series are dedicated humidity and temperature plug and play transducers designed for OEM applications where reliable and accurate measurements are needed. Direct interface with a micro-controller is made possible with the modules humidity linear voltage and direct NTC outputs. The HTG3500 Series are designed for high volume and demanding applications where power consumption is critical.

## FEATURES

- Demonstrated reliability and long term stability
- Reliability not affected by repeated condensation

## APPLICATIONS

- Automotive
- Home Appliance
- Printers

...

## PERFORMANCE SPECS

### MAXIMUM RATINGS

Ratings	Symbol	Value	Unit
Storage Temperature	T <sub>stg</sub>	-40 to +125	°C
Supply Voltage (Peak)	V <sub>cc</sub>	20	V <sub>dc</sub>
Humidity Operating Range	RH	0 to 100	%RH
Temperature Operating Range	T <sub>a</sub>	-40 to +110	°C
Maximum Output Current (Peak)	I <sub>peak</sub>	3	mA
Maximum Power	P <sub>d</sub>	10	mW

**Peak conditions:** less than 10% of the operating time.

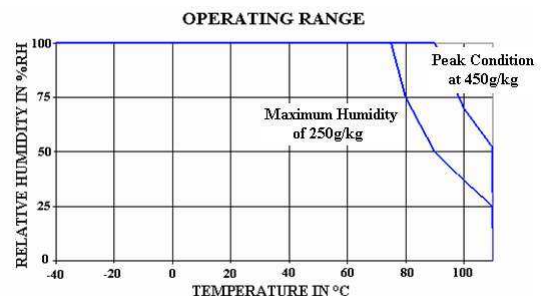

## HTG3500 Series - Relative Humidity and Temperature Module

### ELECTRICAL CHARACTERISTICS

(@T=23°C, R<sub>L</sub>>1MΩ unless otherwise noted)

Humidity Characteristics	Symbol	Min	Typ	Max	Unit
Humidity Measuring Range	RH	0		100	%RH
Relative Humidity Accuracy (10% to 95%RH)			±3	±5	%RH
Temperature coefficient (10°C to 50°C)	T <sub>cc</sub>		-0.05	-0.1	%RH/°C
Recovery time after 150 hours of condensation	t		10		s
Humidity hysteresis			+/-1		%RH
Output impedance	Z			50	Ω
Sink current capability (R <sub>L_Min</sub> = 8 kOhms) <sup>(1)</sup>	I			1	mA
Warm up time (90% of signal)	t <sub>w</sub>		150		ms
Time Constant (at 63% of signal) 33%RH to 75%RH <sup>(2)</sup>	τ		5	10	s

(1) Conditions of sink current: V<sub>out</sub> + 0.054V (3%RH) at V<sub>out</sub> = 0.600 V (V<sub>out</sub> min)

(2) At 1m/s air flow

Temperature Characteristics*	Symbol	Min	Typ	Max	Unit
Nominal resistance @ 25°C	R	9.9	10	10.1	kΩ
Beta value : B25/50	B	3346	3380	3414	K
Temperature measuring range	T <sub>a</sub>	-40		85	°C
Nominal Resistance Tolerance at 25°C	R <sub>n</sub>		1		%
B value tolerance	B		1		%
Time Constant	τ		10		s

\* Except for low temperatures

### POWER SUPPLY OPTION OF HTG3500 SERIES AT 3.3V<sub>DC</sub> OR AT 5V<sub>DC</sub>

At 3.3V<sub>DC</sub> or at 5V<sub>DC</sub> power supply, there is no measurable impact of type of powering on temperature and RH accuracy.

### NOMENCLATURE

#### HTG3XYZ yyy

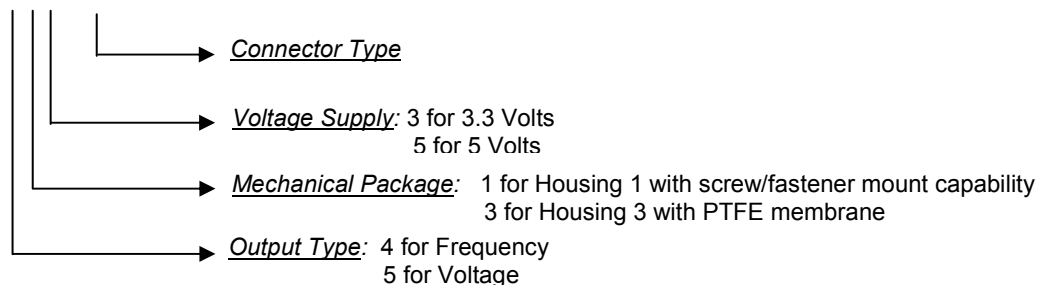

# HTG3500 Series - Relative Humidity and Temperature Module

## SPECIFIC ELECTRICAL AND METROLOGICAL CHARACTERISTICS

- HTG35Y3

Characteristics	Symbol	Min	Typ	Max	Unit
Voltage Supply <sup>(1) (2)</sup>	V <sub>cc</sub>	3	3.3	3.46	V <sub>dc</sub>
Nominal Output @55%RH	V <sub>out</sub>	1.462	1.515	1.568	V
Humidity Average Sensitivity	ΔmV/RH	-	+18	-	mV/%RH
Current consumption	I <sub>cc</sub>	-	1.0	1.2	mA dc

- (1) Module is ratiometric to voltage supply
- (2) Maximum power supply ramp up time to VCC should be less than 20ms

- HTG35Y5

Characteristics	Symbol	Min	Typ	Max	Unit
Voltage Supply <sup>(1) (2)</sup>	V <sub>cc</sub>	4.75	5	5.25	V <sub>dc</sub>
Nominal Output @55%RH	V <sub>out</sub>	2.401	2.480	2.559	V
Humidity Average Sensitivity	ΔmV/RH	-	+26	-	mV/%RH
Current consumption	I <sub>cc</sub>	-	1.2	1.5	mA dc

- (1) Module is ratiometric to voltage supply
- (2) Maximum power supply ramp up time to VCC should be less than 20ms

## TYPICAL PERFORMANCE CURVES

### HUMIDITY SENSOR

- Humidity Look-up Tables

HTG35Y5 Modeled Voltage Output				HTG35Y3 Modeled Voltage Output			
Reference Output Values (V <sub>cc</sub> = 5V) In any power mode				Reference Output Values (V <sub>cc</sub> = 3.3V) In any power mode			
RH (%)	V <sub>out</sub> (mV)	RH (%)	V <sub>out</sub> (mV)	RH (%)	V <sub>out</sub> (mV)	RH (%)	V <sub>out</sub> (mV)
10	1235	55	2480	10	690	55	1515
15	1390	60	2605	15	795	60	1595
20	1540	65	2730	20	895	65	1680
25	1685	70	2860	25	990	70	1765
30	1825	75	2990	30	1080	75	1850
35	1960	80	3125	35	1170	80	1940
40	2090	85	3260	40	1255	85	2030
45	2220	90	3400	45	1345	90	2120
50	2350	95	3530	50	1430	95	2205

#### POLYNOMIAL EQUATIONS

$$V_{out} = 8.43E^{-4} RH^3 - 0.1485 RH^2 + 34.16 RH + 909$$

$$RH = -1.564E^{-9} V_{out}^3 + 1.205E^{-5} V_{out}^2 + 8.22E^{-3} V_{out} - 15.6$$

with V<sub>out</sub> in mV and RH in %

#### LINEAR EQUATIONS

$$V_{out} = 26.23 RH + 1032$$

$$RH = 0.03812 V_{out} - 39.36$$

with V<sub>out</sub> in mV and RH in %

#### POLYNOMIAL EQUATIONS

$$V_{out} = 5.57E^{-4} RH^3 - 9.81E^{-2} RH^2 + 22.55 RH + 477.2$$

$$RH = -5.38E^{-9} V_{out}^3 + 2.55E^{-5} V_{out}^2 + 1.9E^{-2} V_{out} - 13.5$$

with V<sub>out</sub> in mV and RH in %

#### LINEAR EQUATIONS

$$V_{out} = 17.52 RH + 544.1$$

$$RH = 0.057 V_{out} - 31.0$$

with V<sub>out</sub> in mV and RH in %

## HTG3500 Series - Relative Humidity and Temperature Module

- Humidity error budget conditions at 23°C

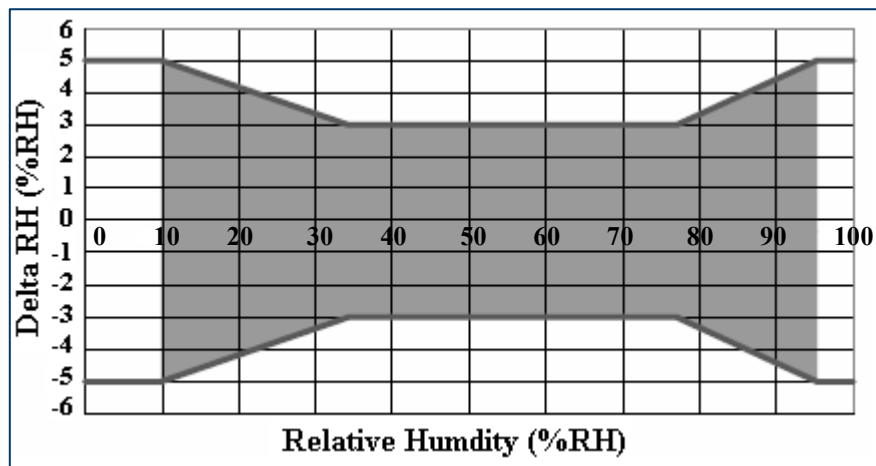

HTG3500 series modules are specified for maximum accuracy measurements within 10 to 95 %RH.

Excursion out of this range (< 10% or > 95% RH, including condensation) does not affect the reliability of HTG3500 series characteristics.

### TEMPERATURE SENSOR

- Typical temperature output

Depending on the needed temperature measurement range and associated accuracy, we suggest two methods to access to the NTC resistance values.

$$R_T = R_N \times e^{\beta \left( \frac{1}{T} - \frac{1}{T_N} \right)}$$

$R_T$	NTC resistance in $\Omega$ at temperature T in K
$R_N$	NTC resistance in $\Omega$ at rated temperature T in K
T, $T_N$	Temperature in K
$\beta$	Beta value, material specific constant of NTC
e	Base of natural logarithm (e=2.71828)

① The exponential relation only roughly describes the actual characteristic of an NTC thermistor can, however, as the material parameter  $\beta$  in reality also depend on temperature. So this approach is suitable for describing a restricted range around the rated temperature or resistance with sufficient accuracy.

② For practical applications, a more precise description of the real R/T curve may be required. Either more complicated approaches (e.g. the Steinhart-Hart equation) are used or the resistance/temperature relation as given in tabulation form. The below table has been experimentally determined with utmost accuracy for temperature increments of 1 degree.

Actual values may also be influenced by inherent self-heating properties of NTCs. Please refer to MEAS-France Application Note HPC106 "Low power NTC measurement".

# HTG3500 Series - Relative Humidity and Temperature Module

- Temperature Look-up Table

Temp (°C)	R (Ω)
-40	195652
-39	184917
-38	174845
-37	165391
-36	156513
-35	148171
-34	140330
-33	132958
-32	126022
-31	119494
-30	113347
-29	107565
-28	102116
-27	96978
-26	92132
-25	87559
-24	83242
-23	79166
-22	75316
-21	71677
-20	68237
-19	64991
-18	61919
-17	59011
-16	56258
-15	53650
-14	51178
-13	48835
-12	46613
-11	44506
-10	42506
-9	40600
-8	38791
-7	37073
-6	35442
-5	33892
-4	32420
-3	31020
-2	29689
-1	28423

Temp (°C)	R (Ω)
0	27219
1	26076
2	24988
3	23951
4	22963
5	22021
6	21123
7	20267
8	19450
9	18670
10	17926
11	17214
12	16534
13	15886
14	15266
15	14674
16	14108
17	13566
18	13049
19	12554
20	12081
21	11628
22	11195
23	10780
24	10382
25	10000
26	9634
27	9284
28	8947
29	8624
30	8315
31	8018
32	7734
33	7461
34	7199
35	6948
36	6707
37	6475
38	6253
39	6039

Temp (°C)	R (Ω)
40	5834
41	5636
42	5445
43	5262
44	5086
45	4917
46	4754
47	4597
48	4446
49	4301
50	4161
51	4026
52	3896
53	3771
54	3651
55	3535
56	3423
57	3315
58	3211
59	3111
60	3014
61	2922
62	2834
63	2748
64	2666
65	2586
66	2509
67	2435
68	2364
69	2294
70	2228
71	2163
72	2100
73	2040
74	1981
75	1925
76	1870
77	1817
78	1766
79	1716

Temp (°C)	R (Ω)
80	1669
81	1622
82	1578
83	1535
84	1493
85	1452
86	1413
87	1375
88	1338
89	1303
90	1268
91	1234
92	1202
93	1170
94	1139
95	1110
96	1081
97	1053
98	1026
99	999
100	974
101	949
102	925
103	902
104	880
105	858
106	837
107	816
108	796
109	777
110	758

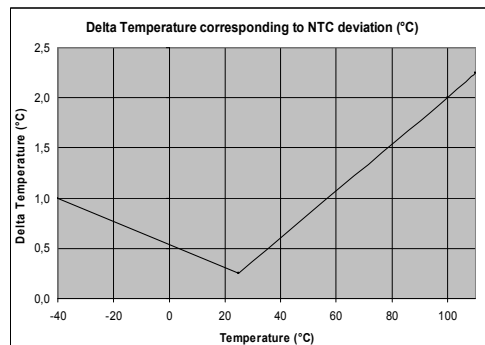

0.1°C tolerance on Resistance Measurement

## HTG3500 Series - Relative Humidity and Temperature Module

- Steinhart-Hart coefficients

According to the equation below, the Steinhart-Hart coefficients for the operating temperature range for HTG3500 products thermistor are:

$$\frac{1}{T} = a + b * \ln(R) + C * \ln(R) * \ln(R) * \ln(R)$$

R NTC resistance in  $\Omega$  at temperature T in K  
 T Temperature in K  
 a Constant value (a= 8.61393E-04)  
 b Constant value (b= 2.56377E-04)  
 c Constant value (c= 1.68055E-07)

- Temperature Interface circuit

Concerning the temperature sensor of the HTG3500 Series products, the following measuring method described below is based on a voltage bridge divider circuit. It uses only one resistor component (Rbatch) at 1% to design HTM2500 temperature sensor interfacing circuit.

Rbatch is chosen to be equal to NTC @25°C to get:  $V_{out} = V_{cc}/2$  @25°C.

The proposal method connects Rbatch to Vcc (5Vdc) and NTC to Ground. It leads to a negative slope characteristic (Pull-Up Configuration).

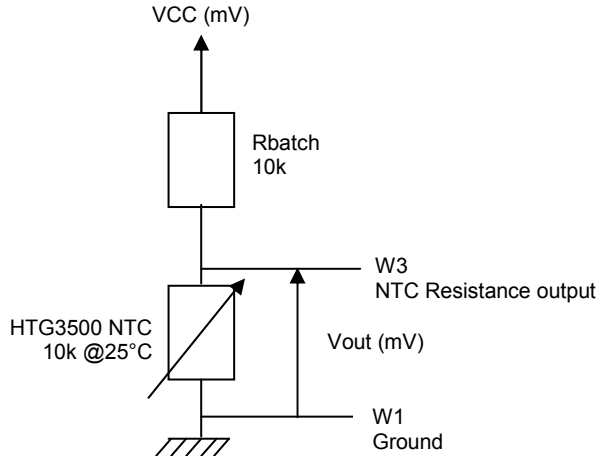

$$V_{OUT}(mV) = \frac{V_{cc}(mV) * NTC_{HTG3500}(\Omega)}{R_{batch}(\Omega) + NTC_{HTG3500}(\Omega)}$$

Temperature (°C)	Resistance ( $\Omega$ )	Pull-Up Configuration Vout (mV)
-40	195652	4757
-30	113347	4595
-20	68237	4361
-10	42506	4048
0	27219	3657
10	17926	3210
20	12081	2736
25	10000	2500
30	8315	2270
40	5834	1842
50	4161	1469
60	3014	1158
70	2228	911
80	1669	665
90	1268	563
100	974	444
110	758	352

# HTG3500 Series - Relative Humidity and Temperature Module

## CONNECTING AND MECHANICAL CHARACTERISTICS

### CONNECTING CHARACTERISTICS

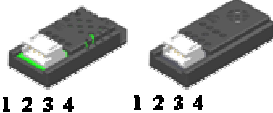
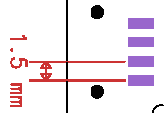
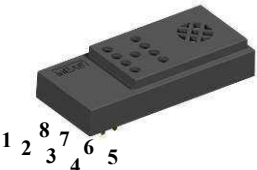
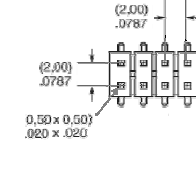
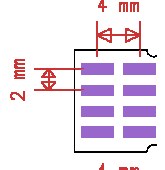
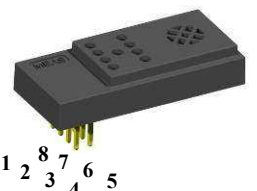
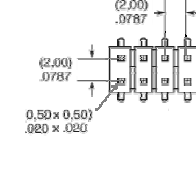
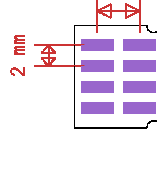
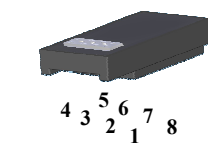
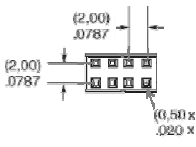
Connector Type	Symbol	Overview	Housing	Connector Pitch	Connector Footprint	Mating Connector*
Side Connector	CH		1 & 3	-		JST ZHR-4
Short Male Connector <sup>(1) (3)</sup> (1.65 mm – 0.065 in long)	PVBS		3			Samtec CLT 104 Series
Long Male Connector <sup>(2) (3)</sup> (4.27 mm – 0.198 in long)	PVBL		3			Direct Soldering (through hole)
Female Connector <sup>(1) (3)</sup>	CFB		3		-	Samtec TMM 104-05-D

\* For alternate connector type, please contact factory.

- (1) Connector should undergo vibration test before validation.  
A second fixing point add double-sided adhesive tape (ref: 3M – 5925F).
- (2) For board-to-board mounting, we suggest wave soldering.
- (3) Pins are connected by twos.

### Pin Out Assignment

N°	Function
1/8	Ground
2/7	Vcc – Voltage Supply
3/6	NTC – Temperature
4/5	Vout – Humidity

### WIRING CHARACTERISTICS

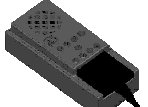
	Overview	Housing	More information
With wires		1	Wiring cable length*: TBD Wiring cable type*: AWG 24 to 30
		3	Wiring cable length*: TBD Wiring cable type*: AWG 24 to 30

### Pin Out Assignment (with wires)

Colour	Function
Black	Ground
Red	Vcc – Voltage Supply
Green	NTC – Temperature
Yellow	Vout – Humidity

\* On request, please contact factory.

# HTG3500 Series - Relative Humidity and Temperature Module

## MECHANICAL CHARACTERISTICS: HTG3500 SERIES PACKAGE OUTLINE

### Housing 1 : HTG3X1Z (with screw/fastener capability)

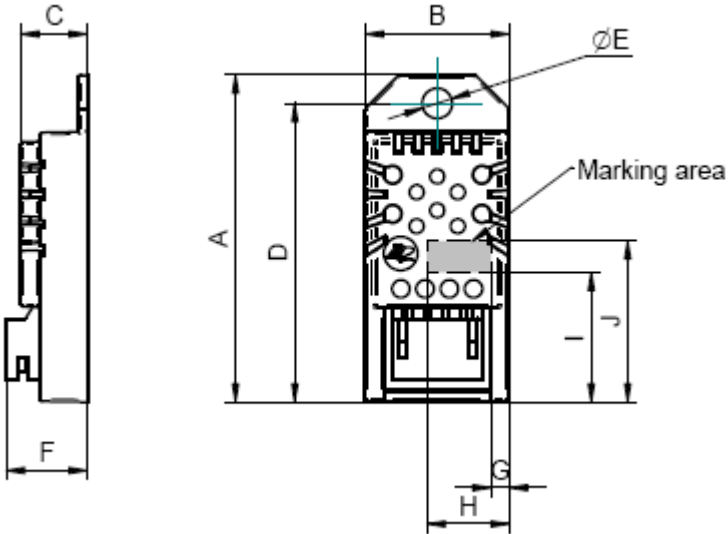

#### Package Outline With CH connector

Dim	Typ (mm)
A	27 ± 0.25
B	11.9 ± 0.2
C	5.7 ± 0.5
D	24.65 ± 0.25
E	Ø2.5 ± 0.2
F	6.7 ± 0.3
G	1.5 ± 0.5
H	6.8 ± 0.5
I	10.7 ± 0.5
J	13.3 ± 0.5

Color : Black  
Weight : 1.5g

Housing 1 can be fixed with a M2 screw. The recommended maximum mounting torque is 0.22 Nm.

### Housing 3 : HTG3X3Z (with PTFE membrane)

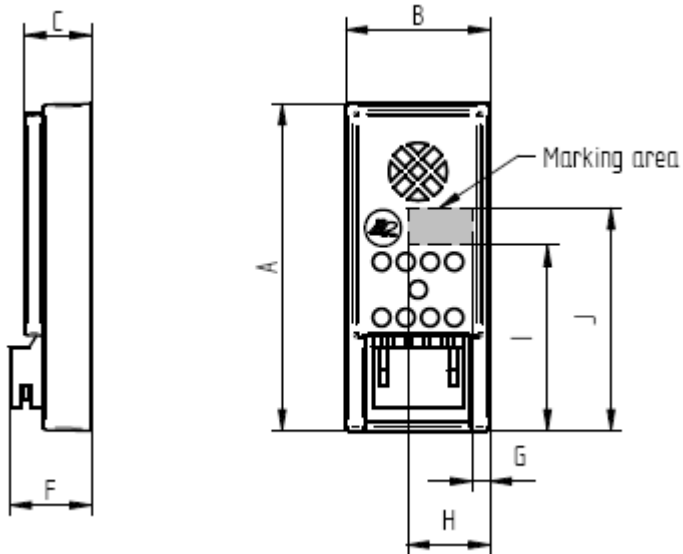

#### Package Outline with CH connector

Dim	Typ (mm)
A	27 ± 0.25
B	11.9 ± 0.2
C	5.7 ± 0.5
F	6.7 ± 0.3
I	1.5 ± 0.5
J	6.8 ± 0.5
K	15.3 ± 0.5
L	18.4 ± 0.5

Color : Black  
Weight : 1.8g



## HTG3500 Series - Relative Humidity and Temperature Module

	<p align="center"><b>Package Outline with PVBS connector</b> (1.65 mm – 0.065 in long)</p> <table border="1"> <thead> <tr> <th>Dim</th> <th>Typ (mm)</th> <th>Dim</th> <th>Typ (mm)</th> </tr> </thead> <tbody> <tr> <td>A</td> <td>27 ± 0.25</td> <td>G</td> <td>1 ± 0.25</td> </tr> <tr> <td>B</td> <td>11.9 ± 0.2</td> <td>H</td> <td>3° ± 1°</td> </tr> <tr> <td>C</td> <td>5.7 ± 0.5</td> <td>I</td> <td>1.5 ± 0.5</td> </tr> <tr> <td>D</td> <td>2.95 ± 0.3</td> <td>J</td> <td>6.8 ± 0.5</td> </tr> <tr> <td>E</td> <td>4.32 ± 0.3</td> <td>K</td> <td>15.3 ± 0.5</td> </tr> <tr> <td>F</td> <td>8.2 ± 0.5</td> <td>L</td> <td>18.4 ± 0.5</td> </tr> </tbody> </table> <p align="center">Color : Black Weight : 1.8g</p>	Dim	Typ (mm)	Dim	Typ (mm)	A	27 ± 0.25	G	1 ± 0.25	B	11.9 ± 0.2	H	3° ± 1°	C	5.7 ± 0.5	I	1.5 ± 0.5	D	2.95 ± 0.3	J	6.8 ± 0.5	E	4.32 ± 0.3	K	15.3 ± 0.5	F	8.2 ± 0.5	L	18.4 ± 0.5
Dim	Typ (mm)	Dim	Typ (mm)																										
A	27 ± 0.25	G	1 ± 0.25																										
B	11.9 ± 0.2	H	3° ± 1°																										
C	5.7 ± 0.5	I	1.5 ± 0.5																										
D	2.95 ± 0.3	J	6.8 ± 0.5																										
E	4.32 ± 0.3	K	15.3 ± 0.5																										
F	8.2 ± 0.5	L	18.4 ± 0.5																										
	<p align="center"><b>Package Outline with PVBL connector</b> (4.27 mm – 0.198 in long)</p> <table border="1"> <thead> <tr> <th>Dim</th> <th>Typ (mm)</th> <th>Dim</th> <th>Typ (mm)</th> </tr> </thead> <tbody> <tr> <td>A</td> <td>27 ± 0.25</td> <td>G</td> <td>1 ± 0.25</td> </tr> <tr> <td>B</td> <td>11.9 ± 0.2</td> <td>H</td> <td>3° ± 1°</td> </tr> <tr> <td>C</td> <td>5.7 ± 0.5</td> <td>I</td> <td>1.5 ± 0.5</td> </tr> <tr> <td>D</td> <td>2.95 ± 0.3</td> <td>J</td> <td>6.8 ± 0.5</td> </tr> <tr> <td>E</td> <td>4.32 ± 0.3</td> <td>K</td> <td>15.3 ± 0.5</td> </tr> <tr> <td>F</td> <td>10.8 ± 0.5</td> <td>L</td> <td>18.4 ± 0.5</td> </tr> </tbody> </table> <p align="center">Color : Black Weight : 1.8g</p>	Dim	Typ (mm)	Dim	Typ (mm)	A	27 ± 0.25	G	1 ± 0.25	B	11.9 ± 0.2	H	3° ± 1°	C	5.7 ± 0.5	I	1.5 ± 0.5	D	2.95 ± 0.3	J	6.8 ± 0.5	E	4.32 ± 0.3	K	15.3 ± 0.5	F	10.8 ± 0.5	L	18.4 ± 0.5
Dim	Typ (mm)	Dim	Typ (mm)																										
A	27 ± 0.25	G	1 ± 0.25																										
B	11.9 ± 0.2	H	3° ± 1°																										
C	5.7 ± 0.5	I	1.5 ± 0.5																										
D	2.95 ± 0.3	J	6.8 ± 0.5																										
E	4.32 ± 0.3	K	15.3 ± 0.5																										
F	10.8 ± 0.5	L	18.4 ± 0.5																										
	<p align="center"><b>Package Outline with CFB connector</b></p> <table border="1"> <thead> <tr> <th>Dim</th> <th>Typ (mm)</th> <th>Dim</th> <th>Typ (mm)</th> </tr> </thead> <tbody> <tr> <td>A</td> <td>27 ± 0.25</td> <td>F</td> <td>0.5 ± 0.25</td> </tr> <tr> <td>B</td> <td>11.9 ± 0.2</td> <td>G</td> <td>1.5 ± 0.25</td> </tr> <tr> <td>C</td> <td>5.7 ± 0.5</td> <td>H</td> <td>6.8 ± 0.5</td> </tr> <tr> <td>D</td> <td>2.95 ± 0.3</td> <td>I</td> <td>15.3 ± 0.5</td> </tr> <tr> <td>E</td> <td>4.32 ± 0.3</td> <td>J</td> <td>18.4 ± 0.5</td> </tr> </tbody> </table> <p align="center">Color : Black Weight : 1.8g</p>	Dim	Typ (mm)	Dim	Typ (mm)	A	27 ± 0.25	F	0.5 ± 0.25	B	11.9 ± 0.2	G	1.5 ± 0.25	C	5.7 ± 0.5	H	6.8 ± 0.5	D	2.95 ± 0.3	I	15.3 ± 0.5	E	4.32 ± 0.3	J	18.4 ± 0.5				
Dim	Typ (mm)	Dim	Typ (mm)																										
A	27 ± 0.25	F	0.5 ± 0.25																										
B	11.9 ± 0.2	G	1.5 ± 0.25																										
C	5.7 ± 0.5	H	6.8 ± 0.5																										
D	2.95 ± 0.3	I	15.3 ± 0.5																										
E	4.32 ± 0.3	J	18.4 ± 0.5																										

Double coated adhesive tape could be used on potted area for housings 1 and 3 (ref: 3M – 5925F) to fix parts.

### RESISTANCE TO PHYSICAL AND CHEMICAL STRESSES

HTG3500 Series have passed through qualification processes of MEAS-France including vibration, shock, storage, high temperature and humidity, ESD.

HTG3500 Series contain circuits to protect its inputs and outputs against Electrostatic discharges (ESD) up to ±15kV, air discharge.

HTG3500 Series are protected against EMC interferences.

## HTG3500 Series - Relative Humidity and Temperature Module

HTG3500 Series are protected against reverse polarity.

Additional tests under harsh chemical conditions demonstrate good operation in presence of salt atmosphere, SO<sub>2</sub> (0.5%), H<sub>2</sub>S (0.5%), O<sub>3</sub>, NO<sub>x</sub>, NO, CO, CO<sub>2</sub>, Softener, Soap, Toluene, acids (H<sub>2</sub>SO<sub>4</sub>, HNO<sub>3</sub>, HCl), HMDS, Insecticide, Cigarette smoke, a non-exhaustive list.

HTG3500 Series are not light sensitive.

### ORDERING INFORMATION

#### HTG3XYZ yyy

X		Y		Z		yyy			
Output Voltage		Housing		Voltage Supply		Connector Type			
4	5	1	3	3	5	CH	PVBS	PVBL	CFB
Frequency	Voltage	with screw/fastener	with PTFE membrane	3.3V	5V				

Product	Order Reference	Product	Order Reference
HTG3513CH	HPP815A533	HTG3515CH	HPP815A535
HTG3533CH	HPP815F533	HTG3535CH	HPP815F535
HTG3533PVBL	HPP815H534	HTG3535PVBL	HPP815G537
HTG3533PVBS	HPP815H533	HTG3535PVBS	HPP815G536
HTG3533CFB	HPP815H536	HTG3535CFB	HPP815F534

#### Customer Service contact details

Measurement Specialties, Inc.  
105 av. du Général Eisenhower  
BP 23705 31037 TOULOUSE CEDEX 1  
FRANCE  
Tél: +33 (0) 561 194 848  
Fax: +33 (0) 561 194 553  
Sales: [humidity.sales@meas-spec.com](mailto:humidity.sales@meas-spec.com)

Revision	Comments	Who	Date
E	Nomenclature updated	D. LE GALL	September 08
F	RH LUT @3.3V updated, Steinhart-Hart equation and temperature interface circuit added, max torque for housing 1 added, marking location area and dimensions updated, resistance to physical and chemical stresses paragraph updated	D. LE GALL	June 09
G	Wiring characteristics updated and dimension C rectified	D. LE GALL	January 10
H	Package outline updated for PVBL and PVBS modules, dimensions C and D rectified for housing 3, HPP references added	D. LE GALL	December 10
I	New MEAS Template applied, updated PVBS/PVBL/CFB connector dimension definition in Mechanical Characteristics paragraph	D. LE GALL	January 12

The information in this sheet has been carefully reviewed and is believed to be accurate; however, no responsibility is assumed for inaccuracies. Furthermore, this information does not convey to the purchaser of such devices any license under the patent rights to the manufacturer. Measurement Specialties, Inc. reserves the right to make changes without further notice to any product herein. Measurement Specialties, Inc. makes no warranty, representation or guarantee regarding the suitability of its product for any particular purpose, nor does Measurement Specialties, Inc. assume any liability arising out of the application or use of any product or circuit and specifically disclaims any and all liability, including without limitation consequential or incidental damages. Typical parameters can and do vary in different applications. All operating parameters must be validated for each customer application by customer's technical experts. Measurement Specialties, Inc. does not convey any license under its patent rights nor the rights of others.