

FEATURES

- Guaranteed Output Current of 3.0A
- Fixed Output Voltage: 1.5V, 1.8V, 2.5V, 3.3V and 5.0V
- 1% initial accuracy
- Low ground current
- Over-Temperature/Over-Current Protection
- Fast transient response
- TTL/CMOS compatible enable pin → LM39301
- Error flag output - LM39301 only
- Available in TO-263 and TO-220 packages
- - 40°C to 125°C Junction Temperature Range
- Moisture Sensitivity Level 3

APPLICATION

- Battery Powered Equipments
- Motherboards and Graphic Cards
- Microprocessor Power Supplies
- Peripheral Cards
- High Efficiency Linear Regulators
- Battery Chargers

DESCRIPTION

The LM39300, LM39301 and LM39302 are 3.0A low-dropout linear voltage regulators that provide a low voltage, high-current output with a minimum of external components. The LM39300/1 offers extremely low dropout (typically 400mV at 3.0A) and low ground current (typically 36mA at 3.0A). The LM39300/1/2 is ideal for PC add-in cards that need to convert from standard 5V or 3.3V down to new, lower core voltages. A guaranteed maximum dropout voltage of 500mV over all operating conditions allows the LM39300/1/2 to provide 2.5V from a supply as low as 3V. The LM39300/1/2 also has fast transient response for heavy switching applications. The device requires only 47uF of output capacitance to maintain stability and achieve fast transient response. The LM39300/1 is fully protected with over current limiting, thermal shutdown, reversed-battery protection, reversed-leakage protection, and reversed-lead insertion. The LM39301 offers a TTL-logic compatible enable pin and an error flag that indicates under voltage and over current conditions. Offered in fixed voltages, the LM39300/1/2 comes in the TO-220 and TO-263 packages and is an ideal upgrade to older, NPN-based linear voltage regulators.

Absolute Maximum Ratings ^(Note 1)

CHARACTERISTIC	SYMBOL	MIN.	MAX.	UNIT
Supply Voltage	V _{IN}	- 0.3	+ 20	V
Enable Voltage	V _{EN}	-	+ 20	V
Output Voltage	V _{OUT}	-0.3	V _{IN} +0.3	V
Lead Temperature (Soldering, 5 sec)	T _{SOL}	-	260	°C
Storage Temperature Range	T _{STG}	-65	+ 150	°C

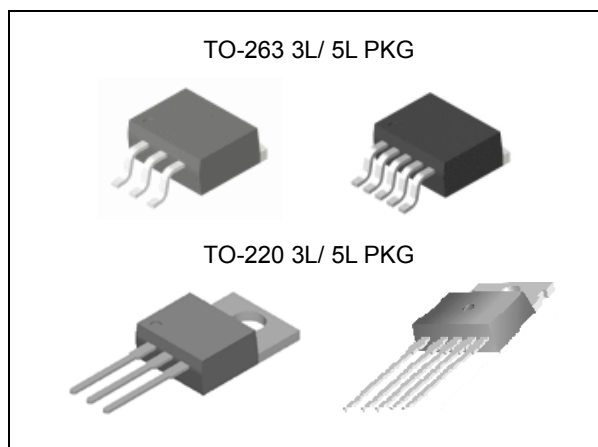

ORDERING INFORMATION

Device	Package
LM39300R-X.X	TO-263 3L
LM39300T-X.X	TO-220 3L
LM39301R-X.X	TO-263 5L
LM39301T-X.X	TO-220 5L
LM39302R-ADJ	TO-263 5L
LM39302T-ADJ	TO-220 5L

X.X = Output Voltage = 1.5, 1.8, 2.5, 3.3, 5.0

3A Low-Voltage Low-Dropout Regulator

LM39300/39301/39302

Operating Ratings (Note 2)

CHARACTERISTIC	SYMBOL	MIN.	MAX.	UNIT
Supply Voltage	V_{IN}	+ 2.25	+ 16	V
Enable Voltage	V_{EN}	+ 2.25	+ 16	V
Maximum Power Dissipation	$PD_{(max)}$	(Note 3)	(Note 3)	
Junction Temperature	T_J	-40	+ 125	°C
Package Thermal Resistance	$\theta_{JA-TO-263}$	80		°C/W
	$\theta_{JA-TO-220}$	70		°C/W

Ordering Information

V_{OUT}	Package	Order No.	Description	Supplied As	Status
1.5 V	TO-263 3L	LM39300R-1.5	3A, Fixed	Reel	Active
	TO-263 3L	LM39300GR-1.5	3A, Fixed	Reel	Obsolete
	TO-263 5L	LM39301R-1.5	3A, Fixed, Enable	Reel	Active
	TO-263 5L	LM39301GR-1.5	3A, Fixed, Enable	Reel	Obsolete
	TO-220 3L	LM39300T-1.5	3A, Fixed	Reel	Active
	TO-220 5L	LM39301T-1.5	3A, Fixed, Enable	Reel	Obsolete
1.8V	TO-263 3L	LM39300R-1.8	3A, Fixed	Reel	Active
	TO-263 3L	LM39300GR-1.8	3A, Fixed	Reel	Obsolete
	TO-263 5L	LM39301R-1.8	3A, Fixed, Enable	Reel	Active
	TO-263 5L	LM39301GR-1.8	3A, Fixed, Enable	Reel	Obsolete
	TO-220 3L	LM39300T-1.8	3A, Fixed	Reel	Active
	TO-220 5L	LM39301T-1.8	3A, Fixed, Enable	Reel	Active
2.5 V	TO-263 3L	LM39300R-2.5	3A, Fixed	Reel	Active
	TO-263 3L	LM39300GR-2.5	3A, Fixed	Reel	Obsolete
	TO-263 5L	LM39301R-2.5	3A, Fixed, Enable	Reel	Active
	TO-263 5L	LM39301GR-2.5	3A, Fixed, Enable	Reel	Obsolete
	TO-220 3L	LM39300T-2.5	3A, Fixed	Reel	Active
	TO-220 5L	LM39301T-2.5	3A, Fixed, Enable	Reel	Active
3.3 V	TO-263 3L	LM39300R-3.3	3A, Fixed	Reel	Active
	TO-263 3L	LM39300GR-3.3	3A, Fixed	Reel	Obsolete
	TO-263 5L	LM39301R-3.3	3A, Fixed, Enable	Reel	Active
	TO-263 5L	LM39301GR-3.3	3A, Fixed, Enable	Reel	Obsolete
	TO-220 3L	LM39300T-3.3	3A, Fixed	Reel	Active
	TO-220 5L	LM39301T-3.3	3A, Fixed, Enable	Reel	Active
5.0 V	TO-263 3L	LM39300R-5.0	3A, Fixed	Reel	Active
	TO-263 3L	LM39300GR-5.0	3A, Fixed	Reel	Obsolete
	TO-263 5L	LM39301R-5.0	3A, Fixed, Enable	Reel	Active
	TO-263 5L	LM39301GR-5.0	3A, Fixed, Enable	Reel	Obsolete
	TO-220 3L	LM39300T-5.0	3A, Fixed	Reel	Active
	TO-220 5L	LM39301T-5.0	3A, Fixed, Enable	Reel	Active
ADJ	TO-263 5L	LM39302R	3A, Adjustable, Enable	Reel	Active
	TO-263 5L	LM39302GR	3A, Adjustable, Enable	Reel	Obsolete
	TO-220 5L	LM39302T	3A, Adjustable, Enable	Reel	Active

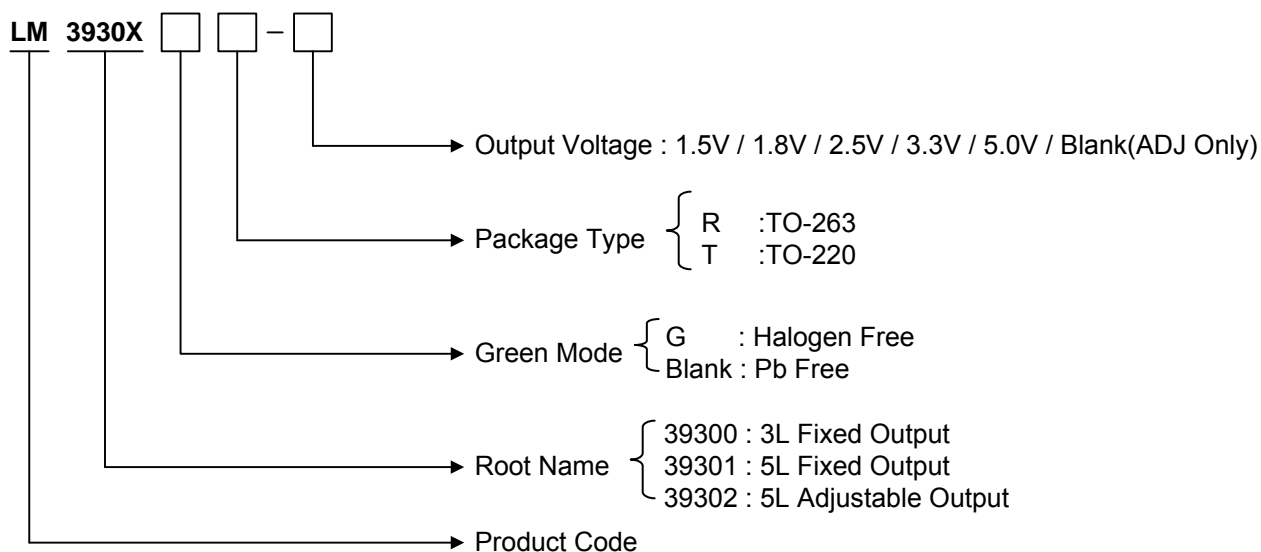

PIN CONFIGURATION

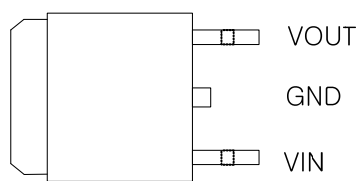

TO263-3L

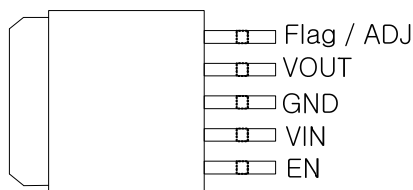

TO263-5L

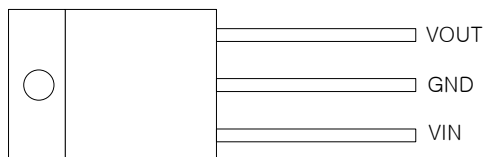

TO220-3L

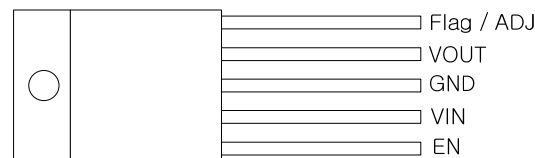

TO220-5L

PIN DESCRIPTION

Pin No.	TO-263 3L / TO-220 3L (for 39300)		TO-263 5L / TO-220 5L (for 39301/2)	
	Name	Function	Name	Function
1	VIN	Input Supply	EN	Chip Enable
2	GND	Ground	VIN	Input Supply
3	VOUT	Output Voltage	GND	Ground
4			VOUT	Output Voltage
5			FLG / ADJ	Error Flag Output or Output Adjust

TYPICAL APPLICATION

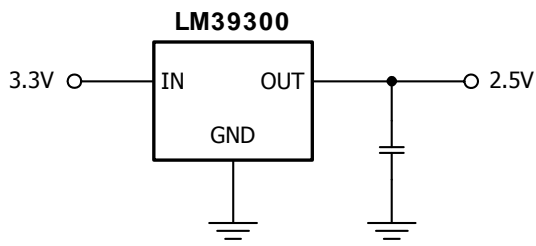

2.5V / 3A Regulator

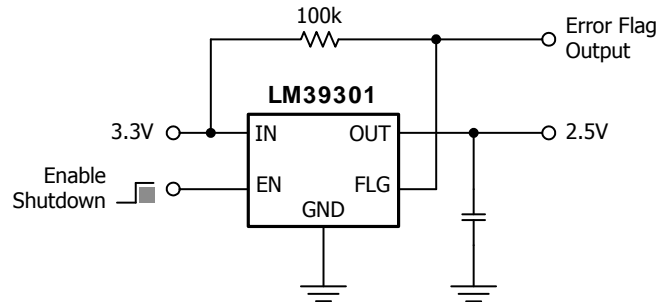

2.5V / 3A Regulator with Error Flag

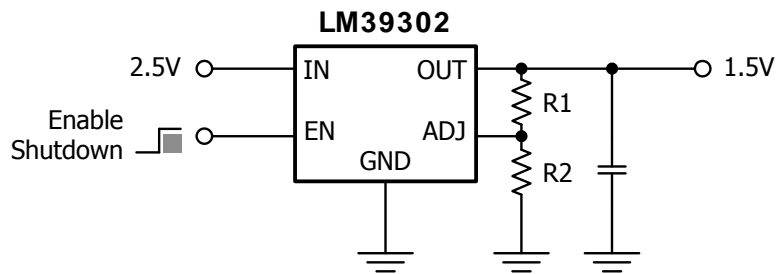

1.5V / 3A Adjustable Regulator

3A Low-Voltage Low-Dropout Regulator

LM39300/39301/39302

Block Diagram

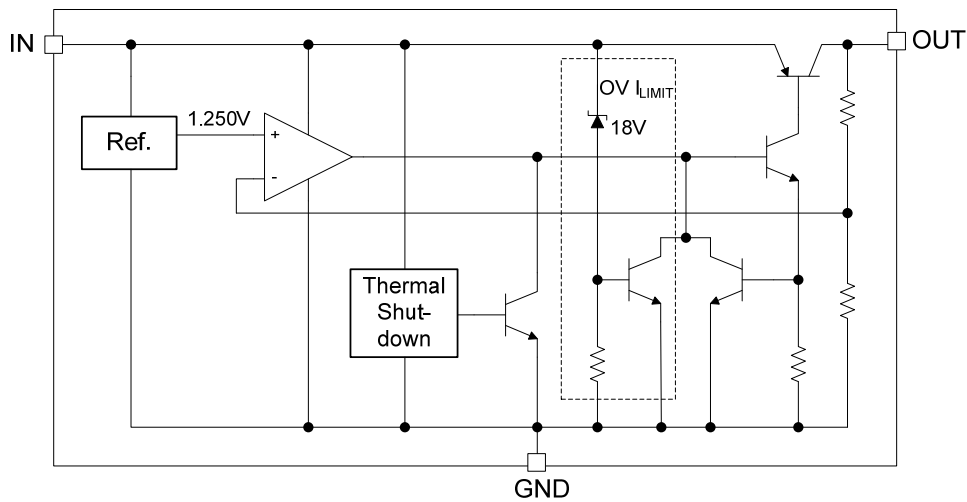

LM39300 Fixed (1.5V, 1.8V, 2.5V, 3.3V, 5.0V)

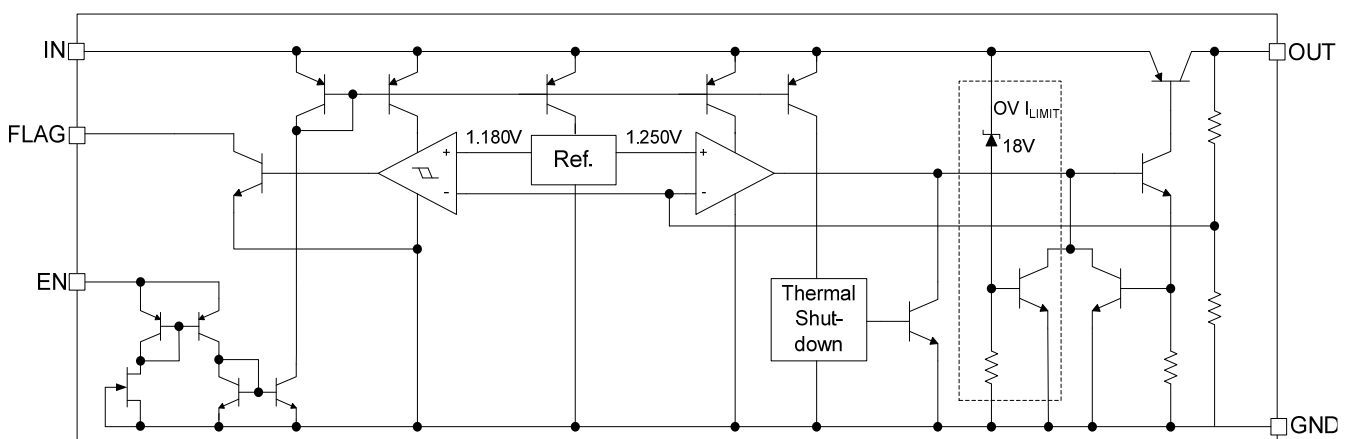

LM39301 Fixed with Flag and Enable

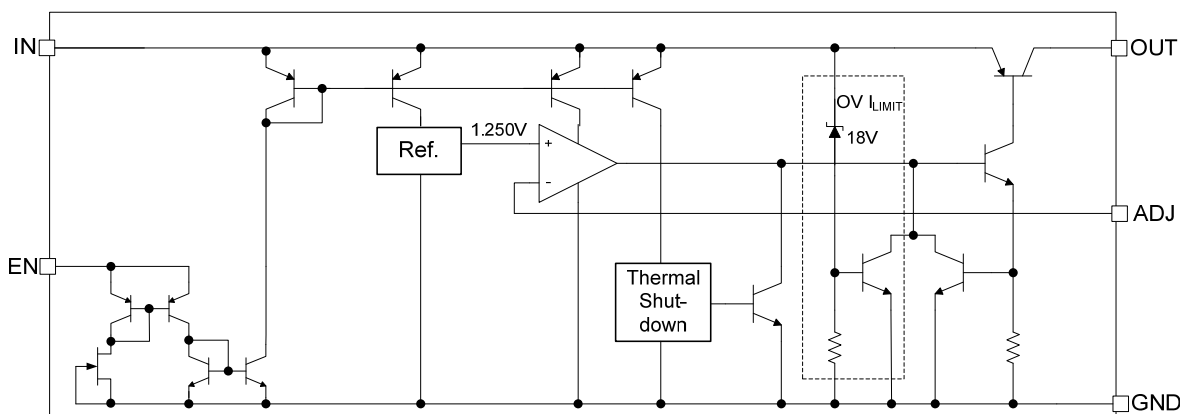

LM39302 Adjustable

ELECTRICAL CHARACTERISTICS

$V_{IN} = V_{OUT} + 1V$; $V_{EN} = 2.25V$; $T_J = 25^\circ C$, **bold** values indicate $-40^\circ C \leq T_J \leq +125^\circ C$; unless noted

Symbol	Parameters	Condition	Min.	Typ.	Max.	Unit
V_{OUT}	Output Voltage	10mA	-1		1	%
		$10mA \leq I_{OUT} \leq 3A, V_{OUT} + 1V \leq V_{IN} \leq 8V$	-2		2	%
	Line Regulation	$I_{OUT} = 10mA, V_{OUT} + 1V \leq V_{IN} \leq 8V$		0.06	0.5	%
	Load Regulation	$V_{IN} = V_{OUT} + 1V, 10mA \leq I_{OUT} \leq 3A$		0.2	1	%
$\Delta V_{OUT}/\Delta T$	Output Voltage Temp. Coefficient (Note 4)			20	100	ppm/°C
V_{DO}	Dropout Voltage (Note 5)	$I_{OUT} = 100mA, \Delta V_{OUT} = -1\%$		80	200	mV mV
		$I_{OUT} = 750mA, \Delta V_{OUT} = -1\%$		200		mV
		$I_{OUT} = 1.5A, \Delta V_{OUT} = -1\%$		320		mV
		$I_{OUT} = 3.0A, \Delta V_{OUT} = -1\%$		400	500	mV mV
I_{GND}	Ground Current (Note 6)	$I_{OUT} = 750mA, V_{IN} = V_{OUT} + 1V$		10	20	mA
		$I_{OUT} = 1.5A, V_{IN} = V_{OUT} + 1V$		17		mA
		$I_{OUT} = 3.0A, V_{IN} = V_{OUT} + 1V$		45		mA
$I_{OUT(lim)}$	Current Limit	$V_{OUT} = 0V, V_{IN} = V_{OUT} + 1V$		4.5		A

Enable Input

V_{EN}	Enable Input Voltage	logic low (off)			0.8	V
		logic high (on)	2.25			V
I_{EN}	Enable Input Current	$V_{EN} = V_{IN}$		15	30 75	μA μA
		$V_{EN} = 0.8V$			2 4	μA μA
$I_{OUT(shdn)}$	Shutdown Output Current	(Note 7)		10	20	μA

Flag Output

$I_{FLG(leak)}$	Output Leakage Current	$V_{OH} = 16V$		0.01	1 2	μA μA
$V_{FLG(do)}$	Output Low Voltage	$V_{IN} = 2.25V, I_{OL} = 250\mu A$, (Note 8)		220	300 400	mV mV
V_{FLG}	Low Threshold	% of V_{OUT}	93			%
	High Threshold				99.2	%
	Hysteresis			1		%

LM39302 Only

	Reference Voltage	(Note9)	1.238 1.225	1.250	1.262 1.275	V V
			1.213		1.277	V
	Adjust Pin Bias Current			40	80 120	nA nA
	Reference Voltage Temp. Coefficient			20		ppm/ °C
	Adjust Pin Bias Current Temp. Coefficient			0.1		nA/ °C

Note 1. Exceeding the absolute maximum ratings may damage the device.

Note 2. The device is not guaranteed to function outside its operating rating.

Note 3. $PD (max) = (T_{J(max)} - T_A) \div \theta_{JA}$, where θ_{JA} - junction-to-ambient thermal resistance.

Note 4. Output voltage temperature coefficient is ΔV_{OUT} (worst case) $\div (T_{J(max)} - T_{J(min)})$ where $T_{J(max)}$ is +125°C and $T_{J(min)}$ is 0°C.

Note 5. $V_{DO} = V_{IN} - V_{OUT}$ when V_{OUT} decreases to 99% of its nominal output voltage with $V_{IN} = V_{OUT} + 1V$. For output voltages below 2.25V, dropout voltage is the input-to-output voltage differential with the minimum input voltage being 2.25V. Minimum input operating voltage is 2.25V.

Note 6. I_{GND} is the quiescent current. $I_{IN} = I_{GND} + I_{OUT}$.

Note 7. $V_{EN} = 0.8V$, $V_{IN} = 8V$, $V_{OUT} = 0V$

Note 8. For a 2.5V device, $V_{IN} = 2.250V$ (device is in dropout).

Note 9. $V_{REF} \leq V_{OUT} \leq (V_{IN} - 1V)$, $2.25V \leq V_{IN} \leq 16V$, $10mA \leq I_L \leq 3A$.

TYPICAL OPERATING CHARACTERISTICS

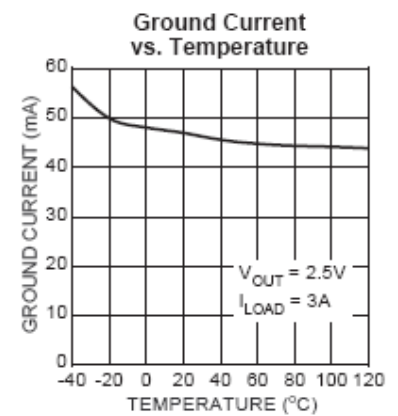
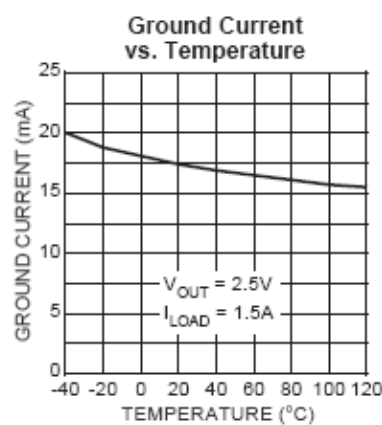
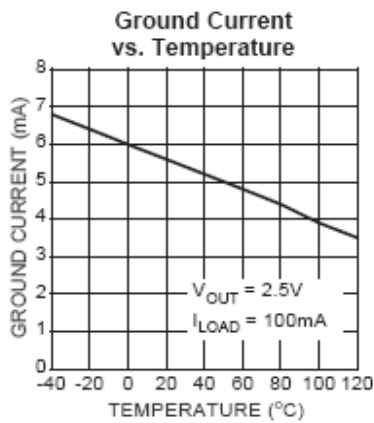
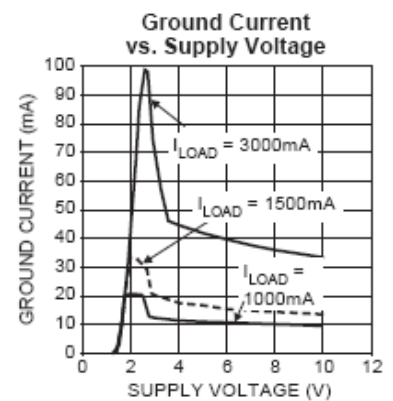
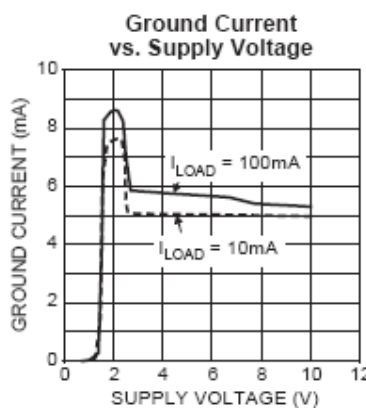
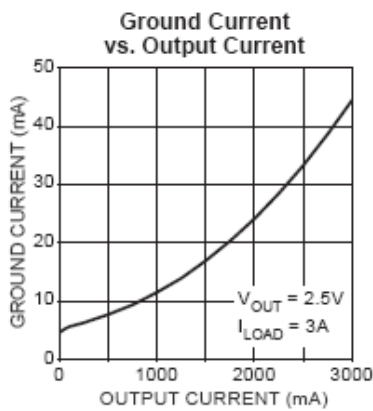
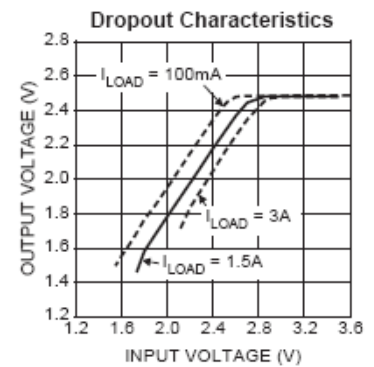
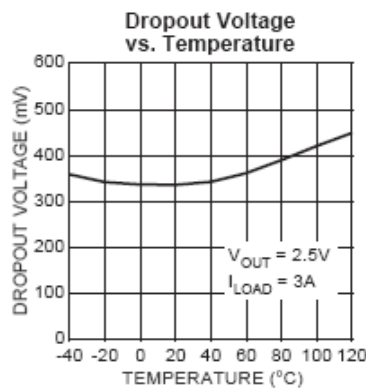
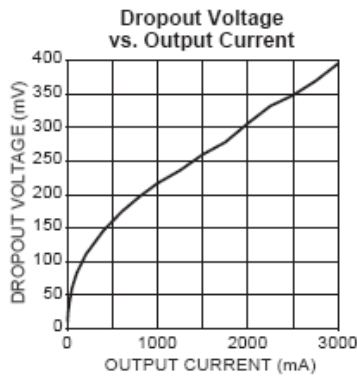

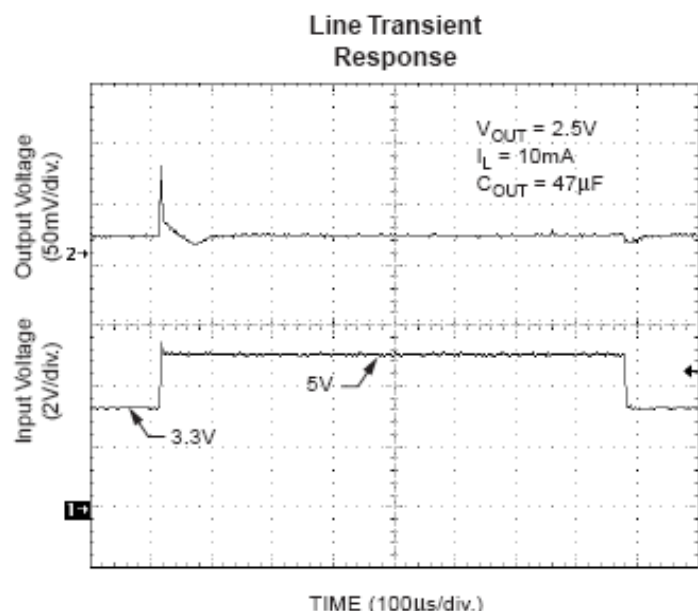
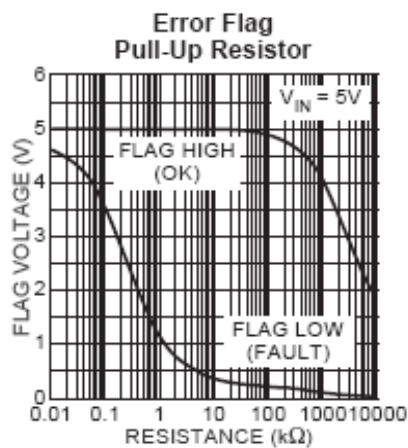
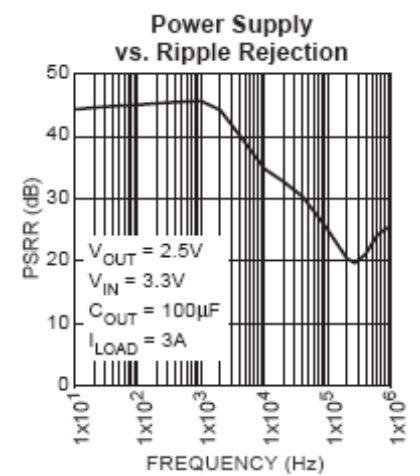
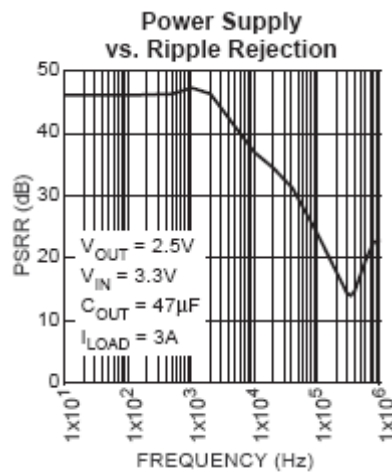
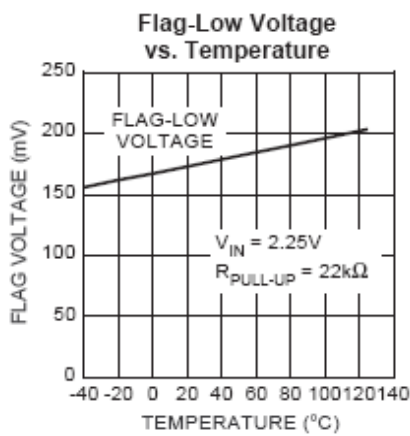
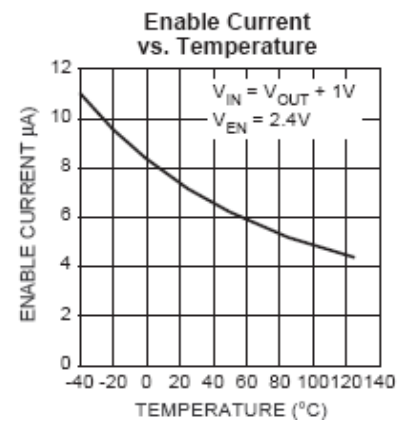
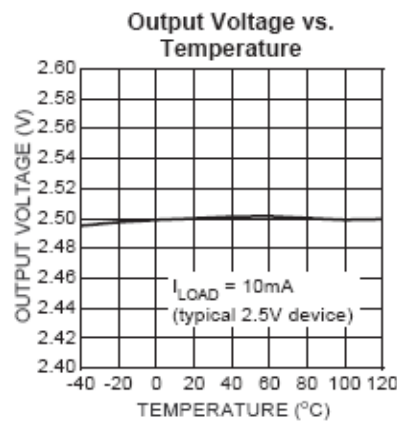
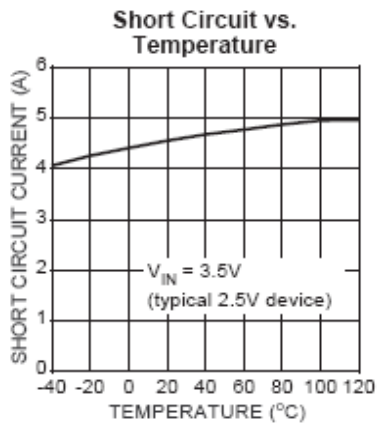

APPLICATION INFORMATION

The LM39300/1 is a high-performance low-dropout voltage regulator suitable for moderate to high-current voltage regulator applications. Its 500mV dropout voltage at full load makes it especially valuable in battery-powered systems and as a high-efficiency noise filter in post-regulator applications. Unlike older NPN-pass transistor designs, where the minimum dropout voltage is limited by the base-to-emitter voltage drop and collector-to-emitter saturation voltage, dropout performance of the PNP output of these devices is limited only by the low VCE saturation voltage. A trade-off for the low dropout voltage is a varying base drive requirement. The LM39300/1/2 regulator is fully protected from damage due to fault conditions. Current limiting is provided. This limiting is linear output current during overload conditions is constant. Thermal shutdown disables the device when the die temperature exceeds the maximum safe operating temperature. Transient protection allows device (and load) survival even when the input voltage spikes above and below nominal. The output structure of these regulators allows voltages in excess of the desired output voltage to be applied without reverse current flow.

Output Capacitor

The LM39300/1/2 requires an output capacitor to maintain stability and improve transient response. Proper capacitor selection is important to ensure proper operation. The LM39300/1/2 output capacitor selection is dependent upon the ESR (equivalent series resistance) of the output capacitor to maintain stability. When the output capacitor is 47 μ F or greater, the output capacitor should have less than 1 Ω of ESR. This will improve transient response as well as promote stability. Ultralow ESR capacitors, such as ceramic chip capacitors may promote instability. These very low ESR levels may cause an oscillation and/or under damped transient response. A low-ESR solid tantalum capacitor works extremely well and provides good transient response and stability over temperature. Aluminum electrolytic can also be used, as long as the ESR of the capacitor is < 1 Ω . The value of the output capacitor can be increased without limit. Higher capacitance values help to improve transient response and ripple rejection and reduce output noise.

Input Capacitor

An input capacitor of 1 μ F or greater is recommended when the device is more than 4 inches away from the bulk ac supply capacitance, or when the supply is a battery. Small, surface-mount, ceramic chip capacitors can be used for the bypassing. Larger values will help to improve ripple rejection by bypassing the input to the regulator, further improving the integrity of the output voltage.

Minimum Load Current

The LM39300/1/2 regulator is specified between finite loads. If the output current is too small, leakage currents dominate and the output voltage rises. A 10mA minimum load current is necessary for proper regulation.

Transient Response and 3.3V to 2.5V Conversion

The LM39300/1/2 has excellent transient response to variations in input voltage and load current. The device has been designed to respond quickly to load current variations and input voltage variations. Large output capacitors are not required to obtain this performance. A standard 47 μ F output capacitor, preferably tantalum, is all that is required. Larger values help to improve performance even further. By virtue of its low-dropout voltage, this device does not saturate into dropout as readily as similar NPN-based designs. When

3A Low-Voltage Low-Dropout Regulator LM39300/39301/39302

converting from 3.3V to 2.5V, the NPN-based regulators are already operating in dropout, with typical dropout requirements of 1.2V or greater. To convert down to 2.5V without operating in dropout, NPN-based regulators require an input voltage of 3.7V at the very least. The LM39300/1/2 regulator will provide excellent performance with an input as low as 3.0V. This gives the PNP-based regulators a distinct advantage over older, NPN-based linear regulator.

Error Flag

The LM39301 version features an error flag circuit which monitors the output voltage and signals an error condition when the voltage drops 5% below the nominal output voltage. The error flag is an open-collector output that can sink 10mA during a fault condition. Low output voltage can be caused by a number of problems, including an over current fault (device in current limit) or low input voltage. The flag is inoperative during over temperature shutdown.

Enable Input

The LM39301 version features an enable input for on/off control of the device. Its shutdown state draws “zero” current (only microamperes of leakage). The enable input is TTL/ CMOS compatible for simple logic interface, but can be connected to up to 20V. When enabled, it draws approximately 15A.

Adjustable Regulator Design

The LM39302 allows programming the output voltage any-where between 1.25V and the 16V maximum operating rating of the family. Two resistors are used. Resistors can be quite large, up to 1MΩ, because of the very high input impedance and low bias current of the sense comparator: The resistor values are calculated by: $R1=R2(V_{out}/1.250-1)$

Where VO is desired output voltage. Figure 1 shows component definition. Applications with widely varying load currents may scale the resistors to draw the minimum load current required for proper operation (see below).

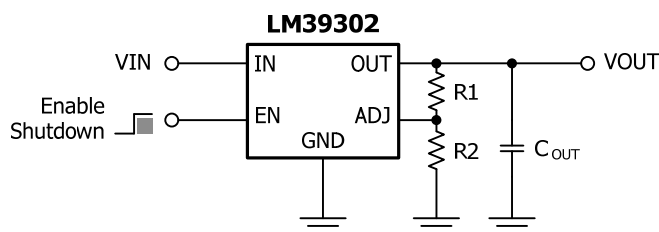

Figure 1. Adjustable Regulator with Resistors

Maximum Output Current Capability

The LM39300/1/2 can deliver a continuous current of 3A over the full operating junction temperature range. However, the output current is limited by the restriction of power dissipation which differs from packages. A heat sink may be required depending on the maximum power dissipation and maximum ambient temperature of application. With respect to the applied package, the maximum output current of 3A may be still undeliverable due to the restriction of the power dissipation of LM39300/1/2. Under all possible conditions, the junction temperature must be within the range specified under operating conditions. The temperatures over the device are given by:

$$T_C = T_A + P_D \times \theta_{CA} / \quad T_J = T_C + P_D \times \theta_{JC} / \quad T_J = T_A + P_D \times \theta_{JA}$$

3A Low-Voltage Low-Dropout Regulator LM39300/39301/39302

Where T_J is the junction temperature, T_C is the case temperature, T_A is the ambient temperature, P_D is the total power dissipation of the device, θ_{CA} is the thermal resistance of case-to-ambient, θ_{JC} is the thermal resistance of junction-to-case, and θ_{JA} is the thermal resistance of junction to ambient. The total power dissipation of the device is given by:

$$P_D = P_{IN} - P_{OUT} = (V_{IN} \times I_{IN}) - (V_{OUT} \times I_{OUT}) \\ = (V_{IN} \times (I_{OUT} + I_{GND})) - (V_{OUT} \times I_{OUT}) = (V_{IN} - V_{OUT}) \times I_{OUT} + V_{IN} \times I_{GND}$$

Where I_{GND} is the operating ground current of the device which is specified at the Electrical Characteristics. The maximum allowable temperature rise (T_{Rmax}) depends on the maximum ambient temperature (T_{Amax}) of the application, and the maximum allowable junction temperature (T_{Jmax}):

$$T_{Rmax} = T_{Jmax} - T_{Amax}$$

The maximum allowable value for junction-to-ambient thermal resistance, θ_{JA} , can be calculated using the formula:

$$\theta_{JA} = T_{Rmax} / P_D = (T_{Jmax} - T_{Amax}) / P_D$$

LM39300/1/2 is available in TO-263 and TO-220 package. The thermal resistance depends on amount of copper area or heat sink, and on air flow. If the maximum allowable value of θ_{JA} calculated above is over 80°C/W for TO-263 package, 70°C/W for TO-220 package, no heat sink is needed since the package can dissipate enough heat to satisfy these requirements. If the value for allowable θ_{JA} falls near or below these limits, a heat sink or proper area of copper plane is required. In summary, the absolute maximum ratings of thermal resistances are as follow:

Absolute Maximum Ratings of Thermal Resistance

Characteristic	Symbol	Rating	Unit
Thermal Resistance Junction-To-Ambient / TO-263	$\theta_{JA-TO-263}$	80	°C/W
Thermal Resistance Junction-To-Ambient / TO-220	$\theta_{JA-TO-220}$	70	°C/W

No heat sink / No air flow / No adjacent heat source / 20 mm² copper area. ($T_A=25^\circ\text{C}$)