

Medium Bi-Pin Lampholders



594 Series Thin, Rapid Start, Lampholders

Specifications

Rating: 660 Watts, 600 V

Listing: UL File No. E-13408; CSA File No. LR95423

Mounting: Butt-on or bracket mounting

Materials:

Housing: White urea

Contacts: Copper alloy, surface wipe configuration

Termination: Lead wires 9" (228.6 mm) long, 18 AWG stranded and tinned lead wires, 1/2" stripped, standard.

Wire Rated: AWM 600 V, 105°C (221°F).

Brackets: Cold rolled steel, zinc plated.

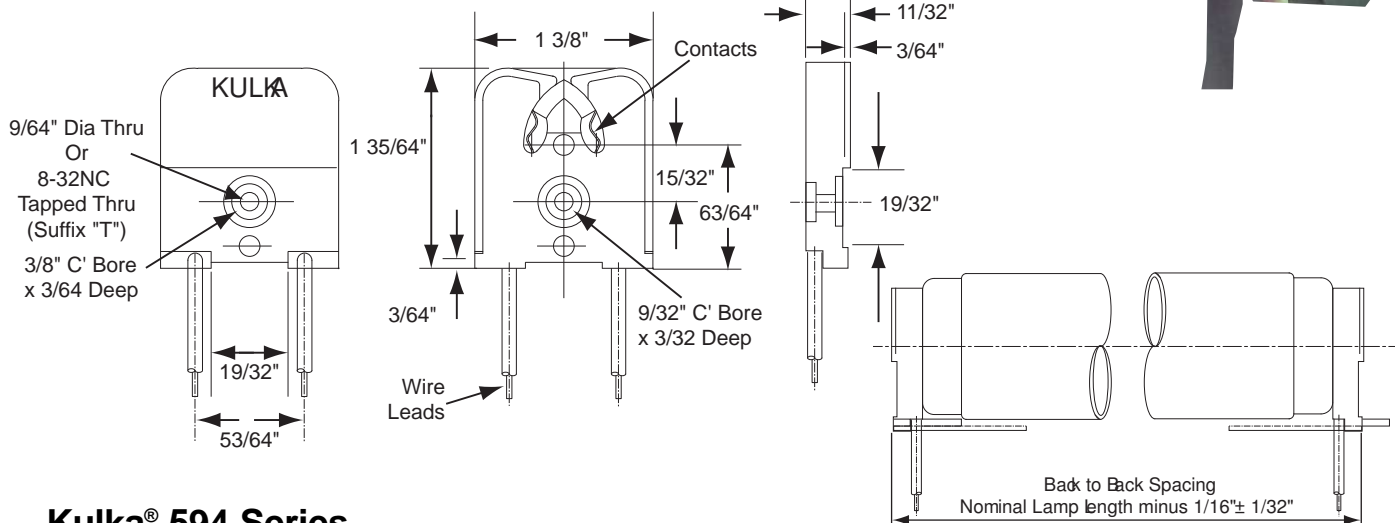
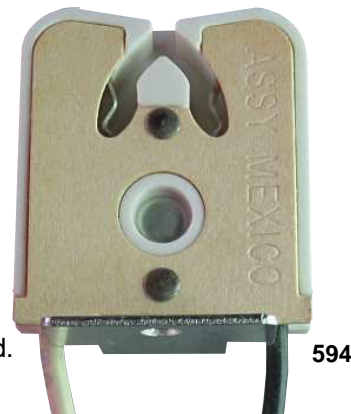

Kulka® 594 Series

Part No.

594	.140" Dia. clearance hole
594.T	#8-32 Tapped thread
594.BR1†	Below panel, with #6 screw and 0.140" boss
594.BR2†	Below panel, 0.144" dia. hole and 0.140" boss
594.BR4†	Below panel, 0.144" dia. hole
594.BR5†	Below panel, 0.144" dia. hole and 0.140" boss
594.BR6†	Below panel, 0.171" dia. hole
594.BR7†	Below panel, 0.171" dia. hole and 0.140" boss
594.BR8†	Below panel, #6 screw
594.BR10†	Above panel, 0.171" dia hole

594.BR13† Below panel, #6 screw

594.BR14† Below panel, #6 screw

594.BR15† Below panel, with #6 screw and 0.140" boss

594.BR16† Below panel, 0.136" dia holes (two holes)

594.BR17† Below panel, 0.144" dia hole

594.BR18† Below panel, 0.144" dia hole and 0.140" boss

594.BR19† Below panel, #6 screw

594.BR21† Below panel, 0.171" dia hole

Mounted: Center of lamp to top of bracket, mounting surface = 1.03"
All Brackets listed at right are mounted at right angle to lampholder

Packed 500/ box. **Special lead wire lengths available upon request, consult sales department.**

Brackets are not sold separately.

†supplied with No. 4/36 x 3/8" mounting screws in bulk (p/n 8043.612.002)

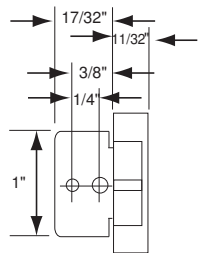

BR1

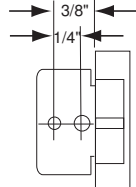

BR2

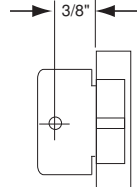

BR4

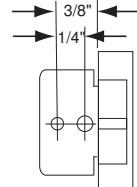

BR5

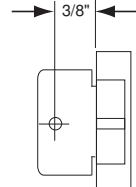

BR6

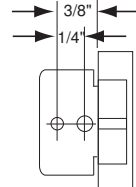

BR7

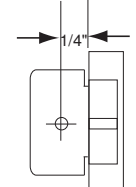

BR8

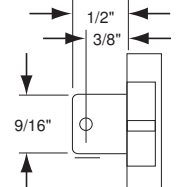

BR10

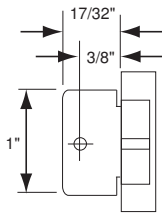
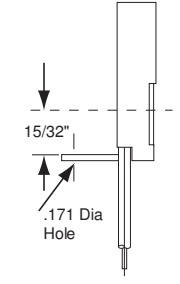
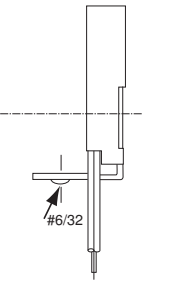
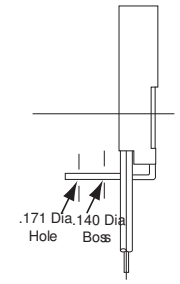
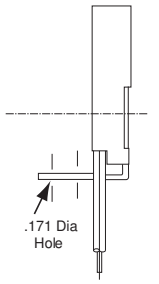
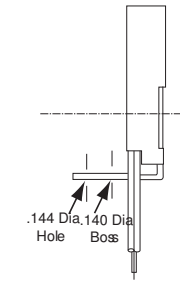
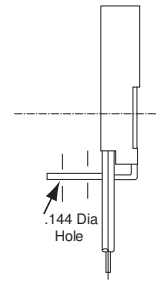
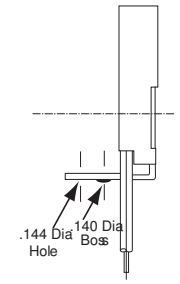
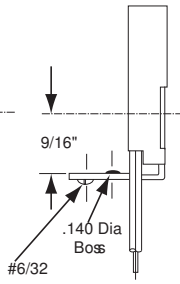
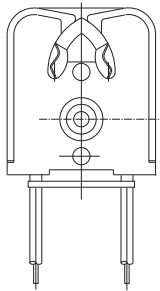

BR13

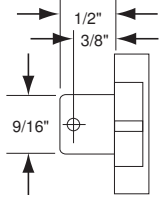

BR14

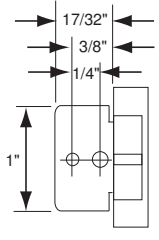

BR15

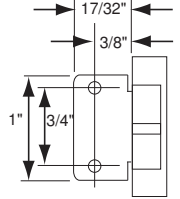

BR16

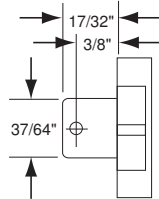

BR17

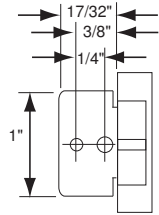

BR18

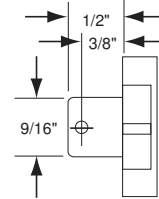

BR19

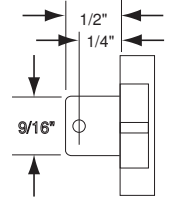

BR21

