

HA-2541

40MHz, Fast Settling, Unity Gain Stable, Operational Amplifier

The HA-2541 is the first unity gain stable monolithic operational amplifier to achieve 40MHz unity gain bandwidth. A major addition to the Harris series of high speed, wideband op amps, the HA-2541 is designed for video and pulse applications requiring stable amplifier response at low closed loop gains.

The uniqueness of the HA-2541 is that its slew rate and bandwidth characteristics are specified at unity gain. Historically, high slew rate, wide bandwidth and unity gain stability have been incompatible features for a monolithic operational amplifier. But features such as 250V/ μ s slew rate and 40MHz unity gain bandwidth clearly show that this is not the case for the HA-2541. These features, along with 90ns settling time to 0.1%, make this product an excellent choice for high speed data acquisition systems.

Rochester Electronics Manufactured Components

Rochester branded components are manufactured using either die/wafers purchased from the original suppliers or Rochester wafers recreated from the original IP. All recreations are done with the approval of the OCM.

Parts are tested using original factory test programs or Rochester developed test solutions to guarantee product meets or exceeds the OCM data sheet.

Quality Overview

- ISO-9001
- AS9120 certification
- Qualified Manufacturers List (QML) MIL-PRF-38535
 - Class Q Military
 - Class V Space Level
- Qualified Suppliers List of Distributors (QSLD)
 - Rochester is a critical supplier to DLA and meets all industry and DLA standards.

Rochester Electronics, LLC is committed to supplying products that satisfy customer expectations for quality and are equal to those originally supplied by industry manufacturers.

The original manufacturer's datasheet accompanying this document reflects the performance and specifications of the Rochester manufactured version of this device. Rochester Electronics guarantees the performance of its semiconductor products to the original OEM specifications. 'Typical' values are for reference purposes only. Certain minimum or maximum ratings may be based on product characterization, design, simulation, or sample testing.

November 1996

40MHz, Fast Settling, Unity Gain Stable, Operational Amplifier

Features

- Unity Gain Bandwidth 40MHz
- High Slew Rate 250V/ μ s
- Low Offset Voltage 0.8mV
- Fast Settling Time (0.1%) 90ns
- Power Bandwidth 4MHz
- Output Voltage Swing (Min) $\pm 10V$
- Unity Gain Stability
- Monolithic Bipolar Dielectric Isolation Construction

Applications

- Pulse and Video Amplifiers
- Wideband Amplifiers
- High Speed Sample-Hold Circuits
- Fast, Precise D/A Converters
- High Speed A/D Input Buffer

For a lower power version of this product, please see the HA-2841 data sheet.

Description

The HA-2541 is the first unity gain stable monolithic operational amplifier to achieve 40MHz unity gain bandwidth. A major addition to the Harris series of high speed, wideband op amps, the HA-2541 is designed for video and pulse applications requiring stable amplifier response at low closed loop gains.

The uniqueness of the HA-2541 is that its slew rate and bandwidth characteristics are specified at unity gain. Historically, high slew rate, wide bandwidth and unity gain stability have been incompatible features for a monolithic operational amplifier. But features such as 250V/ μ s slew rate and 40MHz unity gain bandwidth clearly show that this is not the case for the HA-2541. These features, along with 90ns settling time to 0.1%, make this product an excellent choice for high speed data acquisition systems.

MIL-STD-883 product and data sheets are available upon request, Harris AnswerFAX (407-724-7800) document #3698.

For further application suggestions on the HA-2541, please refer to Application Note AN550 (Using the HA-2541), and Application Note AN556 (Thermal Safe Operating Areas for High Current Operational Amplifiers), Harris AnswerFAX (407-724-7800) document #9550 and 9556. Also see 'Applications' in this data sheet.

Ordering Information

PART NUMBER	TEMP. RANGE (°C)	PACKAGE	PKG. NO.
HA1-2541-2	-55 to 125	14 Ld CERDIP	F14.3
HA1-2541-5	0 to 75	14 Ld CERDIP	F14.3
HA2-2541-2	-55 to 125	12 Pin Metal Can	T12.C
HA2-2541-5	0 to 75	12 Pin Metal Can	T12.C

Pinouts

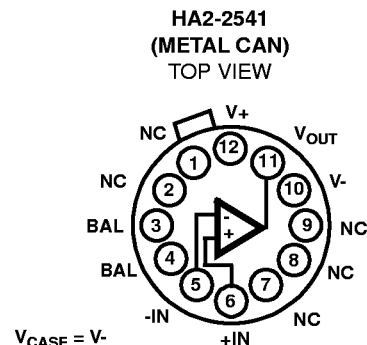
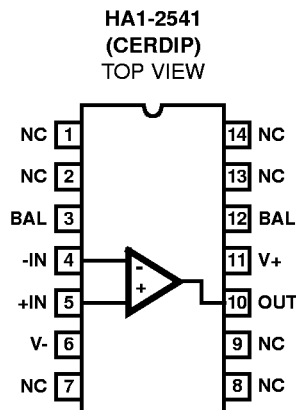

HA-2541

Absolute Maximum Ratings

Voltage Between V+ and V- Terminals	35V
Differential Input Voltage	6V
Peak Output Current	50mA
Continuous Output Current	28mA _{RMS}

Thermal Information

Thermal Resistance (Typical, Note 2)	θ_{JA} (°C/W)	θ_{JC} (°C/W)
CERDIP Package	75	20
Can Package	65	34
Maximum Junction Temperature (Note 1)	175°C	
Maximum Storage Temperature Range	-65°C to 150°C	
Maximum Lead Temperature (Soldering 10s)	300°C	

Operating Conditions

Temperature Range	
HA-2541-2	-55°C to 125°C
HA-2541-5	0°C to 75°C

CAUTION: Stresses above those listed in "Absolute Maximum Ratings" may cause permanent damage to the device. This is a stress only rating and operation of the device at these or any other conditions above those indicated in the operational sections of this specification is not implied.

NOTES:

- Maximum power dissipation with load conditions must be designed to maintain the maximum junction temperature below 175°C. By using Application Note AN556 on Safe Operating Area equations, along with the thermal resistances, proper load conditions can be determined. Heat sinking is recommended above 75°C.
- θ_{JA} is measured with the component mounted on an evaluation PC board in free air.

Electrical Specifications $V_{SUPPLY} = \pm 15V, R_L = 1k\Omega, C_L \leq 10pF$, Unless Otherwise Specified

PARAMETER	TEST CONDITIONS	TEMP (°C)	HA-2541-2 -55°C to 125°C			HA-2541-5 0°C to 75°C			UNITS
			MIN	TYP	MAX	MIN	TYP	MAX	
INPUT CHARACTERISTICS									
Offset Voltage		25	-	0.8	2	-	1	2	mV
		Full	-	-	6	-	-	6	mV
Average Offset Voltage Drift		Full	-	9	-	-	9	-	$\mu V/^\circ C$
Bias Current		25	-	11	35	-	11	35	μA
		Full	-	-	50	-	-	50	μA
Average Bias Current Drift		Full	-	85	-	-	85	-	$nA/^\circ C$
Offset Current		25	-	1	7	-	1	7	μA
		Full	-	-	9	-	-	9	μA
Input Resistance		25	-	100	-	-	100	-	k Ω
Input Capacitance		25	-	1	-	-	1	-	pF
Common Mode Range		Full	± 10	± 11	-	± 10	± 11	-	V
Input Noise Voltage	$f = 1kHz, R_g = 0\Omega$	25	-	10	-	-	10	-	nV/\sqrt{Hz}
Input Noise Current	$f = 1kHz, R_g = 0\Omega$	25	-	4	-	-	4	-	pA/\sqrt{Hz}
TRANSFER CHARACTERISTICS									
Large Signal Voltage Gain	$V_O = \pm 10V$	25	10	16	-	10	16	-	kV/V
		Full	5	-	-	5	-	-	kV/V
Common Mode Rejection Ratio	$V_{CM} = \pm 10V$	Full	70	90	-	70	90	-	dB
Minimum Stable Gain		25	1	-	-	1	-	-	V/V
Unity Gain Bandwidth	$V_O = 90mV$	25	-	40	-	-	40	-	MHz
OUTPUT CHARACTERISTICS									
Output Voltage Swing	$R_L = 1k\Omega$	Full	± 10	± 11	-	± 10	± 11	-	V
Output Current	$R_L = 1k\Omega$	25	± 10	± 15	-	± 10	± 15	-	mA
Output Resistance		25	-	2	-	-	2	-	Ω
Full Power Bandwidth (Note 3)	$V_P = 10V$	25	3	4	-	3	4	-	MHz
Differential Gain	Note 4	25	-	0.1	-	-	0.1	-	%
Differential Phase	Note 4	25	-	0.2	-	-	0.2	-	Degrees

Electrical Specifications $V_{SUPPLY} = \pm 15V$, $R_L = 1k\Omega$, $C_L \leq 10pF$, Unless Otherwise Specified (Continued)

PARAMETER	TEST CONDITIONS	TEMP (°C)	HA-2541-2 -55°C to 125°C			HA-2541-5 0°C to 75°C			UNITS
			MIN	TYP	MAX	MIN	TYP	MAX	
Harmonic Distortion	Note 6	25	-	<0.01	-	-	<0.01	-	%
TRANSIENT RESPONSE (Note 5)									
Rise Time		25	-	4	-	-	4	-	ns
Overshoot		25	-	40	-	-	40	-	%
Slew Rate		25	200	250	-	200	250	-	V/μs
Settling Time	10V Step To 0.1%	25	-	90	-	-	90	-	ns
	10V Step To 0.01%	25	-	175	-	-	175	-	ns
POWER REQUIREMENTS									
Supply Current		25	-	29	-	-	29	-	mA
		Full	-	-	40	-	-	40	mA
Power Supply Rejection Ratio	$V_S = \pm 5V$ to $\pm 15V$	Full	70	80	-	70	78	-	dB

NOTES:

- Full Power Bandwidth guaranteed based on slew rate measurement using: $FPBW = \frac{Slew\ Rate}{2\pi V_{PEAK}}$.
- Differential Gain and Phase are measured with a 1V differential voltage at 5MHz.
- Refer to Test Circuits section of this data sheet.
- $f = 10kHz$; $A_V = 5$; $V_O = 14V_{P-P}$.

Test Circuits and Waveforms

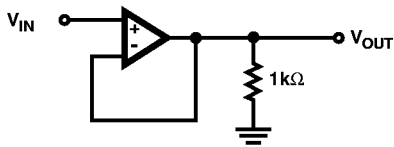

- NOTES:
- $V_S = \pm 15V$.
 - $A_V = +1$.
 - $C_L \leq 10pF$.

FIGURE 1. TRANSIENT RESPONSE TEST CIRCUIT

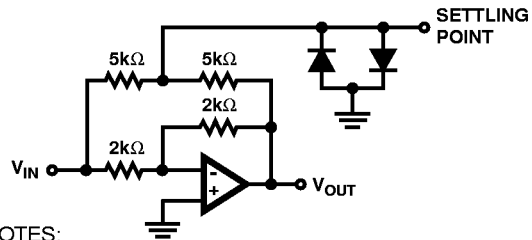

- NOTES:
- $A_V = -1$.
 - Feedback and summing resistor ratios should be 0.1% matched.
 - HP5082-2810 clipping diodes recommended.
 - Tektronix P6201 FET probe used at settling point.

FIGURE 2. SETTLING TIME TEST CIRCUIT

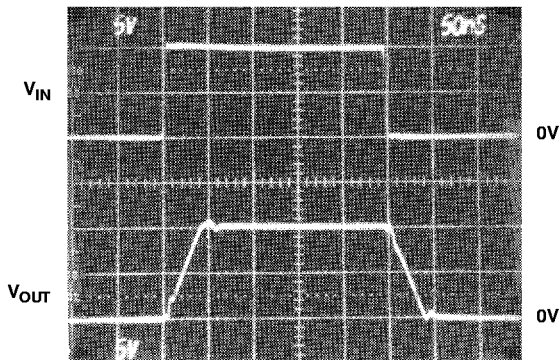

Vertical Scale: 5V/Div.
Horizontal Scale: 50ns/Div.

LARGE SIGNAL RESPONSE

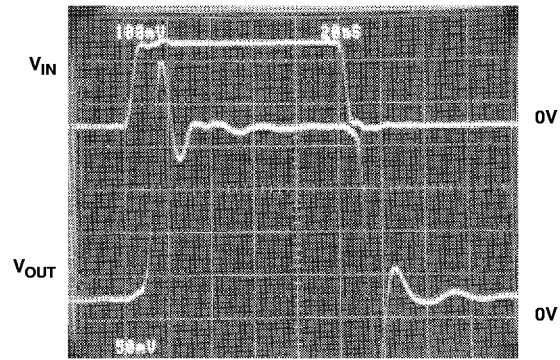

Vertical Scale: $V_{IN} = 100mV/Div$, $V_{OUT} = 50mV/Div$.
Horizontal Scale: 20ns/Div.

SMALL SIGNAL RESPONSE

Test Circuits and Waveforms (Continued)

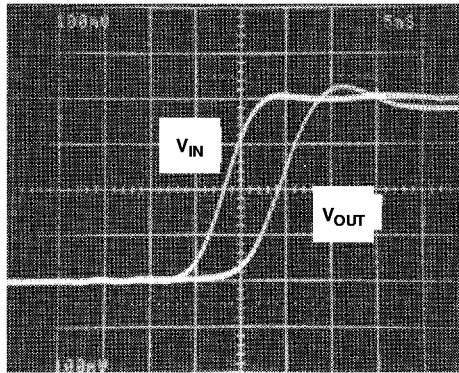

NOTES:

- 14. $V_S = \pm 15V$, $R_L = 1k\Omega$.
- 15. $T_A = 25^\circ C$.
- 16. Propagation delay variance is negligible over full temperature range.

Vertical Scale: 100mV/Div.
Horizontal Scale: 5ns/Div.

PROPAGATION DELAY

Schematic Diagram

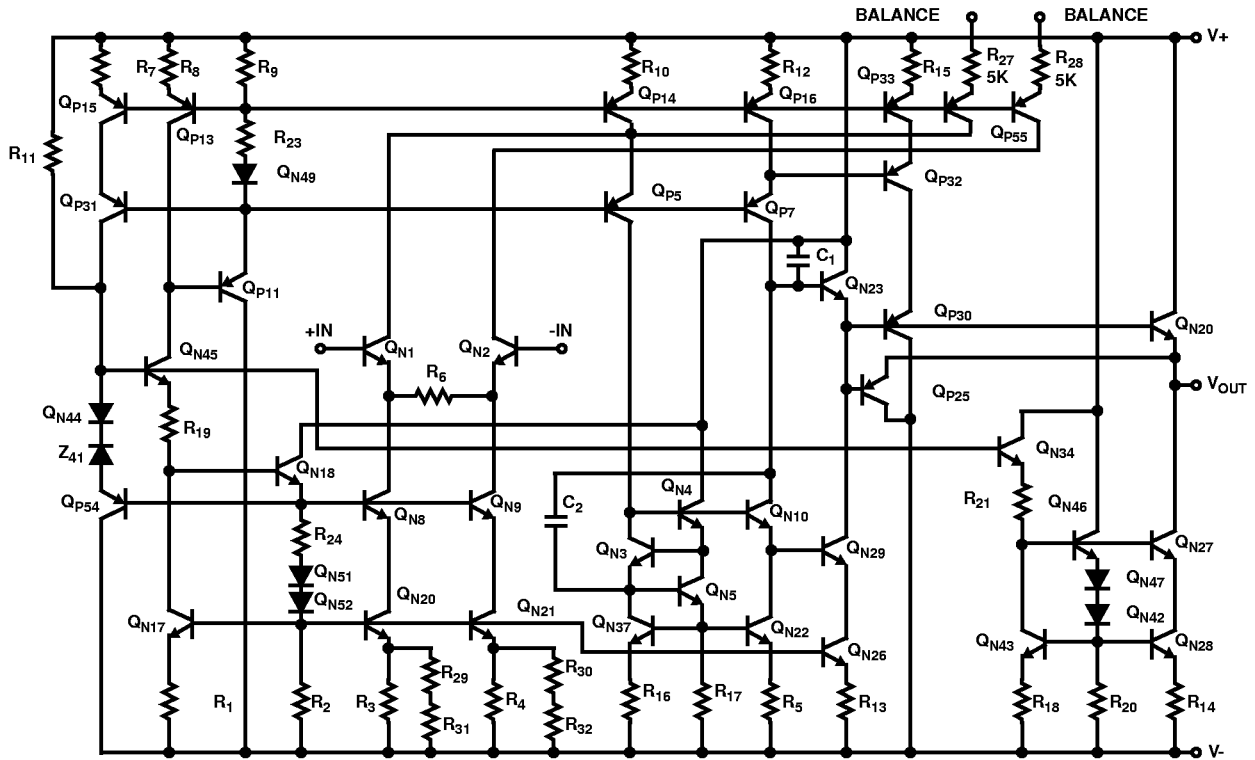

Typical Applications (Also see Application Note AN550)

Application 1

High power amplifiers and buffers are in use in a wide variety of applications. Many times the "high power" capability is needed to drive large capacitive loads as well as low value resistive loads. In both cases the final driver stage is usually a power transistor of some type, but because of their inherently low gain, several stages of pre-drivers are often required. The HA-2541, with its 10mA output rating, is powerful enough to drive a power transistor without additional stages of current amplification. This capability is well demonstrated with the high power buffer circuit in Figure 3.

The HA-2541 acts as the pre-driver to the output power transistor. Together, they form a unity gain buffer with the ability to drive three 50Ω coaxial cables in parallel, each with a capacitance of 2000pF. The total combined load is 16.6Ω and 6000pF capacitance.

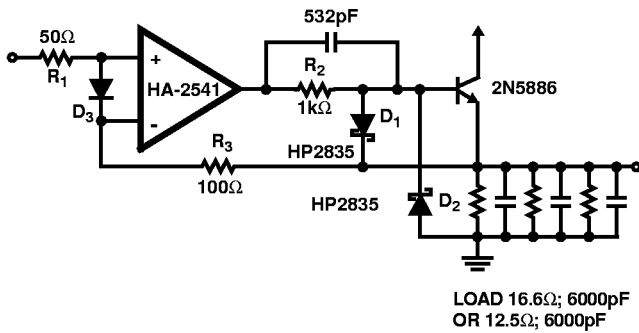

FIGURE 3. DRIVING POWER TRANSISTORS TO GAIN ADDITIONAL CURRENT BOOSTING

Application 2

Video

One of the primary uses of the HA-2541 is in the area of video applications. These applications include signal construction, synchronization addition and removal, as well as signal modification. A wide bandwidth device such as the HA-2541 is well suited for use in this class of amplifier. This, however, is a more involved group of applications than ordinary amplifier applications since video signals contain precise DC levels which must be retained.

The addition of a clamping circuit restores DC levels at the output of an amplifier stage. The circuit shown in Figure 4 utilizes the HA-5320 sample and hold amplifier as the DC clamp. Also shown is a 3.57MHz trap in series, which will block the color burst portion of the video signal and allow the DC level to be amplified and restored.

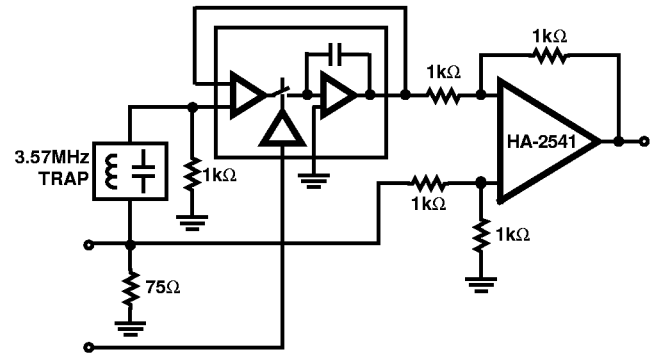
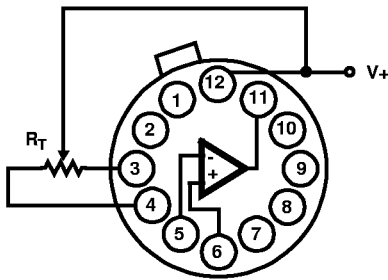

FIGURE 4. VIDEO DC RESTORER

Suggested Offset Voltage Adjustment



NOTE: Tested Offset Adjustment Range is $|V_{OS} + 1\text{mV}|$ minimum referred to output. Typical range is $\pm 15\text{mV}$ for $R_T = 5\text{k}\Omega$.

Typical Performance Curves

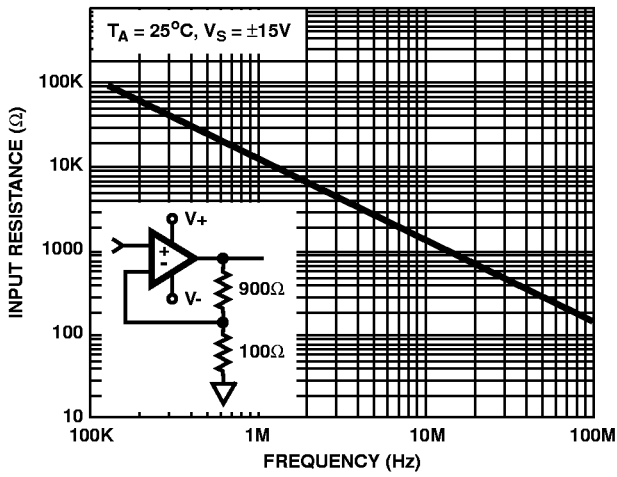

FIGURE 5. INPUT RESISTANCE vs FREQUENCY

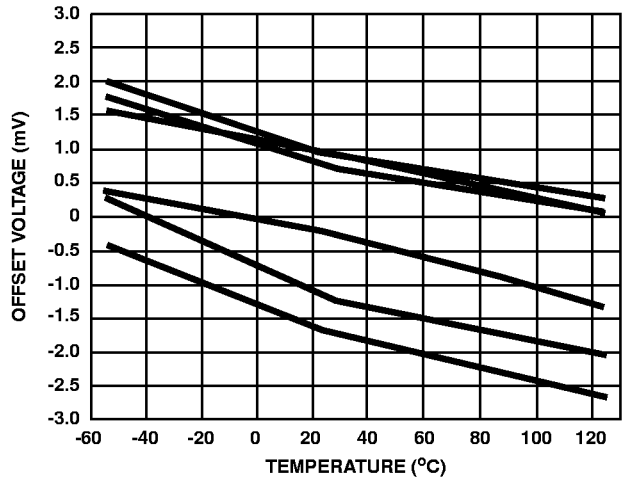

FIGURE 6. OFFSET VOLTAGE vs TEMPERATURE
(6 REPRESENTATIVE UNITS)

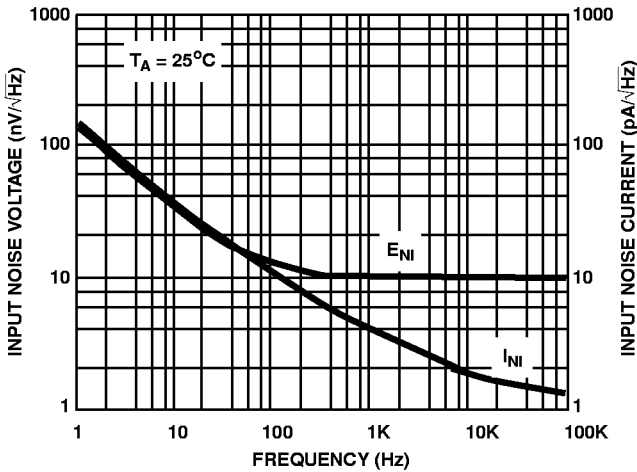

FIGURE 7. NOISE DENSITY vs FREQUENCY

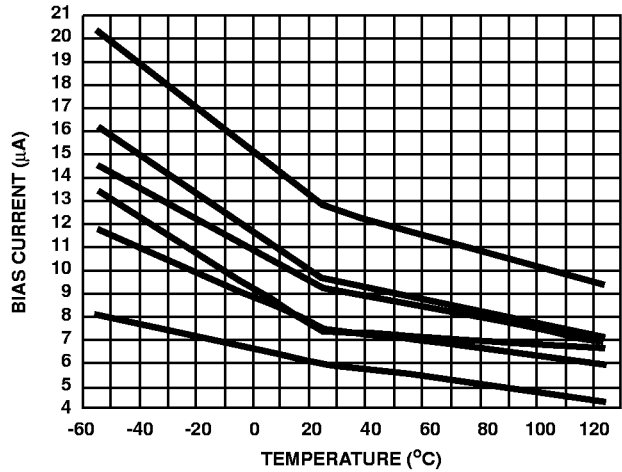

FIGURE 8. BIAS CURRENT vs TEMPERATURE
(6 REPRESENTATIVE UNITS)

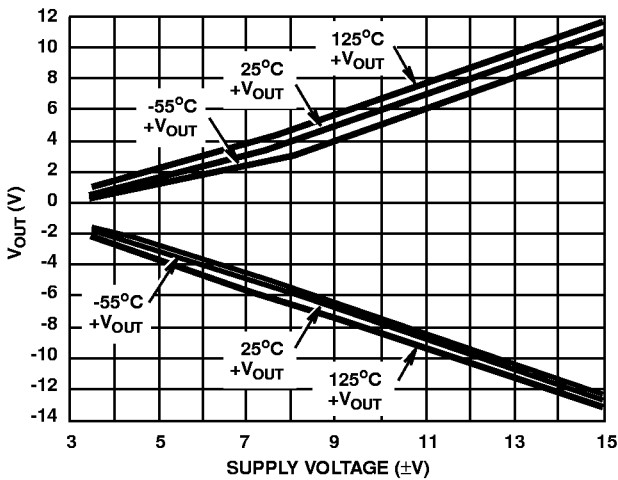

FIGURE 9. OUTPUT VOLTAGE SWING vs SUPPLY VOLTAGE

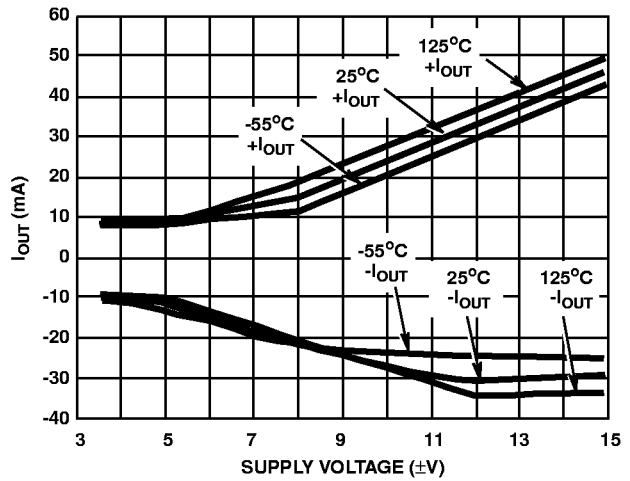

FIGURE 10. OUTPUT CURRENT vs SUPPLY VOLTAGE

Typical Performance Curves (Continued)

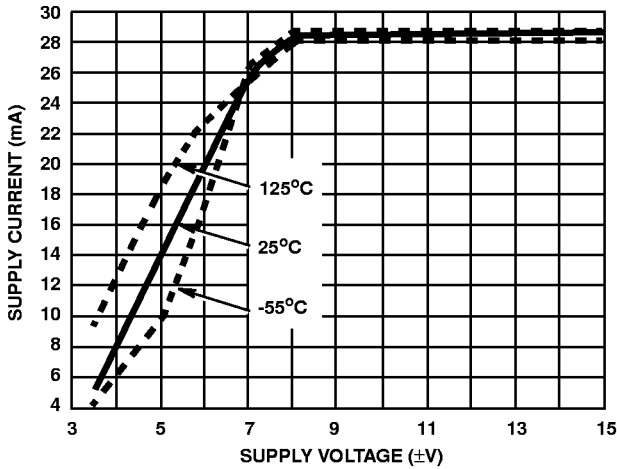

FIGURE 11. SUPPLY CURRENT vs SUPPLY VOLTAGE

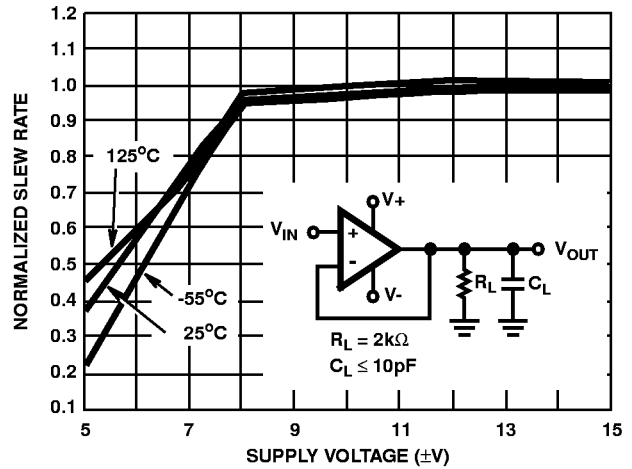

FIGURE 12. SLEW RATE vs SUPPLY VOLTAGE (NORMALIZED WITH $V_S = \pm 15V$ AT $25^\circ C$)

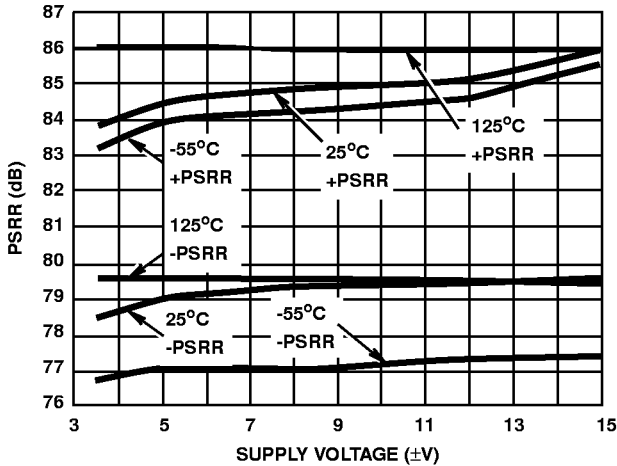

FIGURE 13. PSRR vs SUPPLY VOLTAGE (AVERAGE OF 3 LOTS)

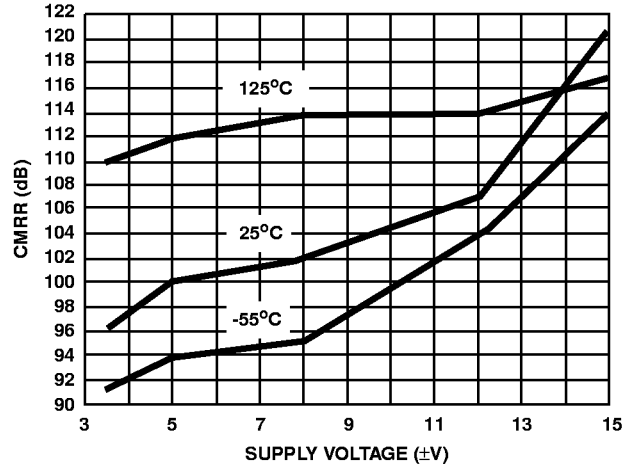

FIGURE 14. CMRR vs SUPPLY VOLTAGE (AVERAGE OF 3 LOTS)

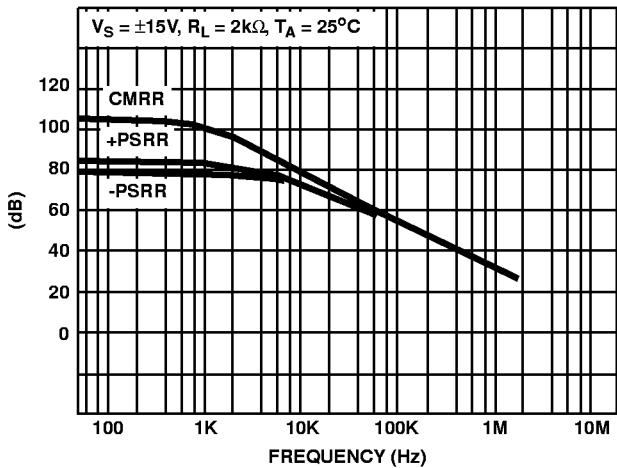

FIGURE 15. REJECTION RATIOS vs FREQUENCY

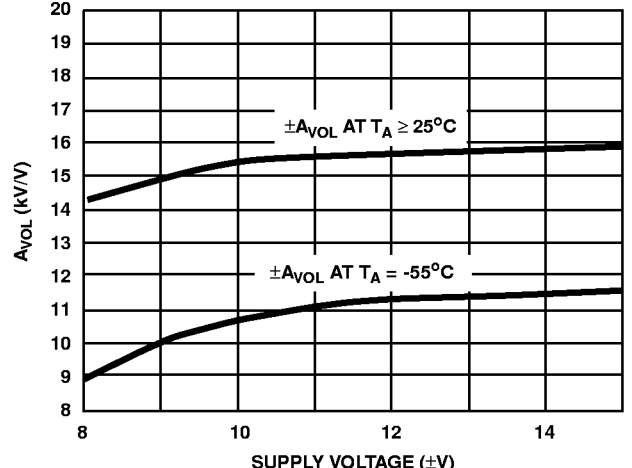

FIGURE 16. OPEN LOOP GAIN vs SUPPLY VOLTAGE (AVERAGE OF 3 LOTS)

Typical Performance Curves (Continued)

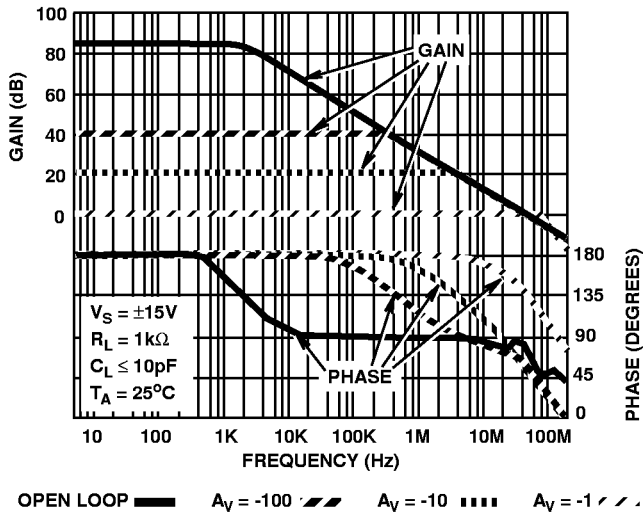

FIGURE 17. GAIN AND PHASE FREQUENCY RESPONSE

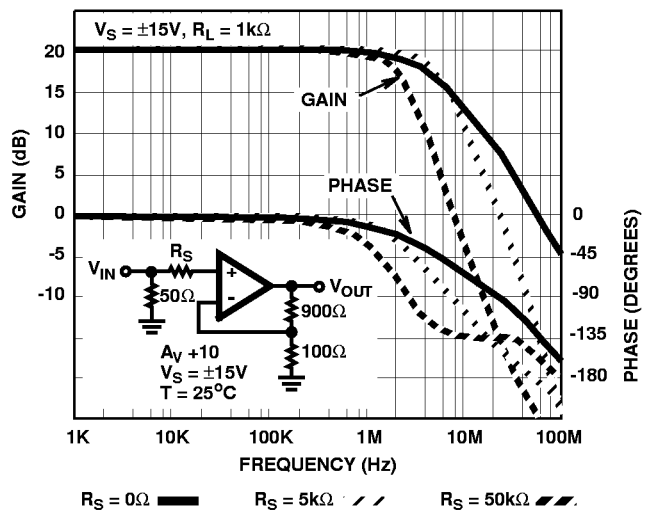

FIGURE 18. SMALL SIGNAL BANDWIDTH vs SOURCE RESISTANCE

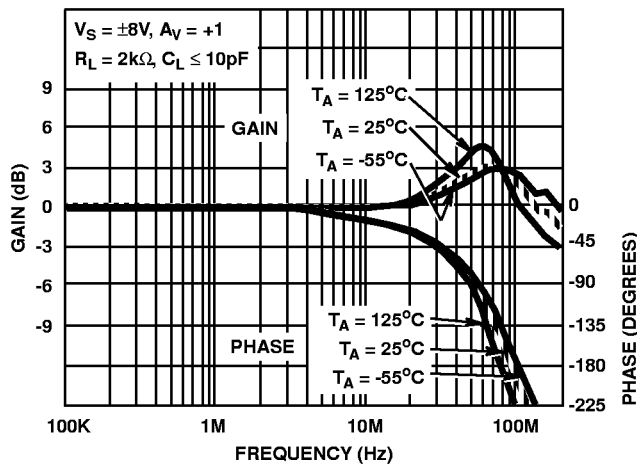

FIGURE 19. CLOSED LOOP FREQUENCY RESPONSE

HA-2541

Die Characteristics

DIE DIMENSIONS:

80 mils x 90 mils x 19 mils
2020 μ m x 2280 μ m x 483 μ m

METALLIZATION:

Type: Al, 1% Cu
Thickness: 16k \AA \pm 2k \AA

PASSIVATION:

Type: Nitride(Si₃N₄) over Silox (SiO₂, 5% Phos.)
Silox Thickness: 12k \AA \pm 2k \AA
Nitride Thickness: 3.5k \AA \pm 1.5k \AA

SUBSTRATE POTENTIAL (Powered Up):

V-

TRANSISTOR COUNT:

41

PROCESS:

Bipolar Dielectric Isolation

Metallization Mask Layout

