

A

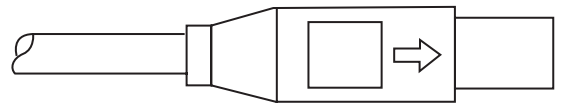
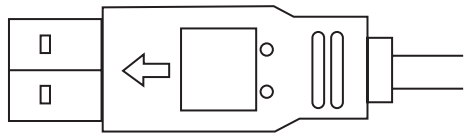

A

B

B

C

C

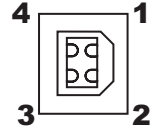
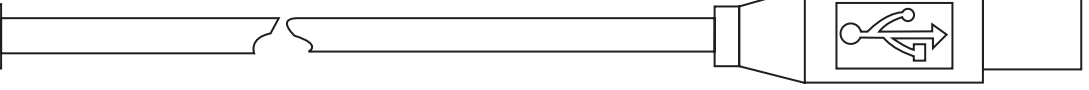
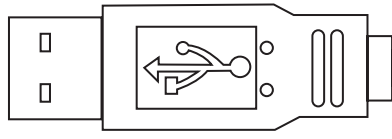
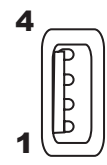

**(P1) USB A Plug**

**(P2) USB B Plug**

**5,000MM±50MM**

USB Configuration

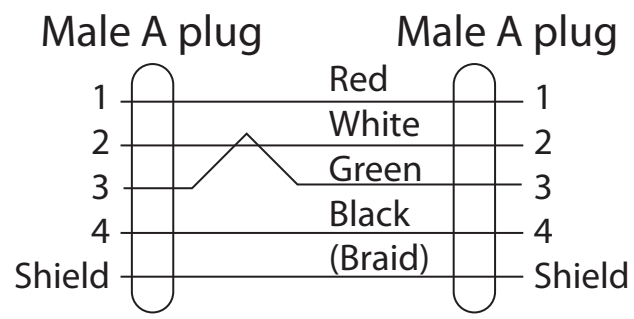

**Material:**

- Cable: #28x1P+#24x2C+AL/MY+1+Braid, UL2725
- Ø4.7MM
- Black PVC

- P1 Connector: USB Male A plug
- P2 Connector: USB Male B plug
- Molded Type

**Electrical:**

- 100% Short, Open, Miswire Test

E

E

F

F

G

G

H

H



Scale	1:1						Name
TOLERANCE						Drawn	08.29.11
X.X	±0.40					Approved	Chappell
X.XX	±0.25						
X.XXX	±0.15						
Angle	±3°	③					
		②					
		①	Modification	Date	Name		



Item No.	
<b>AK672/2-5-BLACK-R</b>	
Title USB 1.1 Cable - Male A <=> Male B, Black, 5 Meters	
Drawing No.	
Replace	Sheet