

A

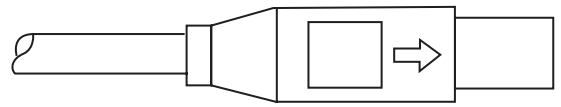
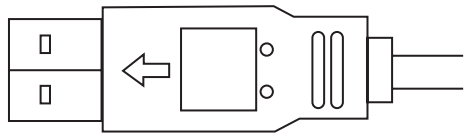

A

B

B

C

C

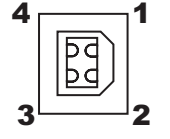
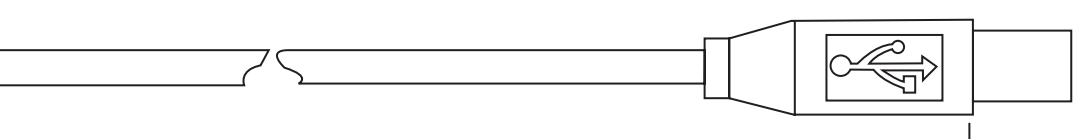
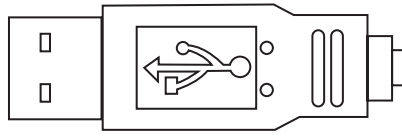
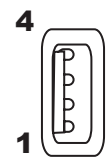

(P1) USB A Plug

(P2) USB B Plug

2,000MM±50MM

USB Configuration

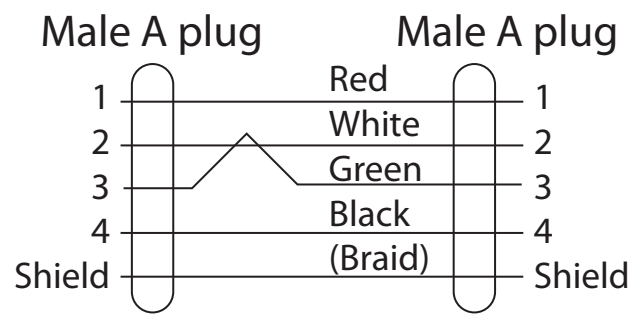

Material:

- Cable: #28x1P+#24x2C+AL/MY+1+Braid, UL2725
- Ø4.7MM
- Black PVC

- P1 Connector: USB Male A plug
- P2 Connector: USB Male B plug
- Molded Type

Electrical:

- 100% Short, Open, Miswire Test

E

E

F

F

G

G

H

H



| | | | | | | | |
|-----------|-------|---|--------------|------|------|----------|----------|
| Scale | 1:1 | | | | | | Name |
| TOLERANCE | | | | | | Drawn | 08.29.11 |
| X.X | ±0.40 | | | | | Chappell | |
| X.XX | ±0.25 | | | | | Approved | |
| X.XXX | ±0.15 | | | | | | |
| Angle | ±3° | ③ | | | | | |
| | | ② | | | | | |
| | | ① | Modification | Date | Name | | |



| | | |
|--|-------|------------------------|
| Item No. | | AK672-2-BLACK-R |
| Title USB 1.1 Cable - Male A <=> Male B, Black, 2 Meters | | |
| Drawing No. | | |
| Replace | Sheet | |