

Cover

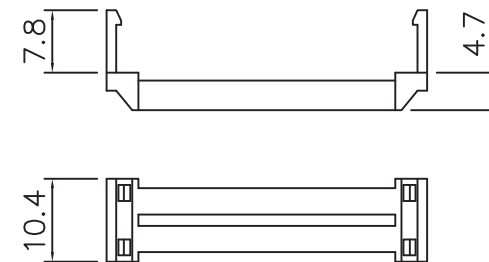
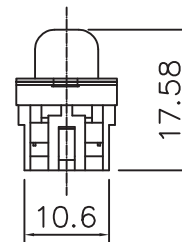
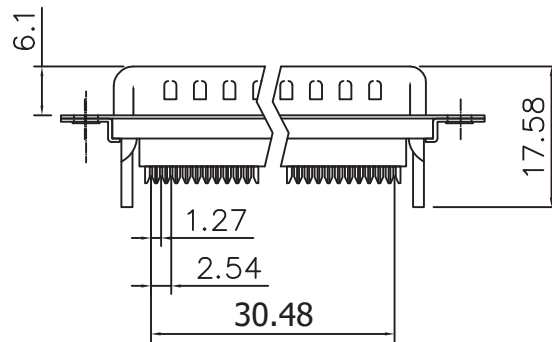

Without Insulator Support

Strain Relief

Material:

- Insulator: Glass-Filled Thermoplastic PBT, UL94V-0
- Contact: Copper alloy
- Shell: Steel, 100µ" Tin Over 50µ" min Copper

Electrical:

- Contact Resistance: 20MΩ Max. @1Amp DC
- Insulation Resistance: 1,000MΩ @500V DC
- Dielectric Withstanding Voltage: 1,000V AC/rms 60Hz for 1 Min.
- Current Rating: 3 Amp
- Voltage Rating: 250V AC/rms 60Hz

*Important is that the min mating cycles D-sub must have are 1,000

Unit: MM±0.25MM



ITEM NO.	A-DSF25LPXX-III-R
TITLE	Flat Ribbon Cable D-Sub Assembly - 25Pin, Male, Low Profile

ASSMANN
Electronics, Inc.

1840 W. Drake Drive, Suite 101 • Tempe, AZ 85283
Toll Free: 1-877-277-6266 • Email: info@usa-assmann.com

THIS DRAWING IS UNPUBLISHED
©Copyright 2010 by Assmann Electronic Components
All International Rights Reserved