

REV.	DATE	ECR NO.	DESCRIPTION
NC	02/04/09	-	INITIAL RELEASE

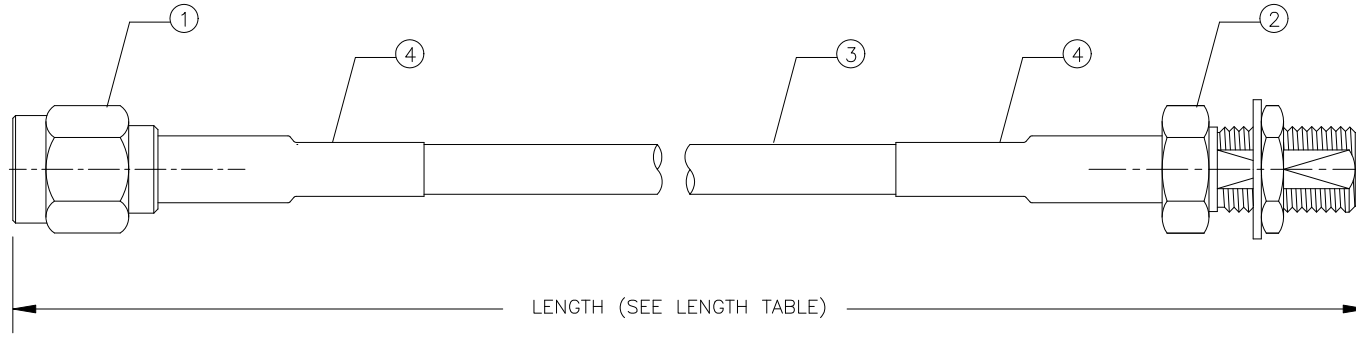

LENGTH TABLE	
PART NUMBER	LENGTH (IN.)
135110-02-06.00	6.00
135110-02-12.00	12.00
135110-02-24.00	24.00
135110-02-36.00	36.00

NOTE:

- PERFORM CONTINUITY AND HI-POT TESTING.
- PACKAGED INDIVIDUALLY IN HEAT SEALED POLY BAG.

PN	DESCRIPTION	QTY
4 009-954-341	HEAT SHRINK TUBING, BLACK, 3/16" DIAMETER	A/R FT
3 009-881-159	COAXIAL CABLE, RG174/U	A/R FT
2 132119	CONNECTOR, SMA BULKHEAD JACK, GOLD	1
1 132114	CONNECTOR, SMA STRAIGHT PLUG, GOLD	1

UNLESS OTHERWISE SPECIFIED DIMENSIONS ARE IN MILLIMETERS. DIMENSIONS IN [] ARE IN INCHES AND FOR CUSTOMER REFERENCE ONLY.

UNLESS OTHERWISE SPECIFIED TOLERANCES FOR MILLIMETERS ARE:
0.5 - 8mm ± 0.20mm
8 - 30mm ± 0.40mm
30 - 120mm ± 0.50mm

UNLESS OTHERWISE SPECIFIED TOLERANCES FOR INCHES ARE:
.020 - .315 = ± 0.007"
.315 - 1.180 = ± 0.015"
1.180 - 4.724 = ± 0.020"

DO NOT SCALE DRAWING

APPROVALS	DATE
DRAWN G.R.S.	02/04/09
CHECKED	
ISSUED	
SHEET 1 OF 1	
CAD FILE	C:/135/135110-02-XX.XX.DWG

Amphenol Connex			
PART DESCRIPTION SMA CABLE ASSEMBLY STRAIGHT PLUG TO BULKHEAD JACK, RG174/U			
PART NO. 135110-02-XX.XX			
DWG. NO.	135110-02-XX.XX.DWG	REV. NC	SIZE A
		SCALE	NA