

REV.	DATE	DESCRIPTION
NC	09/07/99	INITIAL RELEASE
A	07/21/05	UPDATE DRAWING FORMAT

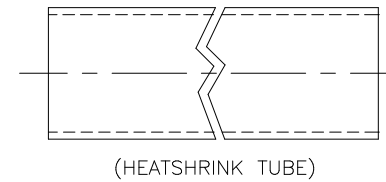
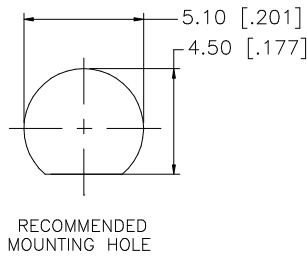
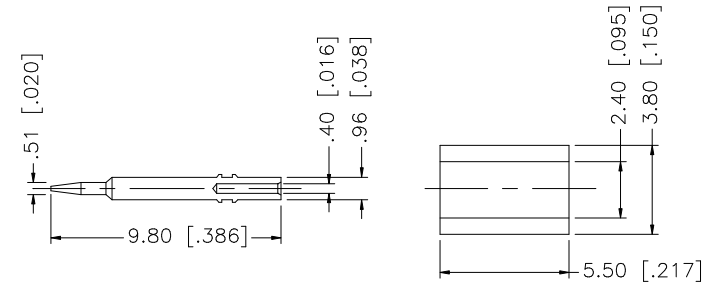
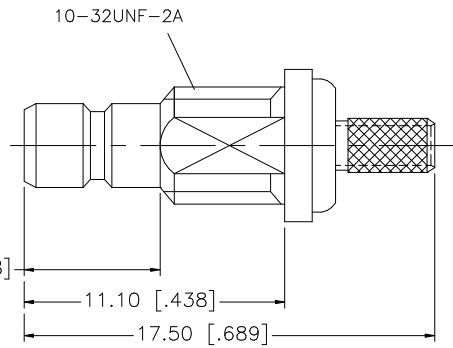
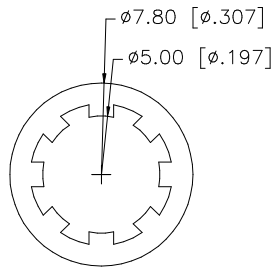
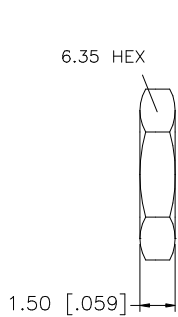
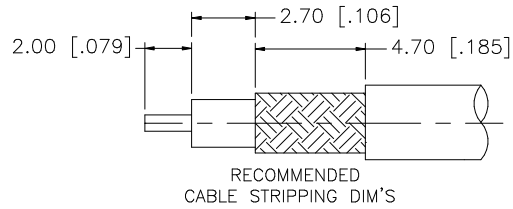

QTY	DESCRIPTION	MATERIAL	FINISH	QTY	UNLESS OTHERWISE SPECIFIED DIMENSIONS ARE IN MILLIMETERS. DIMENSIONS IN [] ARE IN INCHES AND FOR CUSTOMER REFERENCE ONLY.	APPROVALS	DATE	Amphenol Connex					
1	HEAT SHRINK TUBE			1	UNLESS OTHERWISE SPECIFIED TOLERANCES FOR MILLIMETERS ARE: 0.5 - 8mm ± 0.20mm 8 - 30mm ± 0.40mm 30 - 120mm ± 0.50mm	DRAWN	G.R.S.	07/21/05	PART DESCRIPTION SMB BULKHEAD CRIMP JACK (FOR RG-178B/U, 196A/U CABLE)				
1	FERRULE	COPPER	GOLD	1		CHECKED							
1	HEX NUT	BRASS	GOLD	1		ISSUED							
1	LOCK WASHER	BRASS	GOLD	1	UNLESS OTHERWISE SPECIFIED TOLERANCES FOR INCHES ARE: .020 - .315 = ± 0.007" .315 - 1.180 = ± 0.015" 1.180 - 4.724 = ± 0.020"	SHEET	1 OF 1		PART NO. 142231				
1	CONTACT PIN	BRASS	GOLD	1					DWG. NO. 1421231.DWG				
1	INSULATOR	TEFLON	NATURAL	1					REV.	A	SIZE	A	SCALE
1	BODY	BRASS	GOLD	1	DO NOT SCALE DRAWING	CAD FILE	C:/142/142231.DWG						