

CONFIGURATION	PART NUMBER	CONTACT TYPE
STRAIGHT PLUG, 9 POSITION	MB1CKN0900	SOCKET

DIMENSIONS

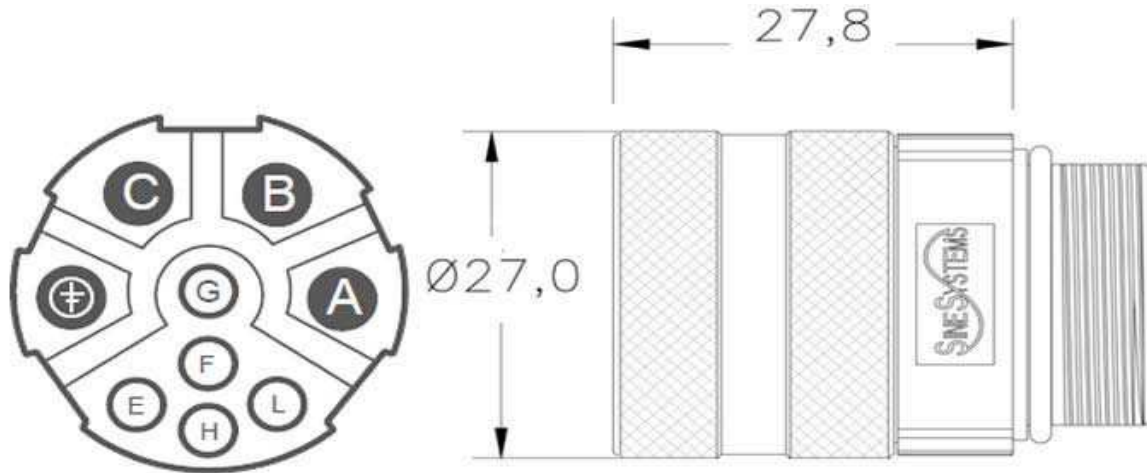

TECHNICAL DATA

TEMPERATURE RANGE:	-20C to +130C
PROTECTION:	IP 67 (PLUGGED CONDITION)
DEGREE OF PROTECTION:	3
OVERVOLTAGE CATEGORY:	III
HOUSING BODY:	ZINC DIE-CAST
COUPLING NUT:	BRASS, NICKEL-PLATED
INSULATION INSERTS:	PA66 / PBT, UL94 / VO
CONTACTS:	BRASS, GOLD-PLATED
SEALS:	DUPONT VITON
MAX CURRENT:	30A
CONTACT SIZE:	4 x 2.0mm / 5 x 1.0mm
MAXIMUM VOLTAGE:	630AC/DC
CONTACT RESISTANCE:	<3
TEST VOLTAGE: (BETWEEN CONTACTS)	6000V
MAXIMUM MATING CYCLES:	>50

NOTES