

CONFIGURATION	PART NUMBER	LENGTH
Straight Receptacle, 6 Pos	MC1LKN0600	NA

## DIMENSIONS

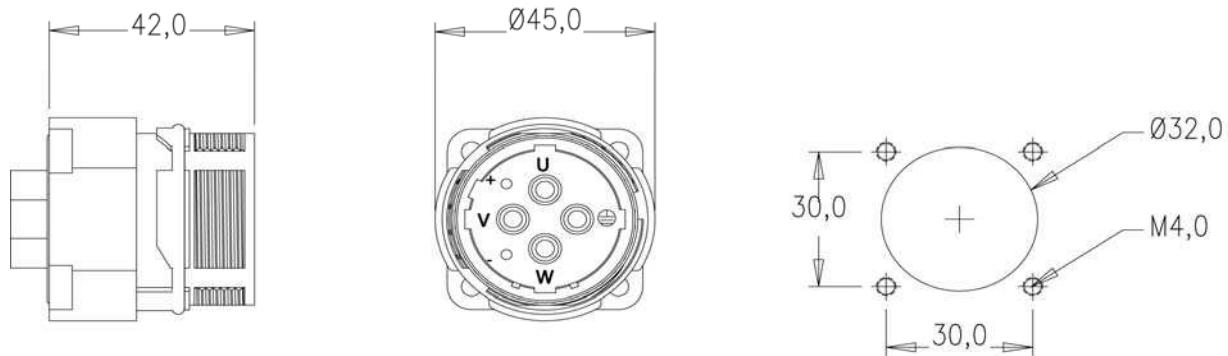

## TECHNICAL DATA

<b>TEMPERATURE RANGE:</b>	-20C to +130C
<b>PROTECTION:</b>	IP 67 (Plugged Condition)
<b>DEGREE OF PROTECTION:</b>	3
<b>OVER VOLTAGE CATEGORY:</b>	III
<b>HOUSING BODY:</b>	ZINC DIE-CAST
<b>COUPLING NUT:</b>	BRASS, NICKEL-PLATED
<b>INSULATION INSERTS:</b>	PA66 / PBT, UL 94 / VO
<b>CONTACTS:</b>	BRASS, GOLD-PLATED
<b>SEALS:</b>	DUPONT VITON
<b>MAX CURRENT:</b>	MAX. 75A
<b>CONTACT SIZE:</b>	4 x 3.6mm / 2 x 2.0mm
<b>MAXIMUM VOLTAGE:</b>	630V AC/DC
<b>CONTACT RESISTANCE:</b>	<1
<b>TEST VOLTAGE:</b>	6000V
<b>(BETWEEN CONTACTS)</b>	
<b>MAXIMUM MATING CYCLES:</b>	>50