

BOCARD

Modular Control Enclosure System



For Finishing Services, Product Support, or to Order

Call 1-301-696-9800



Bocard

Modular enclosure system
which adapts perfectly
to almost every requirement

- 8 sizes
- UL 94 V0 types on request
- 6 different fronts
- Optional terminal compartment, flexible positioning, separable
- Comprehensive range of accessories allows versatile applications



Color	Graphite grey, similar to RAL 7024; light grey, similar to RAL 7035; special colours on request
Protection class	Up to IP 65/DIN EN 60529, depending on the model
Enclosure material	ABS, PC; seal: CR; UL 94 V0 types on request; for details see Technical Information.

Depending on the model, the enclosures are available in RAL 7035, RAL 7024, or two colours can be combined.

To simplify choice, there is a selection of possible enclosure configurations in the following Bocard enclosure variants chapter. The variants are listed in two colour combinations: lid and base in light grey, and light grey base with a graphite grey lid. Of course, we can also supply these combinations completely in graphite grey.

If these complete sets are ordered, delivery is in the form of individual components. We also offer complete assembly on request. The separate enclosure components are listed after the configurations in order to combine individual variants. Detailed information on the individual enclosure components can be found on the following pages.

The range of accessories allows the enclosures to be used as wall-mounted, desktop, console, DIN rail or mobile enclosures.

Wall-mounting is by means of the integrated 4-point wall fitting or with WL wall brackets (accessories).

Fitting onto a top hat rail DIN EN 60715 TH is possible by means of the DIN rail holder up to size BCD 250 (accessories).

In combination with the WB wall-mounting fastening bracket (accessories), the enclosure can be used as an angled wall-mounted or console unit. The snap-on, swivelling handle can also be used for console applications.

Adaptable handle elements for use as a mobile enclosure are available for sizes BCD 160 – 250.





UT-0.5: The flat bases in combination with the membrane lid are ideal for use as mobile operating devices. For ergonomic handling, additional handle elements can be fitted on the rear and also cover the existing mounting openings. The fixing contours for the hinged lid which are moulded onto the base are also concealed by the cover (enclosed).

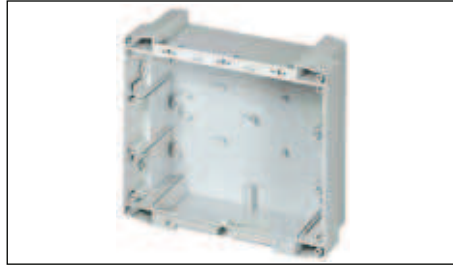

UT: All bases have plug-in slots and fixing domes for circuit boards, mounting panels or DIN rails. As an option, a variable terminal compartment can be integrated and isolated from the electronics compartment. The external surfaces have no pre-punchings, so individual arrangement of cable entries or connections is possible. Depending on the installation side which is used, fitted cable glands are partially concealed.



OT-G: This lid consists of a crystal-clear lid with a frame in light grey or graphite grey which contains the hinge and the snap-lock mechanism.

The OT-FSC lid consists of a membrane lid in light grey or graphite grey and has a recessed area for the fitting of membrane keypads. Both types can be opened to more than 180°, with an intermediate detent position of more than 90°. This prevents the open lid from closing in an uncontrolled manner. The catch is not necessary for manual opening. Alternatively, the blind plug can be inserted to improve the appearance (catch and blind plug are included in the scope of delivery). If the catch is used, the enclosure can only be opened with a tool (slotted-head screwdriver). A cylinder lock (accessories) can also be fitted as an option.

Protection class: IP 65.



UT-F: This plain membrane lid has a recessed area for mounting membrane keypads. Use screws to fit the base. Mounting bosses underneath allow the mounting of circuit boards or mounting panels. A separate terminal compartment can be created using partitions. Ingress protection: IP 65.



FO-K: The FO-K frame is used for edge covering of a front panel (FP...K) and a terminal compartment. The integrated terminal compartment lid has a 1.5 mm recessed area for the fitting of membrane keypads. The frame is pushed onto the base, pressed tight in 2 places, and screwed to the terminal compartment. In connection with base and front panel: protection class IP 40.



FO: The FO frame is used for edge covering of a continuous front panel (FP). Mounting on the base is by clipping-on and pressing tight. In connection with base and front panel: protection class IP 40.

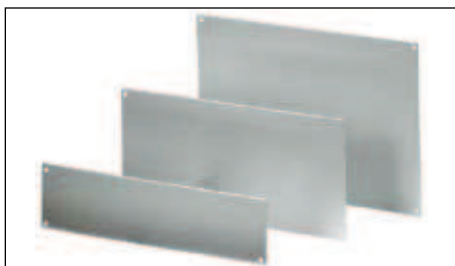

FP: Front panel, aluminium or plastic. The FP...K version must be used for enclosures with a terminal compartment, and the FP...BK version for enclosures with two terminal compartments.

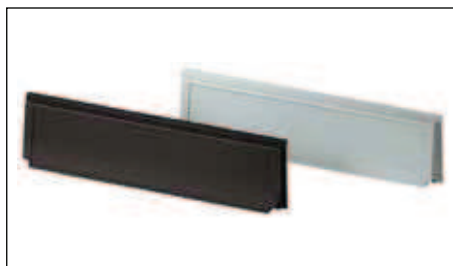

KRD: By using partitions and front panels, a terminal compartment can be created and closed on the front with the KRD. The terminal compartment can be positioned as required on the locking or hinged side or on both sides at the same time. Mounting of the KRD is by hooking in and screwing. The terminal compartment lid is available in light or graphite grey. The KRD is mounted inside the sealed area, so the protection class is retained. The terminal compartment lid has a recessed area for the mounting of membrane keypads.



TP-F: Laminated paper partition for sealing off the electronics compartment if a membrane lid is required in connection with a terminal compartment.

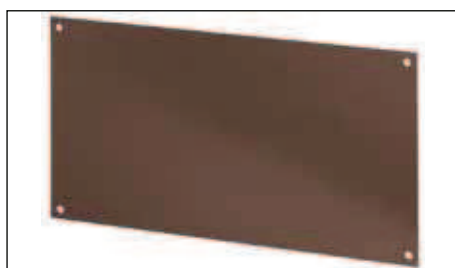

Laminated paper panel for dividing a terminal compartment. The partition is inserted and fixed using TP-F or front panel.



The wall-mounting fastening bracket (WB) is made of powder-coated sheet steel. It is screwed on the rear to the base. Easy wall fitting is guaranteed. As an alternative, with the help of this bracket the Bocard can also be used as a console enclosure.



The swivelling handle (fixed lock-in position every 15°) permits use as both a carrying and set-up bow for desktop application. Anti-slip elements are fitted to the side sections of the handle, ensuring non-slip properties and stability.



Welcome to BOPLA City!



With the swivelling BCD...UWB wall fitting, an enclosure with a flat base can be mounted on a wall in its optimal position.



CF: The installation area has a recessed section for mounting membrane keypads. It can be screwed to a rear panel with four screws. Ingress protection IP 65 to the installation front can be achieved with the optional seal. Cannot be combined with Bocard bases.

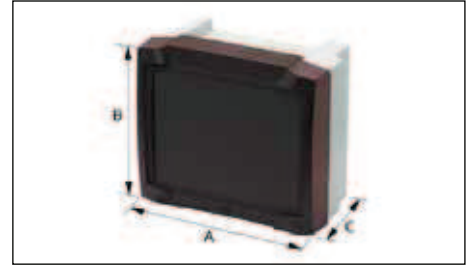

Size information for the complete sets.

Bocard overview:

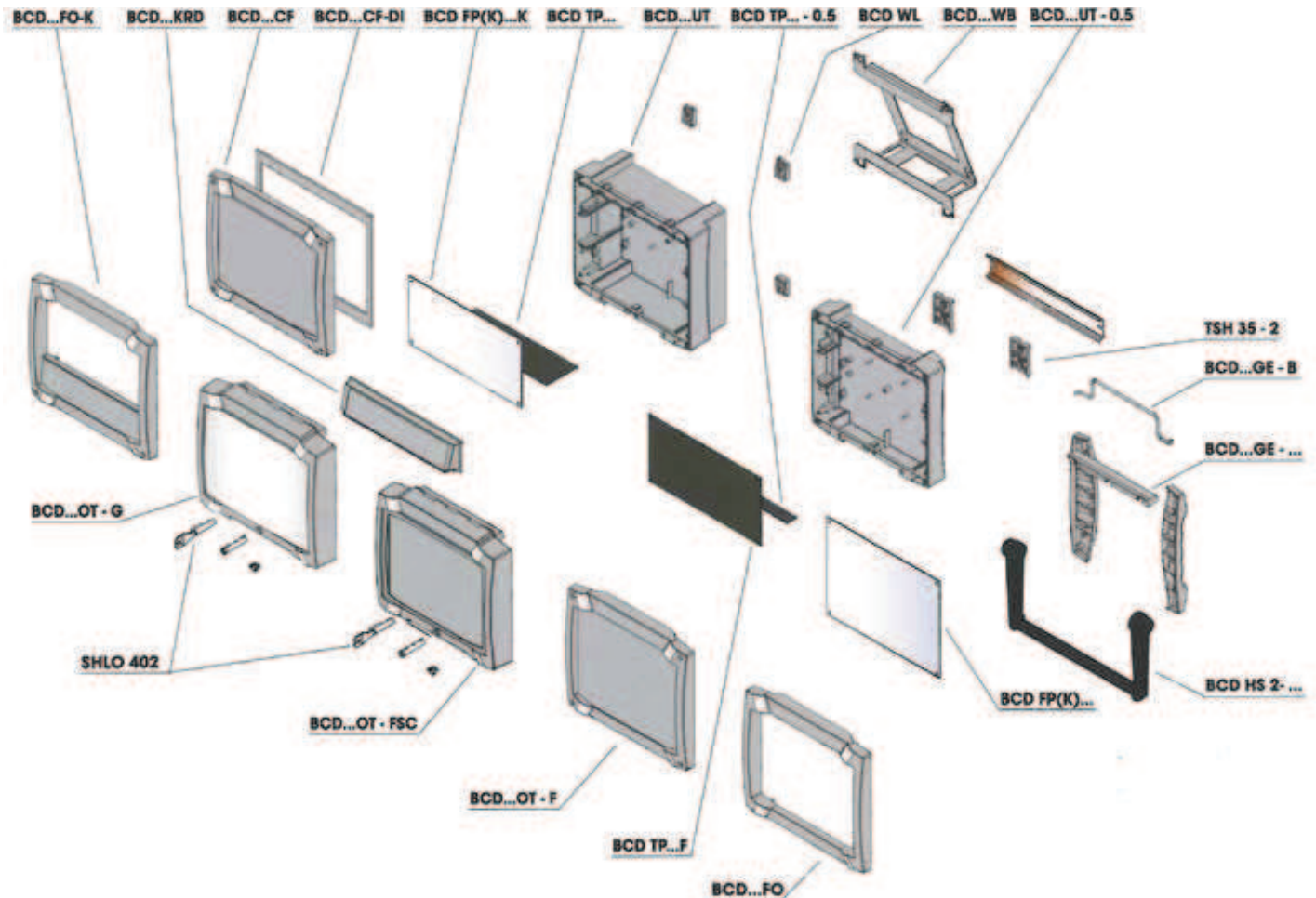

Bocard enclosure variants

High enclosure, with crystal-clear hinged lid, without terminal compartment, IP 65

Model	Order no.	A	B	C
BCD 160 Set 01-7035	20163501	179	199	106,5
BCD 200 Set 01-7035	20203501	204	229	116
BCD 250 Set 01-7035	20253501	234	264	141
BCD 310 Set 01-7035	20313501	289	324	145,2
BCD 400 Set 01-7035	20403501	344	404	160,5

Scope of delivery: 1 x BCD... UT-7035, 1 x BCD... OT-G-7035

Colour combination: Base light grey, lid frame light grey

Note: See following pages for accessories.



High enclosure, with crystal-clear hinged lid, without terminal compartment, IP 65

Model	Order no.	A	B	C
BCD 160 Set 01-7024	20162401	179	199	106,5
BCD 200 Set 01-7024	20202401	204	229	116
BCD 250 Set 01-7024	20252401	234	264	141
BCD 310 Set 01-7024	20312401	289	324	145,2
BCD 400 Set 01-7024	20402401	344	404	160,5

Scope of delivery: 1 x BCD... UT-7035, 1 x BCD... OT-G-7024

Colour combination: Base light grey, lid frame graphite grey

Note: See following pages for accessories.

Flat enclosure, with crystal-clear hinged lid, without terminal compartment, IP 65

Model	Order no.	A	B	C
BCD 160 Set 02-7035	20163502	179	199	71,5
BCD 200 Set 02-7035	20203502	204	229	76
BCD 250 Set 02-7035	20253502	234	264	86
BCD 310 Set 02-7035	20313502	289	324	111,2
BCD 400 Set 02-7035	20403502	344	404	112

Scope of delivery: 1 x BCD... UT-0,5-7035, 1 x BCD... OT-G-7035

Colour combination: Base light grey, lid frame light grey

Note: See following pages for accessories.



Flat enclosure, with crystal-clear hinged lid, without terminal compartment, IP 65

Model	Order no.	A	B	C
BCD 160 Set 02-7024	20162402	179	199	71,5
BCD 200 Set 02-7024	20202402	204	229	76
BCD 250 Set 02-7024	20252402	234	264	86
BCD 310 Set 02-7024	20312402	289	324	111,2
BCD 400 Set 02-7024	20402402	344	404	112

Scope of delivery: 1 x BCD... UT-0,5-7035, 1 x BCD... OT-G-7024

Colour combination: Base light grey, lid frame graphite grey

Note: See following pages for accessories.

Bocard enclosure variants



High enclosure, with crystal-clear hinged lid, for 1 terminal compartment, IP 65

Model	Order no.	A	B	C
BCD 160 Set 03-7035	20163503	179	199	106,5
BCD 200 Set 03-7035	20203503	204	229	116
BCD 250 Set 03-7035	20253503	234	264	141
BCD 310 Set 03-7035	20313503	289	324	145,2
BCD 400 Set 03-7035	20403503	344	404	160,5

Scope of delivery: 1 x BCD... UT-7035, 1 x BCD... OT-G-7035, 1 x BCD... KRD-7035

Colour combination: Base light grey, lid frame light grey

Note: See following pages for accessories.

High enclosure, with crystal-clear hinged lid, for 1 terminal compartment, IP 65

Model	Order no.	A	B	C
BCD 160 Set 03-7024	20162403	179	199	106,5
BCD 200 Set 03-7024	20202403	204	229	116
BCD 250 Set 03-7024	20252403	234	264	141
BCD 310 Set 03-7024	20312403	289	324	145,2
BCD 400 Set 03-7024	20402403	344	404	160,5

Scope of delivery: 1 x BCD... UT-7035, 1 x BCD... OT-G-7024, 1 x BCD... KRD-7024

Colour combination: Base light grey, lid frame graphite grey

Note: See following pages for accessories.



Flat enclosure, with crystal-clear hinged lid, for 1 terminal compartment, IP 65

Model	Order no.	A	B	C
BCD 160 Set 04-7035	20163504	179	199	71,5
BCD 200 Set 04-7035	20203504	204	229	76
BCD 250 Set 04-7035	20253504	234	264	86
BCD 310 Set 04-7035	20313504	289	324	111,2
BCD 400 Set 04-7035	20403504	344	404	112

Scope of delivery: 1 x BCD... UT-0,5-7035, 1 x BCD... OT-G-7035, 1 x BCD... KRD-7035

Colour combination: Base light grey, lid frame light grey

Note: See following pages for accessories.

Flat enclosure, with crystal-clear hinged lid, for 1 terminal compartment, IP 65

Model	Order no.	A	B	C
BCD 160 Set 04-7024	20162404	179	199	71,5
BCD 200 Set 04-7024	20202404	204	229	76
BCD 250 Set 04-7024	20252404	234	264	86
BCD 310 Set 04-7024	20312404	289	324	111,2
BCD 400 Set 04-7024	20402404	344	404	112

Scope of delivery: 1 x BCD... UT-0,5-7035, 1 x BCD... OT-G-7024, 1 x BCD... KRD-7024

Colour combination: Base light grey, lid frame graphite grey

Note: See following pages for accessories.

Bocard enclosure variants

High enclosure, with crystal-clear hinged lid, for 2 terminal compartments, IP 65

Model	Order no.	A	B	C
BCD 160 Set 05-7035	20163505	179	199	106,5
BCD 200 Set 05-7035	20203505	204	229	116
BCD 250 Set 05-7035	20253505	234	264	141
BCD 310 Set 05-7035	20313505	289	324	145,2
BCD 400 Set 05-7035	20403505	344	404	160,5

Scope of delivery: 1 x BCD... UT-7035, 1 x BCD... OT-G-7035, 2 x BCD... KRD-7035

Colour combination: Base light grey, lid frame light grey

Note: See following pages for accessories.



High enclosure, with crystal-clear hinged lid, for 2 terminal compartments, IP 65

Model	Order no.	A	B	C
BCD 160 Set 05-7024	20162405	179	199	106,5
BCD 200 Set 05-7024	20202405	204	229	116
BCD 250 Set 05-7024	20252405	234	264	141
BCD 310 Set 05-7024	20312405	289	324	145,2
BCD 400 Set 05-7024	20402405	344	404	160,5

Scope of delivery: 1 x BCD... UT-7035, 1 x BCD... OT-G-7024, 2 x BCD... KRD-7024

Colour combination: Base light grey, lid frame graphite grey

Note: See following pages for accessories.

Flat enclosure, with crystal-clear hinged lid, for 2 terminal compartments, IP 65

Model	Order no.	A	B	C
BCD 160 Set 06-7035	20163506	179	199	71,5
BCD 200 Set 06-7035	20203506	204	229	76
BCD 250 Set 06-7035	20253506	234	264	86
BCD 310 Set 06-7035	20313506	289	324	111,2
BCD 400 Set 06-7035	20403506	344	404	112

Scope of delivery: 1 x BCD... UT-0,5-7035, 1 x BCD... OT-G-7035, 2 x BCD... KRD-7035

Colour combination: Base light grey, lid frame light grey

Note: See following pages for accessories.



Flat enclosure, with crystal-clear hinged lid, for 2 terminal compartments, IP 65

Model	Order no.	A	B	C
BCD 160 Set 06-7024	20162406	179	199	71,5
BCD 200 Set 06-7024	20202406	204	229	76
BCD 250 Set 06-7024	20252406	234	264	86
BCD 310 Set 06-7024	20312406	289	324	111,2
BCD 400 Set 06-7024	20402406	344	404	112

Scope of delivery: 1 x BCD... UT-0,5-7035, 1 x BCD... OT-G-7024, 2 x BCD... KRD-7024

Colour combination: Base light grey, lid frame graphite grey

Note: See following pages for accessories.

Bocard enclosure variants



High enclosure, with open front frame without terminal compartment

Model	Order no.	A	B	C
BCD 160 Set 07-7035	20163507	178	199	89
BCD 200 Set 07-7035	20203507	203	229	99
BCD 250 Set 07-7035	20253507	233	264	124

Scope of delivery: 1 x BCD... UT-7035, 1 x BCD... FO-7035

Colour combination: Base light grey, front frame light grey

Note: See following pages for accessories.

High enclosure, with open front frame without terminal compartment

Model	Order no.	A	B	C
BCD 160 Set 07-7024	20162407	178	199	89
BCD 200 Set 07-7024	20202407	203	229	99
BCD 250 Set 07-7024	20252407	233	264	124

Scope of delivery: 1 x BCD... UT-7035, 1 x BCD... FO-7024

Colour combination: Base light grey, front frame graphite grey

Note: See following pages for accessories.



Flat enclosure, with open front frame, without terminal compartment

Model	Order no.	A	B	C
BCD 160 Set 08-7035	20163508	178	199	54
BCD 200 Set 08-7035	20203508	203	229	59
BCD 250 Set 08-7035	20253508	233	264	69

Scope of delivery: 1 x BCD... UT-0,5-7035, 1 x BCD... FO-7035

Colour combination: Base light grey, front frame light grey

Note: See following pages for accessories.

Flat enclosure, with open front frame, without terminal compartment

Model	Order no.	A	B	C
BCD 160 Set 08-7024	20162408	178	199	54
BCD 200 Set 08-7024	20202408	203	229	59
BCD 250 Set 08-7024	20252408	233	264	69

Scope of delivery: 1 x BCD... UT-0,5-7035, 1 x BCD... FO-7024

Colour combination: Base light grey, lid frame graphite grey

Note: See following pages for accessories.

Bocard enclosure variants

High enclosure, with front frame open, incl. terminal compartment cover, graphite grey

Model	Order no.	A	B	C
BCD 160 Set 09-7035	20163509	178	199	89
BCD 200 Set 09-7035	20203509	203	229	99
BCD 250 Set 09-7035	20253509	233	264	124

Scope of delivery: 1 x BCD... UT-7035, 1 x BCD... FO-K-7035

Colour combination: Base light grey, front frame light grey

Note: See following pages for accessories.



High enclosure, with front frame open, incl. terminal compartment cover, graphite grey

Model	Order no.	A	B	C
BCD 160 Set 09-7024	20162409	178	199	89
BCD 200 Set 09-7024	20202409	203	229	99
BCD 250 Set 09-7024	20252409	233	264	124

Scope of delivery: 1 x BCD... UT-7035, 1 x BCD... FO-K-7024

Colour combination: Base light grey, lid frame graphite grey

Note: See following pages for accessories.

Flat enclosure, with front frame open, incl. terminal compartment cover, graphite grey

Model	Order no.	A	B	C
BCD 160 Set 10-7035	20163510	178	199	54
BCD 200 Set 10-7035	20203510	203	229	59
BCD 250 Set 10-7035	20253510	233	264	69

Scope of delivery: 1 x BCD... UT-0,5-7035, 1 x BCD... FO-K-7035

Colour combination: Base light grey, front frame light grey

Note: See following pages for accessories.



Flat enclosure, with front frame open, incl. terminal compartment cover, graphite grey

Model	Order no.	A	B	C
BCD 160 Set 10-7024	20162410	178	199	54
BCD 200 Set 10-7024	20202410	203	229	59
BCD 250 Set 10-7024	20252410	233	264	69

Scope of delivery: 1 x BCD... UT-0,5-7035, 1 x BCD... FO-K-7024

Colour combination: Base light grey, lid frame graphite grey

Note: See following pages for accessories.

Bocard enclosure variants



High enclosure, with membrane lid, IP 65

Model	Order no.	A	B	C
BCD 160 Set 11-7035	20163511	178	199	89
BCD 200 Set 11-7035	20203511	203	229	99
BCD 250 Set 11-7035	20253511	233	264	124

Scope of delivery: 1 x BCD... UT-7035, 1 x BCD... OT-F-7035

Colour combination: Base light grey, front lid light grey

Note: See following pages for accessories.

High enclosure, with membrane lid, IP 65

Model	Order no.	A	B	C
BCD 160 Set 11-7024	20162411	178	199	89
BCD 200 Set 11-7024	20202411	203	229	99
BCD 250 Set 11-7024	20252411	233	264	124

Scope of delivery: 1 x BCD... UT-7035, 1 x BCD... OT-F-7024

Colour combination: Base light grey, front lid graphite grey

Note: See following pages for accessories.



Flat enclosure, with membrane lid, IP 65

Model	Order no.	A	B	C
BCD 160 Set 12-7035	20163512	178	199	54
BCD 200 Set 12-7035	20203512	203	229	59
BCD 250 Set 12-7035	20253512	233	264	69

Scope of delivery: 1 x BCD... UT-0,5-7035, 1 x BCD... OT-F-7035

Colour combination: Base light grey, front lid light grey

Note: See following pages for accessories.

Flat enclosure, with membrane lid, IP 65

Model	Order no.	A	B	C
BCD 160 Set 12-7024	20162412	178	199	54
BCD 200 Set 12-7024	20202412	203	229	59
BCD 250 Set 12-7024	20252412	233	264	69

Scope of delivery: 1 x BCD... UT-0,5-7035, 1 x BCD... OT-F-7024

Colour combination: Base light grey, front lid graphite grey

Note: See following pages for accessories.

Bocard enclosure variants

High enclosure, with hinged membrane lid, IP 65

Model	Order no.	A	B	C
BCD 160 Set 13-7035	20163513	179	199	106,5
BCD 200 Set 13-7035	20203513	204	229	116
BCD 250 Set 13-7035	20253513	234	264	141
BCD 310 Set 13-7035	20313513	289	324	145,2
BCD 400 Set 13-7035	20403513	344	404	160,5

Scope of delivery: 1 x BCD... UT-7035, 1 x BCD... OT-FSC-7035

Colour combination: Base light grey, front lid light grey

Note: See following pages for accessories.



High enclosure, with hinged membrane lid, IP 65

Model	Order no.	A	B	C
BCD 160 Set 13-7024	20162413	179	199	106,5
BCD 200 Set 13-7024	20202413	204	229	116
BCD 250 Set 13-7024	20252413	234	264	141
BCD 310 Set 13-7024	20312413	289	324	145,2
BCD 400 Set 13-7024	20402413	344	404	160,5

Scope of delivery: 1 x BCD... UT-7035, 1 x BCD... OT-FSC-7024

Colour combination: Base light grey, front lid graphite grey

Note: See following pages for accessories.

Flat enclosure, with hinged membrane lid, IP 65

Model	Order no.	A	B	C
BCD 160 Set 14-7035	20163514	179	199	71,5
BCD 200 Set 14-7035	20203514	204	229	76
BCD 250 Set 14-7035	20253514	234	264	86
BCD 310 Set 14-7035	20313514	289	324	111,2
BCD 400 Set 14-7035	20403514	344	404	112

Scope of delivery: 1 x BCD... UT-0,5-7035, 1 x BCD... OT-FSC-7035

Colour combination: Base light grey, front lid light grey

Note: See following pages for accessories.



Flat enclosure, with hinged membrane lid, IP 65

Model	Order no.	A	B	C
BCD 160 Set 14-7024	20162414	179	199	71,5
BCD 200 Set 14-7024	20202414	204	229	76
BCD 250 Set 14-7024	20252414	234	264	86
BCD 310 Set 14-7024	20312414	289	324	111,2
BCD 400 Set 14-7024	20402414	344	404	112

Scope of delivery: 1 x BCD... UT-0,5-7035, 1 x BCD... OT-FSC-7024

Colour combination: Base light grey, front lid graphite grey

Note: See following pages for accessories.

Bocard bases



Base, high

Model	Order no.	A	B	C	a1	a2	b1	c1	Colour
BCD 160 UT-7035	20160135	195	173	70	189	168,5	141	67	Light grey
BCD 160 UT-7024	20160124	195	173	70	189	168,5	141	67	Graphite grey
BCD 200 UT-7035	20200135	225	198	80	219	198,3	166	77	Light grey
BCD 200 UT-7024	20200124	225	198	80	219	198,3	166	77	Graphite grey
BCD 250 UT-7035	20250135	260	228	105	254	232,8	196	102	Light grey
BCD 250 UT-7024	20250124	260	228	105	254	232,8	196	102	Graphite grey
BCD 310 UT-7035	20310135	320	283	105	312	290,8	243	101	Light grey
BCD 400 UT-7035	20400135	400	338	120	391	369,6	297	115,5	Light grey

Scope of delivery: 1 Base, high

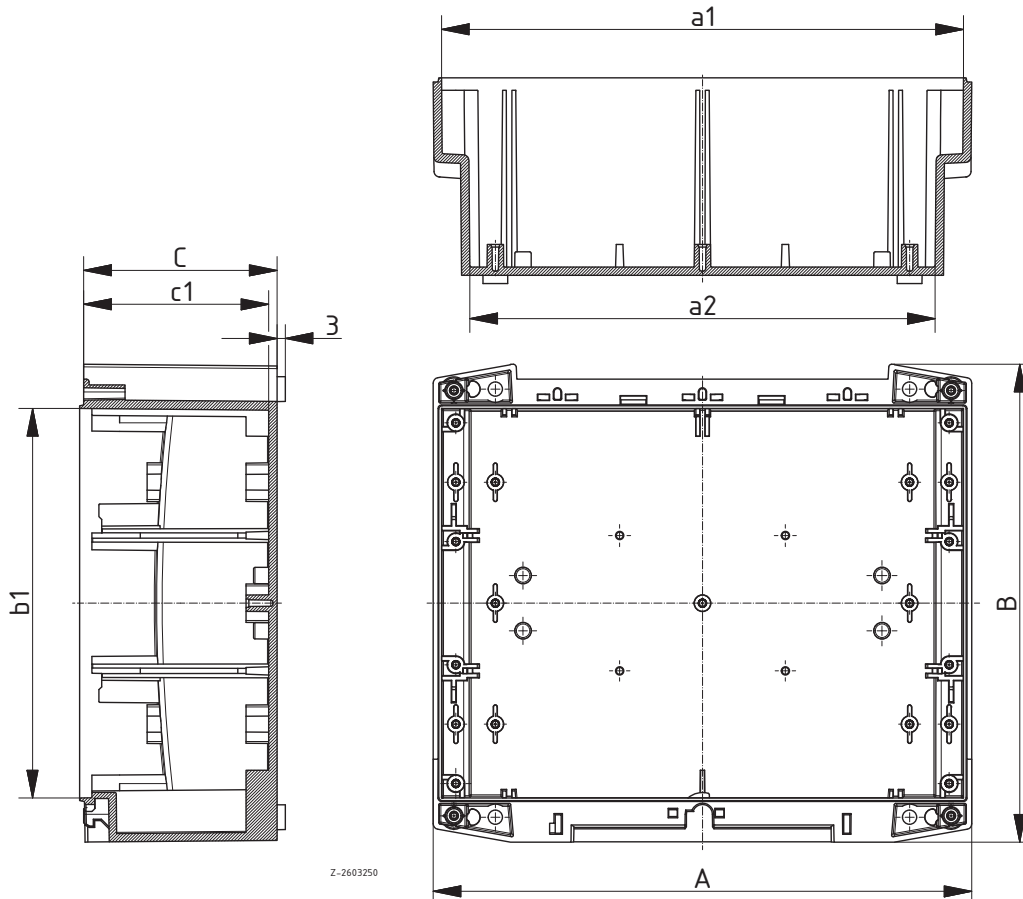

Z-2603250

Bocard bases



Base, flat

Model	Order no.	A	B	C	a1	a2	b1	c1	Colour
BCD 160 UT-0,5-7035	20160235	195	173	35	189	169	141	32	Light grey
BCD 160 UT-0,5-7024	20160224	195	173	35	189	169	141	32	Graphite grey
BCD 200 UT-0,5-7035	20200235	225	198	40	219	199	166	37	Light grey
BCD 200 UT-0,5-7024	20200224	225	198	40	219	199	166	37	Graphite grey
BCD 250 UT-0,5-7035	20250235	260	228	50	254	233,8	196	47	Light grey
BCD 250 UT-0,5-7024	20250224	260	228	50	254	233,8	196	47	Graphite grey
BCD 310 UT-0,5-7035	20310235	320	283	71	312	291,4	243	67	Light grey
BCD 400 UT-0,5-7035	20400235	400	338	71,5	391	370,5	297	67	Light grey

Scope of delivery: 1 Base, flat

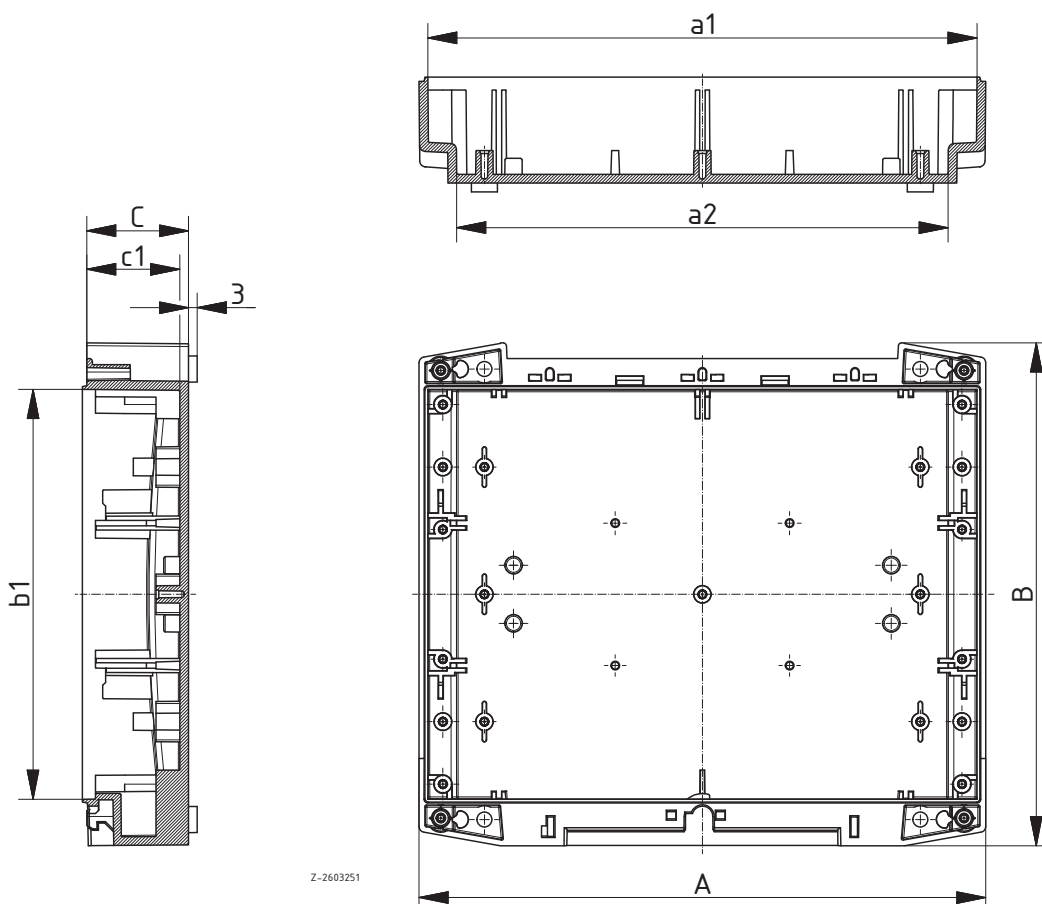

Z-2603251

Bocard lids



Hinged front lid, crystal-clear

Model	Order no.	A	B	C	a1	b1	c1	Colour
BCD 160 OT-G-7035	20161035	199	179,2	36,5	185	137	31	Light grey
BCD 160 OT-G-7024	20161024	199	179,2	36,5	185	137	31	Graphite grey
BCD 200 OT-G-7035	20201035	229	204,2	36,1	215	162	31,8	Light grey
BCD 200 OT-G-7024	20201024	229	204,2	36,1	215	162	31,8	Graphite grey
BCD 250 OT-G-7035	20251035	264	234,2	36	250	192	31,9	Light grey
BCD 250 OT-G-7024	20251024	264	234,2	36	250	192	31,9	Graphite grey
BCD 310 OT-G-7035	20311035	324	289,2	37,2	308	239	31,7	Light grey
BCD 310 OT-G-7024	20311024	324	289,2	37,2	308	239	31,7	Graphite grey
BCD 400 OT-G-7035	20401035	404	344,2	37,5	387	293	31,5	Light grey
BCD 400 OT-G-7024	20401024	404	344,2	37,5	387	293	31,5	Graphite grey

Scope of delivery: 1 front lid, hinged, 1 catch, 1 blind plug

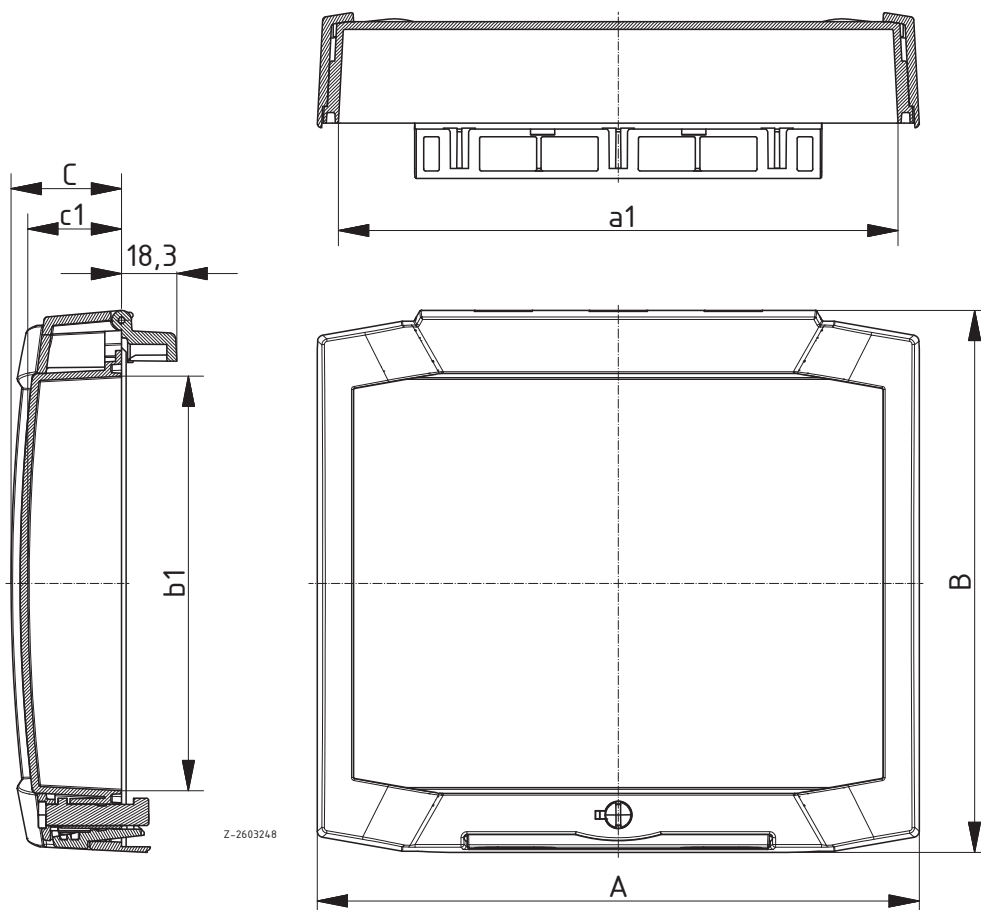

Bocard lids

Hinged front lid with membrane keypad area

Model	Order no.	A	B	C	a1	b1	c1	Colour
BCD 160 OT-FSC-7035	20161535	199	179,2	36,5	185	137	25,7	Light grey
BCD 160 OT-FSC-7024	20161524	199	179,2	36,5	185	137	25,7	Graphite grey
BCD 200 OT-FSC-7035	20201535	229	204,2	36,1	215	162	25,7	Light grey
BCD 200 OT-FSC-7024	20201524	229	204,2	36,1	215	162	25,7	Graphite grey
BCD 250 OT-FSC-7035	20251535	264	234,2	36	250	192	25,7	Light grey
BCD 250 OT-FSC-7024	20251524	264	234,2	36	250	192	25,7	Graphite grey
BCD 310 OT-FSC-7035	20311535	324	289,2	37,2	308	239	25,2	Light grey
BCD 310 OT-FSC-7024	20311524	324	289,2	37,2	308	239	25,2	Graphite grey
BCD 400 OT-FSC-7035	20401535	404	344,2	37,5	387	293	24,7	Light grey
BCD 400 OT-FSC-7024	20401524	404	344,2	37,5	387	293	24,7	Graphite grey

Scope of delivery: 1 front lid, hinged, 1 catch, 1 blind plug

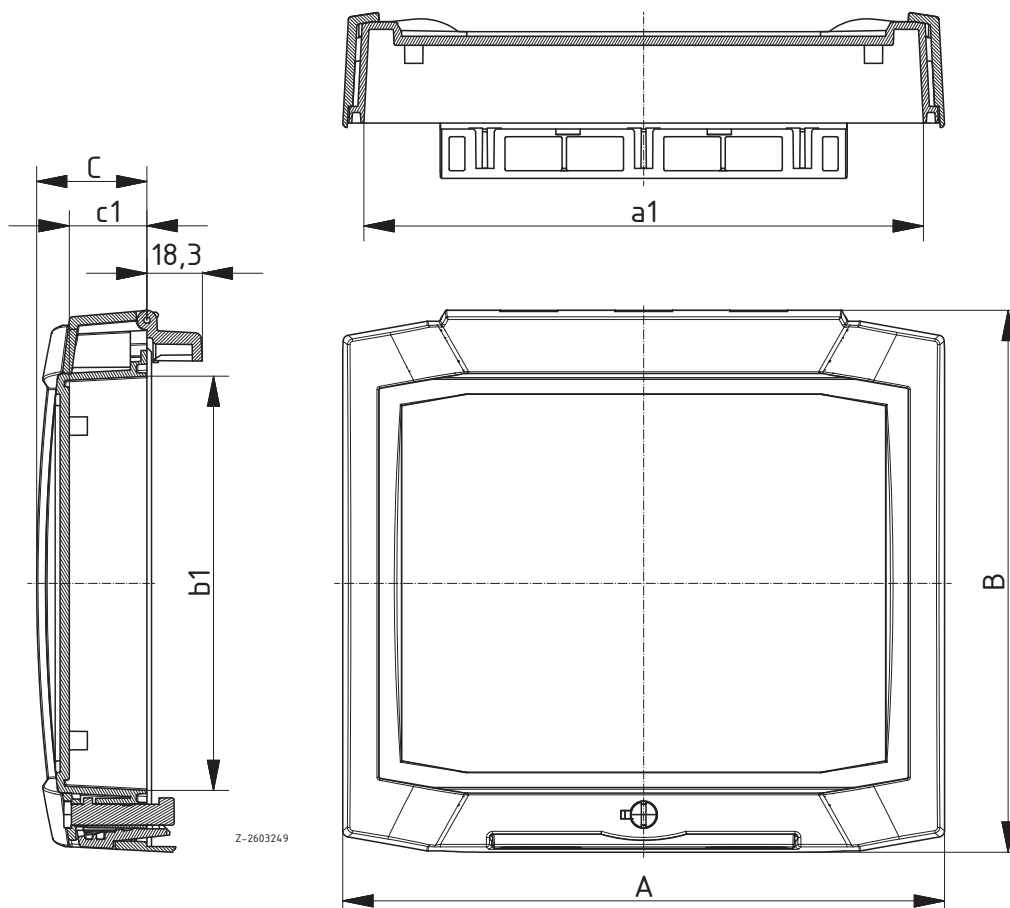

Bocard lids



Screw-on front lid with membrane keypad area

Model	Order no.	A	B	C	a1	b1	Colour
BCD 160 OT-F-7035	20161335	199	177,85	19	171,9	137,9	Light grey
BCD 160 OT-F-7024	20161324	199	177,85	19	171,9	137,9	Graphite grey
BCD 200 OT-F-7035	20201335	229	202,85	18,7	202,2	162,9	Light grey
BCD 200 OT-F-7024	20201324	229	202,85	18,7	202,2	162,9	Graphite grey
BCD 250 OT-F-7035	20251335	264	232,85	18,6	237,5	192,9	Light grey
BCD 250 OT-F-7024	20251324	264	232,85	18,6	237,5	192,9	Graphite grey

Scope of delivery: 1 front lid, screws, screw covers

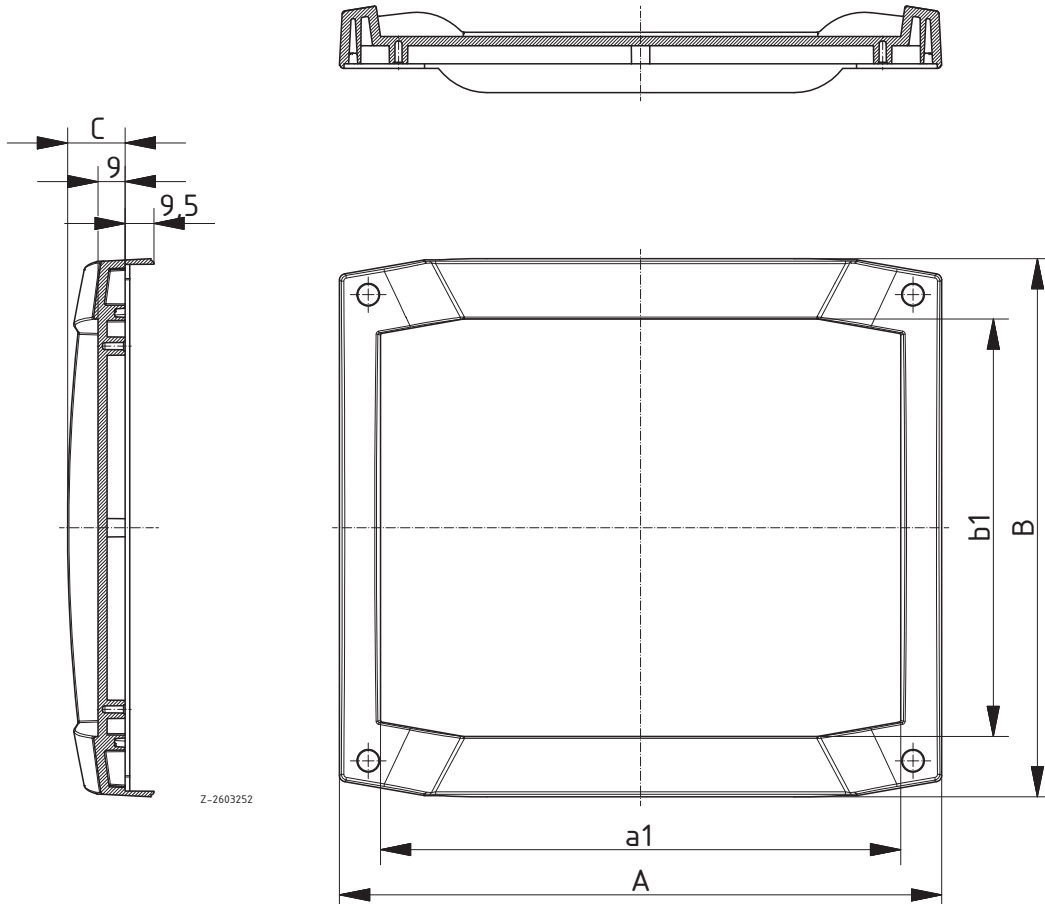

Bocard lids

Screw-on open front frame with terminal compartment cover, screw-on

Model	Order no.	A	B	C	a1	b1	Colour
BCD 160 FO-K-7035	20161235	199	177,85	19	169,3	93,7	Light grey
BCD 160 FO-K-7024	20161224	199	177,85	19	169,3	93,7	Graphite grey
BCD 200 FO-K-7035	20201235	229	202,85	18,7	199,7	108,7	Light grey
BCD 200 FO-K-7024	20201224	229	202,85	18,7	199,7	108,7	Graphite grey
BCD 250 FO-K-7035	20251235	264	232,85	18,6	235	131,7	Light grey
BCD 250 FO-K-7024	20251224	264	232,85	18,6	235	131,7	Graphite grey

Scope of delivery: 1 front frame with terminal compartment cover, screws, screw covers

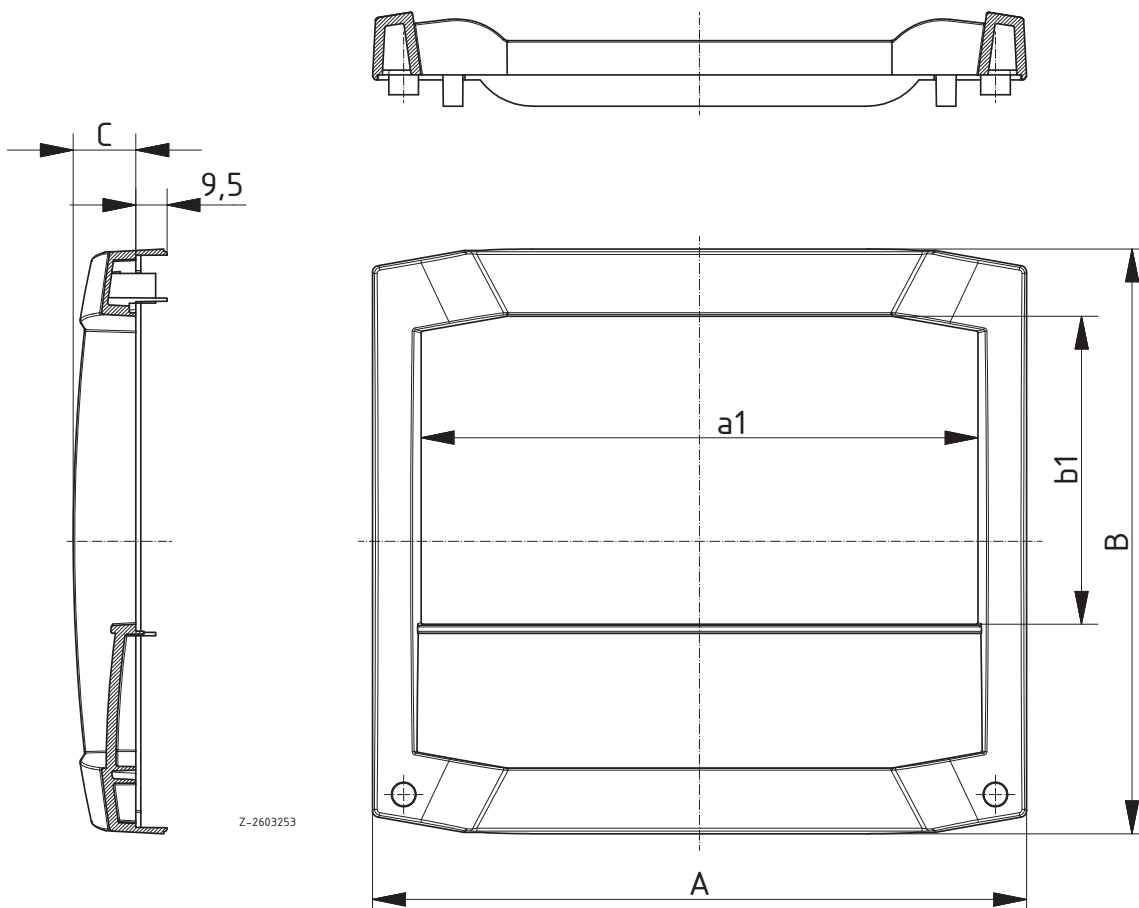

Bocard lids



Open front frame, clip-on

Model	Order no.	A	B	C	a1	b1	Colour
BCD 160 FO-7035	20161135	199	177,85	19	169,3	137	Light grey
BCD 160 FO-7024	20161124	199	177,85	19	169,3	137	Graphite grey
BCD 200 FO-7035	20201135	229	202,85	18,7	199,7	162	Light grey
BCD 200 FO-7024	20201124	229	202,85	18,7	199,7	162	Graphite grey
BCD 250 FO-7035	20251135	264	232,85	18,6	235	192	Light grey
BCD 250 FO-7024	20251124	264	232,85	18,6	235	192	Graphite grey

Scope of delivery: 1 front frame

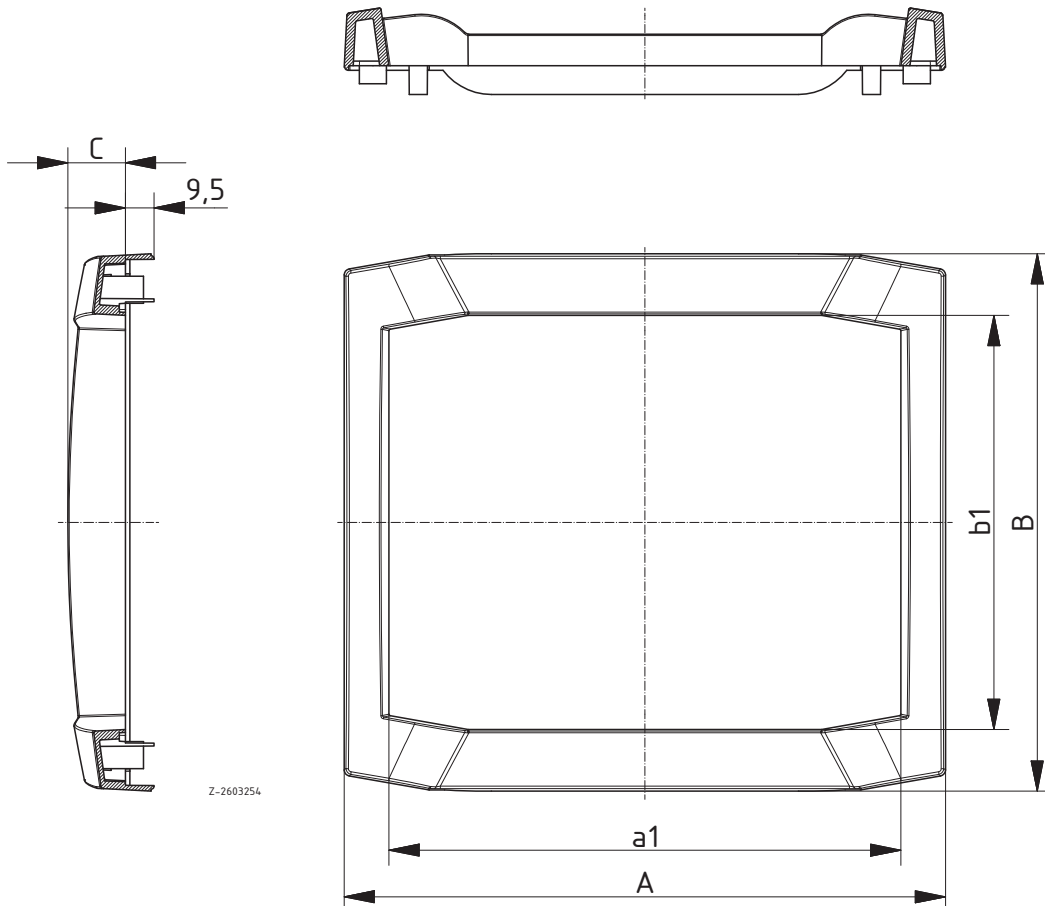

Z-2603254

Bocard installation area

Installation area with membrane keypad area

Model	Order no.	A	B	C	a1	b1	Colour
BCD 160 CF-7035	20161435	199	177,85	19	171,9	137,9	Light grey
BCD 160 CF-7024	20161424	199	177,85	19	171,9	137,9	Graphite grey
BCD 200 CF-7035	20201435	229	202,85	18,7	202,2	162,9	Light grey
BCD 200 CF-7024	20201424	229	202,85	18,7	202,2	162,9	Graphite grey
BCD 250 CF-7035	20251435	264	232,85	18,6	237,5	192,9	Light grey
BCD 250 CF-7024	20251424	264	232,85	18,6	237,5	192,9	Graphite grey

Scope of delivery: 1 installation area, screws, screw covers

Note: Protection class IP 40 towards the control panel wall. Up to protection class IP 65 can be achieved with seal CF-DI (accessory). The CF front cannot be used with Bocard bases.

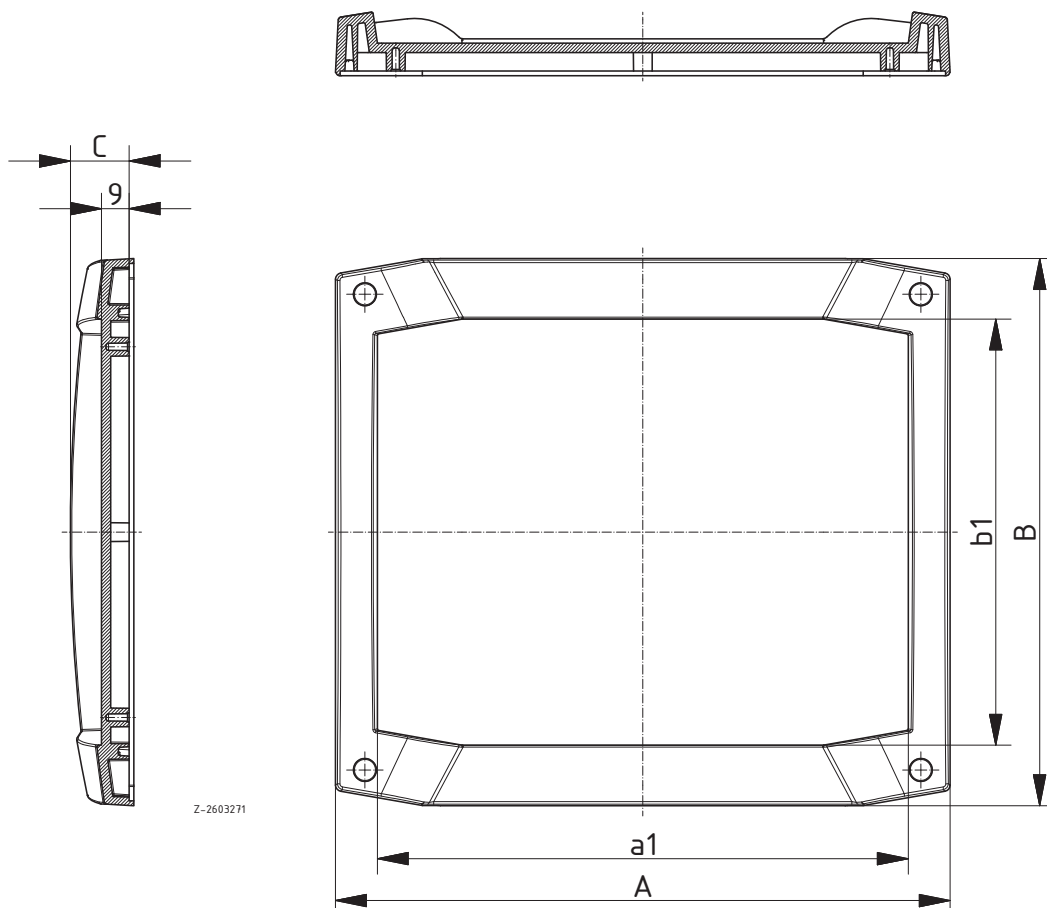

Bocard accessories



Terminal compartment lid with membrane keypad area, screw-on

Model	Order no.	Colour	Note
BCD 160 KRD-7035	20162035	Light grey	For BCD 160
BCD 160 KRD-7024	20162024	Graphite grey	For BCD 160
BCD 200 KRD-7035	20202035	Light grey	For BCD 200
BCD 200 KRD-7024	20202024	Graphite grey	For BCD 200
BCD 250 KRD-7035	20252035	Light grey	For BCD 250
BCD 250 KRD-7024	20252024	Graphite grey	For BCD 250
BCD 310 KRD-7035	20312035	Light grey	For BCD 310
BCD 310 KRD-7024	20312024	Graphite grey	For BCD 310
BCD 400 KRD-7035	20402035	Light grey	For BCD 400
BCD 400 KRD-7024	20402024	Graphite grey	For BCD 400

Scope of delivery: 1 terminal compartment lid, 2 screws

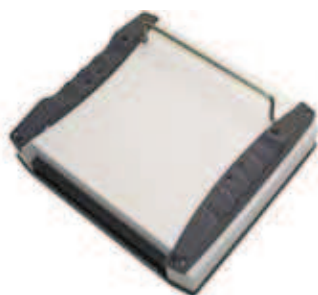

Handle elements, graphite grey plastic

Model	Order no.	Note
BCD 160 GE-7024	20167024	For BCD 160
BCD 200 GE-7024	20207024	For BCD 200
BCD 250 GE-7024	20257024	For BCD 250

Scope of delivery: 2 handle elements, 1 cover for hinge bearing, 8 screws, 6 rubber feet



Tip-up bow for handle element

Model	Order no.	Note
BCD 160 GE-B	20167100	For BCD 160 GE-7024
BCD 200 GE-B	20207100	For BCD 200 GE-7024
BCD 250 GE-B	20257100	For BCD 250 GE-7024

Scope of delivery: 1 tip-up bow



Handle / tip-up bow, hinged

Model	Order no.	Note
BCD 160 HS 2-9005	20008070	For BCD 160
BCD 200 HS 2-9005	20008071	For BCD 200
BCD 250 HS 2-9005	20008072	For BCD 250

Scope of delivery: 2 side parts, 2 anti-slip elements, handle profile, fixing material

Note: BOPLA can carry out the necessary processing of the base with individual adaptation of the position.

Bocard accessories

Wall brackets

Model	Order no.	Colour
BCD WL-7035	20007000	Light grey
BCD WL-7024	20007001	Graphite grey

Scope of delivery: 4 wall brackets, screws

Note: For 4-point wall fixing without opening the enclosure. Fitting to rear of enclosure from the outside. Suitable for all enclosures in this series.



Wall-mounting fastening bracket, powder-coated sheet steel

Model	Order no.	Colour	Note
BCD 160 WB-7035	20008080	Light grey	For BCD 160
BCD 200 WB-7035	20008081	Light grey	For BCD 200
BCD 250 WB-7035	20008082	Light grey	For BCD 250

Scope of delivery: 1 Wall-mounting fastening bracket, screws

Note: Special colours on request. Fitting to the enclosure rear is from the outside.



Wall fitting for flat bases (BCD...-0,5), swivelling

Model	Order no.	Note
BCD 160-0.5-7024 UWB	20816024	For BCD 160
BCD 200-0.5-7024 UWB	20820024	For BCD 200
BCD 250-0.5-7024 UWB	20825024	For BCD 250

Scope of delivery: Profile, 2 side flanges (complete), screws, covers

Note: Fixed positions in 10° detent stages. Mechanical processing of the enclosures is required.



Bocard accessories



Front panels, natural-coloured anodised aluminium

Model	Order no.	Note
BCD FP 160	20163000	For BCD 160
BCD FP 200	20203000	For BCD 200
BCD FP 250	20253000	For BCD 250

Scope of delivery: 1 front panel

Note: Front panels with a max. thickness of 3 mm can be fitted to the enclosures in this series. Please order fixing screws separately (order no. 59006233). Additional sizes on request.



Front panels for enclosures with terminal compartment, natural-coloured anodised aluminium

Model	Order no.	Note
BCD FP 160 K	20163100	For BCD 160
BCD FP 200 K	20203100	For BCD 200
BCD FP 250 K	20253100	For BCD 250

Scope of delivery: 1 front panel for enclosures with terminal compartment

Note: Front panels with a max. thickness of 3 mm can be fitted to the enclosures in this series. Please order fixing screws separately (order no. 59006233). Additional sizes on request.



Front panels for enclosures with 2 terminal compartments, natural-coloured anodised aluminium

Model	Order no.	Note
BCD FP 160 BK	20163200	For BCD 160
BCD FP 200 BK	20203200	For BCD 200
BCD FP 250 BK	20253200	For BCD 250

Scope of delivery: 1 front panel for enclosures with 2 terminal compartments

Note: Front panels with a max. thickness of 3 mm can be fitted to the enclosures in this series. Please order fixing screws separately (order no. 59006233). Additional sizes on request.



Front panels, ABS light grey, embossed on one side

Model	Order no.	Note
BCD FPK 160	20164000	For BCD 160
BCD FPK 200	20204000	For BCD 200
BCD FPK 250	20254000	For BCD 250

Scope of delivery: 1 front panel

Note: Front panels with a max. thickness of 3 mm can be fitted to the enclosures in this series. Please order fixing screws separately (order no. 59006233). Additional sizes on request.

Bocard accessories

Front panels for enclosures with terminal compartment, ABS light grey, embossed on one side

Model	Order no.	Note
BCD FPK 160 K	20164100	For BCD 160
BCD FPK 200 K	20204100	For BCD 200
BCD FPK 250 K	20254100	For BCD 250

Scope of delivery: 1 front panel for enclosures with terminal compartment

Note: Front panels with a max. thickness of 3 mm can be fitted to the enclosures in this series. Please order fixing screws separately (order no. 59006233). Additional sizes on request.



Front panels for enclosures with 2 terminal compartments, ABS light grey, embossed on one side

Model	Order no.	Note
BCD FPK 160 BK	20164200	For BCD 160
BCD FPK 200 BK	20204200	For BCD 200
BCD FPK 250 BK	20254200	For BCD 250

Scope of delivery: 1 front panel for enclosures with 2 terminal compartments

Note: Front panels with a max. thickness of 3 mm can be fitted to the enclosures in this series. Please order fixing screws separately (order no. 59006233). Additional sizes on request.



Mounting panels, laminated paper

Model	Order no.	Note
BCD M 160	20166000	For BCD 160
BCD M 200	20206000	For BCD 200
BCD M 250	20256000	For BCD 250

Scope of delivery: 1 mounting panel

Note: Please order fixing screws separately (order no. 59006233).



Panels for dividing terminal compartments, insertable, laminated paper

Model	Order no.	Note
BCD TP 160	20165000	For BCD 160 UT
BCD TP 160-0,5	20165100	For BCD 160 UT-0,5
BCD TP 200	20205000	For BCD 200 UT
BCD TP 200-0,5	20205100	For BCD 200 UT-0,5
BCD TP 250	20255000	For BCD 250 UT
BCD TP 250-0,5	20255100	For BCD 250 UT-0,5

Scope of delivery: 1 partition panel



Bocard accessories

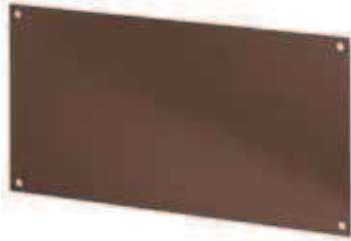

Partitions for dividing electronics compartments, screw-on, laminated paper

Model	Order no.	Note
BCD TP 160 F	20165200	For BCD 160
BCD TP 200 F	20205200	For BCD 200
BCD TP 250 F	20255200	For BCD 250

Scope of delivery: 1 partition panel

Note: Please order fixing screws separately (order no. 59006233). Additional sizes on request.



Cylinder lock for front lid BCD...OT-G and BCD...OT-FSC-...

Model	Order no.
SHLO 402	21008320

Scope of delivery: 1 lock, 2 keys

Note: The lock can be inserted into the opening in the BCD ... OT-G and BCD...OT-FSC-... at a later date. If a blind plug or catch has been fitted, it can be pushed out from the rear. The key can only be removed from the locked position.



DIN rail holder for rails DIN 60715 TH 35

Model	Order no.	Colour
TSH 35-2	20035000	Black

Scope of delivery: 2 DIN rail holders, screws

Note: Fixing domes for fitting of the TSH 35-2 are already moulded onto the Bocard bases up to size BCD 250. The ingress protection category for the Bocard enclosure is not affected.

Bocard accessories

DIN rails TS 15 / TS 35, top hat rail DIN EN 60715 TH 15 / TH 35

Model	Order no.	Note
TS 15.160.1	22151601	For BCD 160, terminal compartment, down
TS 15.185.1	22151851	For BCD 160, terminal compartment up
TS 35.160.1	22351601	For BCD 160, centre down
TS 15.215.1	22152151	For BCD 200, terminal compartment up
TS 35.198.1	22351981	For BCD 200, centre on distance bolt
TS 15.225.1	22152251	For BCD 250, terminal compartment down
TS 15.250.1	22152501	For BCD 250, terminal compartment up
TS 35.225.1	22352251	For BCD 250, terminal compartment, down / centre down
TS 35.233.1	22352331	For BCD 250, centre on distance bolt

Scope of delivery: 1 DIN rail

Note: Please order fixing screws separately (order no. 59006233). Additional sizes on request.



Fixing screws for DIN rails, front / mounting panels and partitions

Model	Order no.	Note
SHR Z KA 30 x 10	59006233	Galvanised steel

Scope of delivery: 1 screw

Distance bolts for mounting bosses, Ø 2.4-2.6 mm

Model	Order no.	Note
DIBLZ AK 30x5/IM3/10	59006986	ND = 2.4-2.6

Scope of delivery: 1 distance bolt

Note: The distance bolt can also be used to fix PCBs or mounting panels. This also makes it possible to fit (clearance 10 mm; M3) a parallel PCB or mounting panel. ND = boss internal diameter.



Seals for installation area

Model	Order no.	Note
BCD 160 CF-DI	20161400	For BCD 160 CF
BCD 200 CF-DI	20201400	For BCD 200 CF
BCD 250 CF-DI	20251400	For BCD 250 CF

Scope of delivery: 1 seal

Note: Alternatively the seal can be glued to the control panel (positioned over the internal cut-out) or to the installation area.

Ingress protection acc. to DIN EN 60529 possible up to max. IP 65, depending on thickness and type of control panel.