



PHOENIX MECANO

ANG Panel Meter Housings

Panel Mount Enclosure System



For Finishing Services, Product Support, or to Order

Call 1-301-696-9800



ANG Panel Meter Housing offers NEMA 4X protection. This ¼ DIN housing body is a hollow extrusion of heavy duty aluminum for maximum integrity with internal slotting to

ANG Panel Meter Housings

accommodate printed circuit boards or chassis. Gasketed, cast aluminum front and rear lids provide maximum protection. External mounting bars provide secure panel mounting in 2 or 4 positions.

ANG Panel Meter Housings offer easy maintenance benefits. The front bezel and rear lid can be taken off without removing the housing from the panel. These housings fit into pre-existing panels. Standard depths of 109.5mm and 165.5mm are available off-the-shelf in black. Custom lengths and colors are available

ANG Panel Meter Housing comes complete with, enclosure body, mounting profiles, bezel, front frame, rear lid, 1.5 allen key, adhesive plate, screws and washers.

TECHNICAL DATA:

- Color—Black Powdercoat
- Material—Extruded Aluminum
- Protection Classifications:
NEMA 4X
IP 66, DIN 40050Th

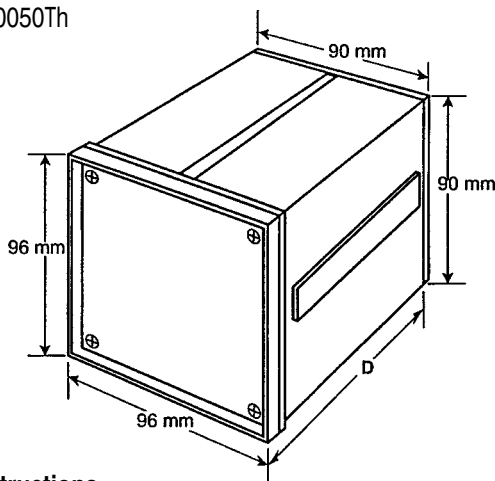

Assembly Instructions

Housings conform to DIN 43700. Install in a panel cut-out with dimensions of 92 x 92mm + .8mm. Remove mounting bars. Insert in panel cut-out. Install mounting bars. Tighten mounting bars with set screws to secure housing in panel.

ANG Panel Meter Housings					
Part #	Length	Width	Height	Weight	
ANG 9610	4.31/109.5	3.77/96	3.77/96	1.44 lbs.	
ANG 9616	6.51/165.5	3.77/96	3.77/96	1.64 lbs.	
ANG 9601	Sold in one meter lengths UNPAINTED.			8.0 lbs.	

Note: Dimensions are external. Metric is the primary dimension. Inch conversions are for the user's convenience and are for reference only.

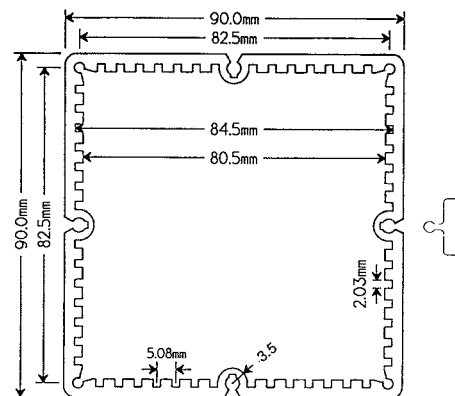

Enclosure Profile



ANG Housings

ANG 9610, ANG 9616, ANG 9601

External Dimensions: W 96 x H 96 mm

Page 3-21

Standard Features
<ul style="list-style-type: none"> • ANG 9610 Panel Meter Housing includes: enclosure body, mounting profiles, bezel, front frame, rear lid, 1.5 allen key, adhesive plate, screws and washers. L109.5 x W96 x H96 mm. • ANG 9616 Panel Meter Housing includes: enclosure body, mounting profiles, bezel, front frame, rear lid, 1.5 allen key, adhesive plate, screws and washers. L165.5 x W96 x H96 mm. • ANG 9601 Closed aluminum extrusion, sold in meter lengths UNPAINTED. L1000xW90xH90 mm.
Accessories
<ul style="list-style-type: none"> • ANG 96 MPI Aluminum Mounting Panel. • ANG 96 BZ Front Bezel • ANG 96 FF Front Open Frame • ANG 96 RL Rear Cover • SST 1230 NG Replacement Screws (set of 8).

Housing Profile and Mounting Bar Dimensions

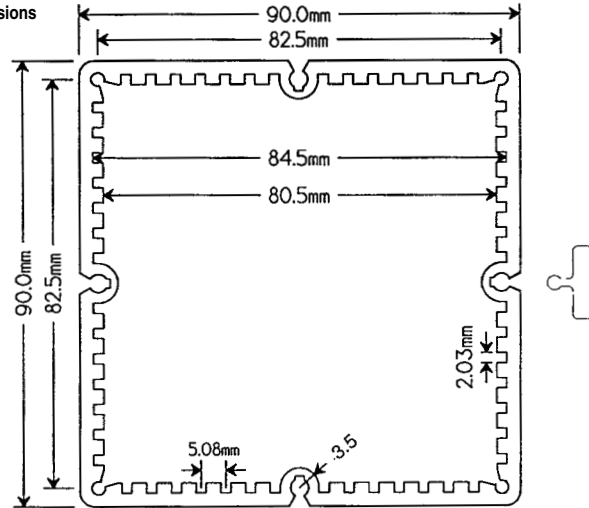

Front Bezel Dimensions/ANG 96 BZ

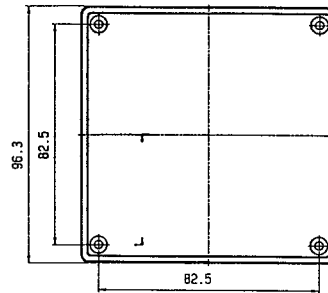
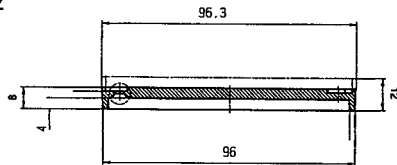

Front Open Frame Dimensions/ANG 96 FF

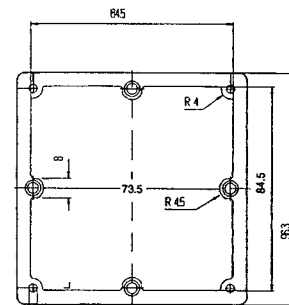
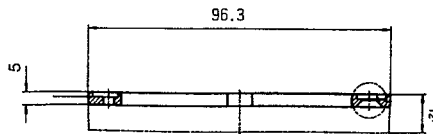

Rear Cover Dimensions/ANG 96 RL

