

DE2704300L

Silicon epitaxial planar type

For ESD protection

DE2S043 in SSSMini2 type package

■ Features

- High ESD
- Halogen-free / RoHS compliant
(EU RoHS / UL-94 V-0 / MSL:Level 1 compliant)

■ Marking Symbol:9C

■ Packaging

Embossed type (Thermo-compression sealing) 10 000 pcs / reel (standard)

■ Absolute Maximum Ratings Ta = 25 °C

Parameter	Symbol	Rating	Unit
Total power dissipation ^{*1}	PT	120	mW
Electrostatic discharge ^{*2}	ESD	±30	kV
Junction temperature	Tj	150	°C
Operating ambient temperature	Topr	-40 to +85	°C
Storage temperature	Tstg	-55 to +150	°C

Note) *1: Mounted on glass epoxy print board. (45 mm x 45 mm x 1 mm)

Solder in (0.4 mm x 0.3 mm)

*2: Test method:IEC61000_4_2(C = 150 pF,R = 330 Ω, Contact discharge:10 times)

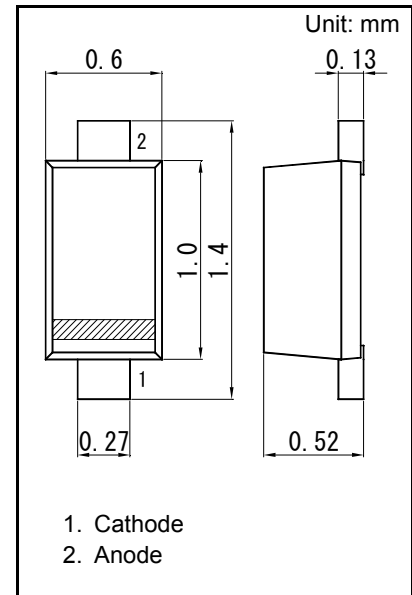

Panasonic	SSSMini2-F4-B
JEITA	SC-104A
Code	SOD-723

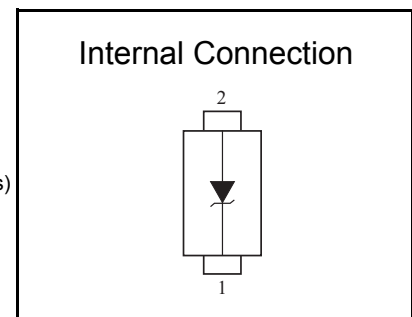

■ Electrical Characteristics Ta = 25 °C ± 3 °C

Parameter	Symbol	Conditions	Min	Typ	Max	Unit
Zener voltage ^{*1,*2}	VZ	IZ = 1 mA	4.09		4.52	V
Reverse current	IR	VR = 1 V			10.0	μA
Terminal capacitance	Ct	VR = 0V, f = 1 MHz		91		pF
Temperature coefficient of zener voltage ^{*3}	SZ	IZ = 1 mA		-2.1		mV/°C

Note) 1. Measuring methods are based on JAPANESE INDUSTRIAL STANDARD JIS C 7031 Measuring methods for Diodes.

2. *1: The temperature must be controlled 25°C for VZ measurement.

VZ value measured at other temperature must be adjusted to VZ (25°C)

*2: VZ guaranteed 20 ms after current flow.

*3: Tj = 25°C to 150°C