

# Gladius G1220

## 12.1" Intel® Atom™ N2600 Rugged Tablet PC



### Features

- 12.1" TFT active matrix with resistive touch
- Ultra low power consumption for 6-hour battery life
- Fully rugged for mobile POS or warehousing application
- Meeting MIL-STD-810F, IP54, 3ft. Drop Resistance
- High mobility with multiple connectivity (Bluetooth/WLAN)
- Hot-swappable redundant dual batteries

### System

CPU	Intel® Atom™ Processor N2600 dual-core 1.6GHz
Graphics Controller	Intel® GMA3600
Memory	2GB DDR3 SO-DIMM memory module installed
Chipset	Intel® NM10
BIOS	AMI Aptio® UEFI BIOS
Audio	1 x Integrated microphone
	2 x Integrated 2W speakers
	1 x Earphone jack
	1 x Microphone jack
Storage	1 x 32GB MLC SSD
	1 x 2.5" HDD/SSD Drive (optional)

### Peripherals and Devices

Camera	Optional 5.0 MPs rear-facing AF CMOS camera w/o LED
WLAN	Integrated WLAN 802.11 a/b/g/n
Bluetooth	Integrated Bluetooth 4.0 BLE, Class II

### I/O Interface

USB Port	4 x USB 2.0 ports
Serial Port	1 x 20-pin connector for two RS-232 ports
Ethernet	1 x RJ45 GbE LAN
Docking Port	1 x 35-pin pogo connector for docking connection
SD Card	1 x SDHC/SD card slot

### Button & Indicator

Function Key	4 x Function keys
Power Button	1 x Power on/off button
LED Indicator	2 x Battery LEDs
	1 x HDD/SSD Active LED
	1 x Power LED

### Touch Screen

Type	Analog resistive touch
Light Transparency	80%
Controller Interface	USB Interface

### LCD Display

Size/Type	12.1" TFT Active Matrix Panel
Max. Resolution	1024 x 768 (XGA) with 16.2M colors
Luminance	500 cd/m2 (typ.)
Contrast Ratio	700 :1
View Angle (U/D/R/L)	70°/70°/80°/80°
Backlight Type	LED

### Power Supply

Adapter Input	100 ~ 240VAC (Full Range)
Adapter Output	19VDC, 4.74A, 90W
Battery Type	Li-battery pack
Battery Capacity	2 x 1880mAh 4-cell external battery packs
Battery Operating Time	6 hours (typ.)

### Mechanical & Environmental

Operating Temp.	-20 ~ 40°C (-4 ~ 104°F)
Charging Temp.	0 ~ 40°C (32 ~ 104°F)
Storage Temp.	-20 ~ 60°C (-4 ~ 140°F)
Operating Humidity	10 ~ 95% @ 40°C (non-condensing)
Dimensions (W x D x H)	320 x 246 x 29.5 mm (12.60" x 9.69" x 1.16")
Gross Weight	1.9 Kg (4.19 lb)
Vibration	3 Grms/ 5 ~ 500Hz/ random operation
Shock	40G peak acceleration (11 ms duration)
Transit Drop	3 ft., except the front side
IP Rating	IP-54 (whole unit)
Regulatory	CE/FCC Class B, VCCI, PSE and TELEC certified

### OS Support

Windows Embedded 7 / Windows 7 Professional  
Ubuntu and Fedora Linux compatible

### Ordering Information

G1220	12.1" Intel® Cedar Trail N2600 Rugged Tablet PC with dual external battery packs, Bluetooth and WiFi
-------	------------------------------------------------------------------------------------------------------





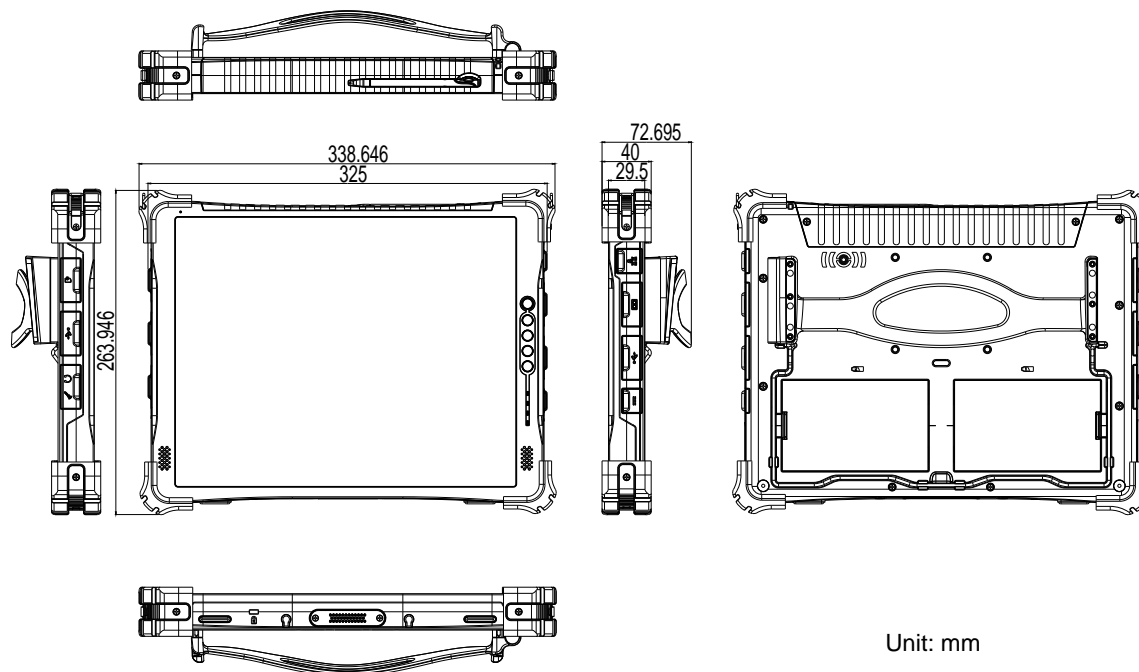

## Dimensions











Unit: mm



### Standard Accessories

PAC-G090W	20V/4.5A 90W AC/DC Adapter Kit	
BAT-G1220	2 x Gray 1880mAh External Battery Kit	
Stylus	Touch Screen Stylus (with rope)	
RS232 COM Cable	1-to-2 RS232 Cable	

### Optional Accessories

PAC-G090W	20V/4.5A 90W AC/DC Adapter Kit	
eBAT-1220	Battery Kit for G1220 (2 packs)	
Stylus	Touch Screen Stylus	
Stand-1220	Desktop Stand	
HST-1220	For one-handed hold of the computer	
SST-1220	Shoulder Strap, 128 x 3.7cm	
RS232 COM Cable	1-to-2 RS232 Cable	
DTC-1220	Desktop cradle for G1220 (See page 029)	

### Optional Configuration (CTOS\* Kit) (Not Sold Separately)

HDD320G-1220	320GB HDD Kit	
CAM-1220	5.0M Rear CMOS Camera Kit	

\*CTOS means Configure-to-Order Service.

All specifications are subject to change without notice.