

ARES-6663

Robust Fanless Box PC with Intel® Core™ i5-3610ME Platform



Features

- Fanless Design
- Rugged Design for Shock/Vibration Protection
- 6 x LAN and 6 x Serial Ports supported
- RS-485 Auto-flow supported
- Various Video Interfaces supported (Analog RGB, DVI-D)
- Optional Wi-Fi or HSUPA Wireless Connection supported
- Easy Installation/Maintenance
- Intel® SSD compatible

System	
CPU	Intel® Ivy Bridge rPGA988 (Socket G2) Intel® Core™ i5-3610ME 2.7GHz installed by default
Memory	1 x 204-pin DDR3 SO-DIMM socket, supporting 1333/1600MHz SDRAM up to 8GB
Chipset	Intel® QM77
Graphics	Integrated Intel® HD4000
ATA	2 x Serial ATA ports with 600MB/s HDD transfer rate
LAN Chipset	6 x Realtek 8111 GbE controllers
Watchdog Timer	1~255 levels reset
I/O	
Serial Port	COM1 and COM2 are RS-232 ports via two DB-9 male connectors. COM3 to COM6 are RS-232/422/485 configurable via one 2x10-pin terminal block.
USB Port	4 x USB 2.0 ports 2 x USB 3.0/2.0 ports
LAN	6 x RJ-45 ports for GbE
Video Port	1 x DB-15 female connector for Analog RGB 1 x DVI-D female connector for digital video output
Digital I/O	1 x 16-bit digital input/output, 8-in/8-out
Audio	Mic-in/Line-out
Expansion Bus	1 x PCI slot & 1 x PCIe x4 slot (EP) or 2 x PCI slots (2P) 1 x Mini-card socket interconnected with SIM card socket for optional Wi-Fi or HSUPA module 1 x SIM socket 1 x PCI/104
Environmental	
Operating Temp.	-10 ~ 60°C (14 ~ 140°F), ambient w/ air flow
Storage Temp.	-20 ~ 80°C (-4 ~ 176°F)
Operating Humidity	10 ~ 95% @ 60°C (non-condensing)
Vibration	3G rms/5~500Hz /random Operation
Shock	Operating 40G (11 ms) Non-operation 60G with SSD

Qualification	
Certification	CE, FCC Class A
Power Requirement	
Power Input	DC 9~36V input (w/ 4-pin DC input terminal block, combining remote power on/off switch)
Power Consumption	Max. 67W (i5 w/o I/O card)
Storage	
Type	2 x 2.5" drive bays for HDD/SSD 1 x SATA port for SATA DOM 1 x CFAST socket 1 x 8GB NAND Flash (optional)
Mechanical	
Construction	Aluminum alloy
Mounting	Wall-mount
Weight	4 kg (8.8 lb)
Dimensions (W x D x H)	254 x 187 x 100 mm (10" x 7.36" x 3.93")
OS Support	
XPe / XP Pro / W7 Pro / WS7E	
Ordering Information	
ARES-6663-EP/3610ME	Barebone system w/ Intel® i5-3610ME, 6 x LAN, PCI + PCIe x4
ARES-6663-2P/3610ME	Barebone system w/ Intel® i5-3610ME, 6 x LAN, 2 x PCI





» Fanless Design



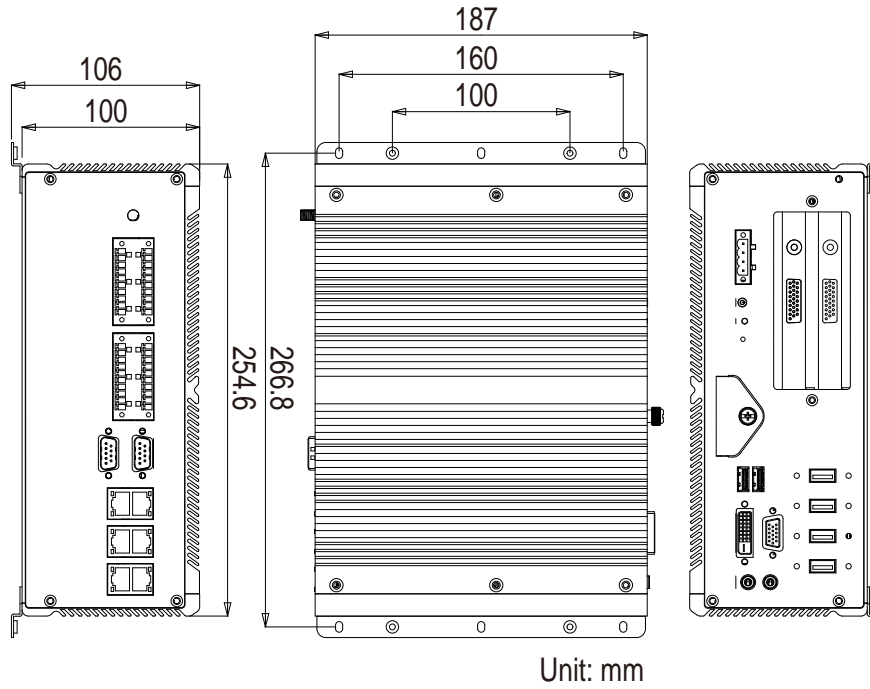



Dimensions



Optional Accessories

PAC-B120W-FSP	19V/6.32A 120W AC/DC adapter kit	
WMK-5000	Wall-mount kit for FPC-5XXX Series	

Optional Configuration (CTOS* Kit)

SSD-25032	Memoright 2.5" 32GB SATAII SSD kit	
HSPA-SI1400	HSUPA 3.75G module kit & internal wiring	
WIFI-AT2300	Atheros AR9462 Wi-Fi module w/ 20cm internal wiring	
ANT-D11	1 x Wi-Fi dual-band 2.4G/5G antenna	
ANT-H11	1 x 2dBi HSUPA antenna	
MM-3C-2G	DDR3-1333 2GB SDRAM	
MM-3C-4G	DDR3-1333 4GB SDRAM	
MM-3C-8G	DDR3-1600 8GB SDRAM	

*CTOS means Configure-to-Order Service.

