

FPC-7703/7702/7701

Robust Box PC with 3rd Generation Intel® Core™ i7/i5/i3/Celeron® Processor Platform



Features

- Fanless Design
- Wide Range DC Power Input (9 ~36V)
- iAMT supported
- Various Video Interfaces (DVI-I + DVI-D) supported
- Optional Wi-Fi or HSUPA Wireless Connectivity supported
- Rugged Design for Shock/Vibration Protection
- Memory support up to 16GB (DDR3)
- RAID 0,1 supported
- Intel® SSD compatible

System	
CPU	3 rd Generation Intel® Core™ i7/i5/i3 or Celeron® processors in rPGA988 socket
Memory	2 x 204-pin DDR3 SO-DIMM sockets, supporting 1333/1600MHz SDRAM up to 16GB
Chipset	Intel® QM77
Graphics	Integrated Intel® HD 4000
ATA	2 x Serial ATA ports with 600MB/s HDD transfer rate 2 x eSATA
LAN Chipset	2 x Intel® WG82583V GbE controllers 1 x Intel® WG82579LM GbE PHY w/ iAMT
Watchdog Timer	1~255 levels reset
I/O	
Serial Port	4 x RS-232 ports via one DB-44 female connector. (COM3 and COM4 are RS-232/422/485 configurable, w/ isolated protection.)
USB Port	6 x USB 2.0 ports, 4 x USB 3.0/ 2.0 ports 2 x internal USB dongle for software license key (optional)
LAN	3 x RJ-45 ports for GbE
Video Port	1 x DVI-I female connector for Digital/ analog video output 1 x DVI-D female connector for digital video output
Selectable Port	1 x DB25 connector for 1 x DIO (8 in/8 out) port or 1 x LPT port (either one) DIO by default, can be changed to LPT
Audio	Mic-in/Line-out
Expansion Bus	1 x Mini-card socket interconnected with SIM card socket for optional Wi-Fi or HSUPA module 1 x SIM socket/1 x CFast socket (outside accessible) 1 x PCIe x16 slot + 1 x PCI slot (FPC-7701) 1 x PCIe x16 slot + 1 x PCIe x8 slot (via x4 lanes) (FPC-7702) 2 x PCI (FPC-7703)

Environmental

Operating Temp.	-20 ~ 55°C (-4 ~ 131°F), ambient w/ air flow
Storage Temp.	-40 ~ 85°C (-40 ~ 185°F)
Operating Humidity	10 ~ 95% @ 55°C (non-condensing)
Vibration	3 Grms/5~500Hz/random operation w/ SSD
Shock	Operating 40G (11ms), Non-operating 60G with SSD

Qualification

Certification	CE, FCC Class A
---------------	-----------------

Power Requirement

Power Input	DC 9~36V input w/ 4-pin terminal block
Power Consumption	Max. 75W (w/o I/O card)

Storage

Type	2 x 2.5" drive bays 1 x CFast socket, can be outside accessible
------	--

Mechanical

Construction	Aluminum alloy
Mounting	Wall-mount
Weight	7 kg (15.43 lb)
Dimensions (W x D x H)	225 x 267 x 120 mm

OS Support

XP Pro / W7 Pro / WS7E

Ordering Information

FPC-7703	Fanless system w/ 2 x PCI
FPC-7702	Fanless system w/ 1 x PCIe x8 + 1 x PCIe x16
FPC-7701	Fanless system w/ 1 x PCI + 1 x PCIe x16

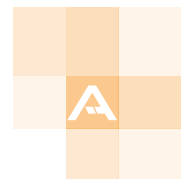

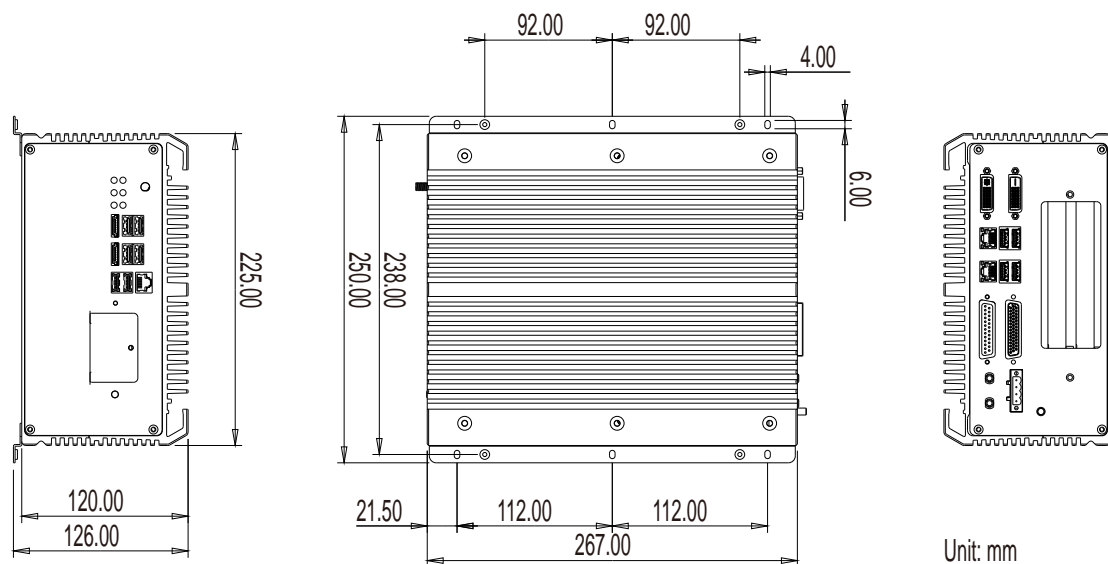

Dimensions











Unit: mm

Optional Accessories

PAC-B120W-FSP	19V/6.32A 120W AC/DC adapter kit	
CBL-7100-COM	4 x COM ports converter cable	
WMK-7000	Wall-mount kit for FPC-7XXX Series	

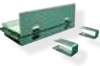
Optional Configuration (CTOS* Kit)

80GB SSD	Intel® 2.5" 80GB SATAIII SSD kit	
HSPA-SI1400	HSUPA 3.75G module kit & internal wiring	
WIFI-AT2300	Atheros AR9462 Wi-Fi Module w/ 20cm internal wiring	
ANT-H11	1 x 2dBi HSUPA antenna	
ANT-D11	1 x Wi-Fi dual-band 2.4G/5G antenna	
Core™ i3-3120ME	3 rd Generation Intel® Core™ i3-3120ME , L2/3M, 2.4G	
Core™ i5-3610ME	3 rd Generation Intel® Core™ i5-3610ME, L2/3M, 2.7G	
Core™ i7-3610QE	3 rd Generation Intel® Core™ i7-3610QE, L2/6M, 2.3G	
MK-3C-4G-1	DDR3-1333 4GB SDRAM DIMM1 kit	
MK-3C-4G-2	DDR3-1333 4GB SDRAM DIMM2 kit	
MK-3C-8G-1	DDR3-1600 8GB SDRAM DIMM1 kit	
MK-3C-8G-2	DDR3-1600 8GB SDRAM DIMM2 kit	
UDK-7702	Internal USB dongle kit for FPC-7701/7702/7703	

*CTOS means Configure-to-Order Service.