

# Amphenol

## C 16-1 / C 16-3

---



Circular  
Circular Connectors

Amphenol-Tuchel Electronics

---

**General information**



We reserve the right to change the design due to improvement in quality, development or production requirements.

With this release all former releases are no longer valid.

This catalogue must not be used in any form or manner without our prior approval in writing (Copyright Law, Fair Trading Law, Civil Code).

# Content

# Page

**General information**

**2**

**Technical information**

**4**

**Remarks/Safety classification**

**7**

**Series C 16-1**



**View**

**8**

Product description

**9**

Order information

Approvals

Characteristics

**10**

Derating curves

**11**

Mounting instructions

Male cable connectors

**12**

Female receptacles

**13**

Female cable connectors

**14**

Male receptacles

**15**

Accessories

**16**

**View**

**17**

Product description

**18**

Order information

Approvals

Coding system

**19**

Characteristics

**20**

Derating curves

**21**

View of connector style

**22**

Mounting instruction

**23**

**Shell size 1**

Male cable connectors

**24**

Female receptacles

**25**

Female cable connectors

Male receptacles

**26**

Accessories

**Shell size 2**

Male cable connectors

**27**

Female receptacles

Female cable connectors

**28**

Male receptacles

Accessories

**29**

**Crimp contacts pin**

**30**

**Crimp contacts socket**

**31**

**Part No. system for crimp contacts**

**32**

**Summary of Part Numbers**

**33**

**Termination methods**

• **Screw connection**

Screw clamps are designed acc. to EN 60999/VDE 0609. Chart 1 below shows the screw size depending on wire size and the required clamping and testing torque.

**Chart 1**

Wire size (mm <sup>2</sup> )	1	1,5	2,5	4	6	10
Screw size	M 2,6	M 3	M 3	M 3,5	M 4	M 4
Test torque (Ncm)	40	50	50	80	120	120

Diagram 1 below shows the range of tensile strength for a screw connection with a clamp screw M3, fastened with a torque of 50 Ncm, depending on the wire size.

**Diagram 1**

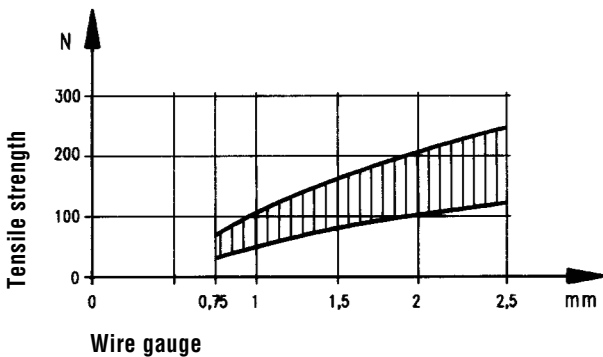

This comparison chart allows a cross reference between American Wire Gauge (AWG) and metric wire sizes (mm<sup>2</sup>).

**Chart 2**

AWG	Wire composition	Wire diameter	Wire size
30	1 x 0,25 7 x 0,10	0,25 mm 0,36 mm	0,05 mm <sup>2</sup> 0,06 mm <sup>2</sup>
28	1 x 0,32 7 x 0,13	0,32 mm 0,38 mm	0,08 mm <sup>2</sup> 0,09 mm <sup>2</sup>
26	1 x 0,40 7 x 0,16 19 x 0,10	0,40 mm 0,48 mm 0,51 mm	0,13 mm <sup>2</sup> 0,14 mm <sup>2</sup> 0,15 mm <sup>2</sup>
24	1 x 0,51 7 x 0,20 19 x 0,13	0,51 mm 0,61 mm 0,64 mm	0,21 mm <sup>2</sup> 0,23 mm <sup>2</sup> 0,24 mm <sup>2</sup>
22	1 x 0,64 7 x 0,25 19 x 0,16	0,64 mm 0,76 mm 0,81 mm	0,33 mm <sup>2</sup> 0,36 mm <sup>2</sup> 0,38 mm <sup>2</sup>
20	1 x 0,81 7 x 0,32 19 x 0,20	0,81 mm 0,97 mm 1,02 mm	0,52 mm <sup>2</sup> 0,56 mm <sup>2</sup> 0,62 mm <sup>2</sup>
18	1 x 1,02 19 x 0,25	1,02 mm 1,27 mm	0,79 mm <sup>2</sup> 0,96 mm <sup>2</sup>
16	19 x 0,29	1,44 mm	1,23 mm <sup>2</sup>
14	19 x 0,36	1,80 mm	1,95 mm <sup>2</sup>
12	19 x 0,46	2,29 mm	3,09 mm <sup>2</sup>
10	37 x 0,40	3,10 mm	4,60 mm <sup>2</sup>
8	133 x 0,29	4,0 mm	8,80 mm <sup>2</sup>
6	133 x 0,36	5,5 mm	13,5 mm <sup>2</sup>

It has to be noted that wires of the same AWG number but with different composition have slightly different mm<sup>2</sup>.

**Chart 3**

Composition and Dimensions of Copper Wires

Wire Size	Wire Composition	Wire diameter
0,09 mm <sup>2</sup>	12 x 0,10	0,48 mm
0,14 mm <sup>2</sup>	18 x 0,10	0,50 mm
0,25 mm <sup>2</sup>	14 x 0,15	0,70 mm
0,34 mm <sup>2</sup>	7 x 0,25	0,78 mm
0,5 mm <sup>2</sup>	16 x 0,20	1,0 mm
0,75 mm <sup>2</sup>	24 x 0,20	1,2 mm
1,0 mm <sup>2</sup>	32 x 0,20	1,4 mm
1,5 mm <sup>2</sup>	30 x 0,25	1,6 mm
2,5 mm <sup>2</sup>	35 x 0,30	2,2 mm
4,0 mm <sup>2</sup>	56 x 0,30	2,8 mm
6,0 mm <sup>2</sup>	19 x 0,64	3,4 mm
10 mm <sup>2</sup>	19 x 0,80	4,3 mm

**• Crimp connection**

A crimp connection is a non-detachable electrical connection between a wire and a crimp contact produced with the crimp technology. Precise crimping dies which are matched to the crimp barrel and the wire size and a defined deformation result in a reliable electrical connection. There are open crimp barrels (stamped contacts) and closed crimp barrels (turned contacts).

The main advantages of crimp connections are:

- Efficient termination of contacts.
- Reproducible electrical and mechanical figures with a constant crimp quality.

The requirements for crimp connections are defined in DIN IEC 60352 Part 2.

An important point of the quality of a crimp connection is the achieved tensile strength of the termination.

Easily measured, the tensile strength is a practicable means for quality control purposes.

Diagram 2 below shows the required minimum tensile strength for open and closed barrels depending on the wire size.

**Assembly instructions**

For crimp contacts use the released crimp tool.

The insertion and extraction of crimp contacts shall only be approved with the corresponding insertion/extraction tool.

**A detailed description of the crimp technology can be found in our crimp tooling catalogs.**

Diagram 2

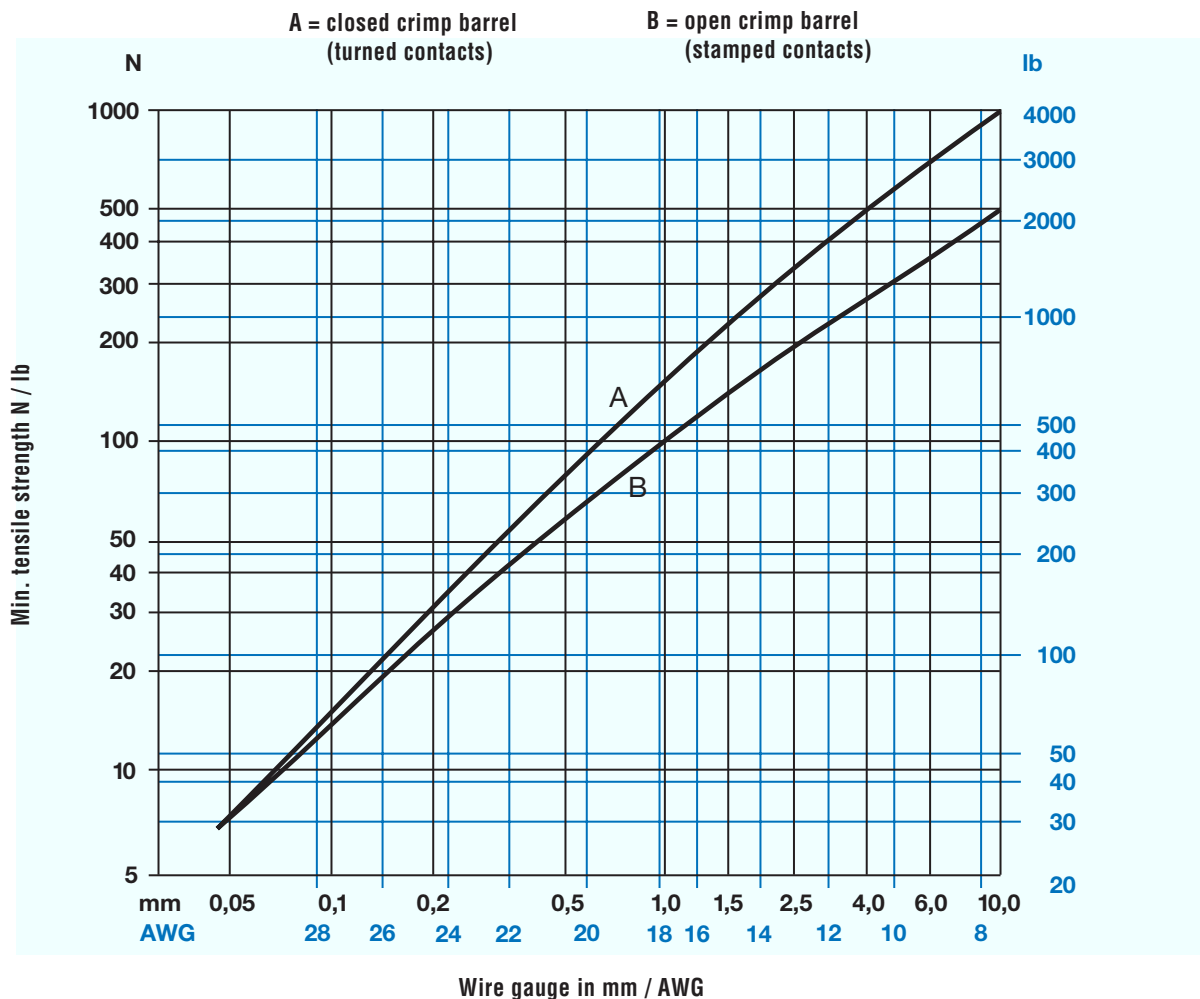

**Degree of protection**

Electrical devices to which connectors belong to have to be protected for safety reasons from outside influences like dust, foreign objects, direct contact, moisture and water. This protection is provided on industrial connectors by its housings with their latching devices and sealed cable entries. The degree of protection can be selected depending on the type of intended use. The standard IEC 60529 and/or DIN EN 60529 has specified the degree of protection and divided into several classes.

The degree of protection is indicated in the following way:

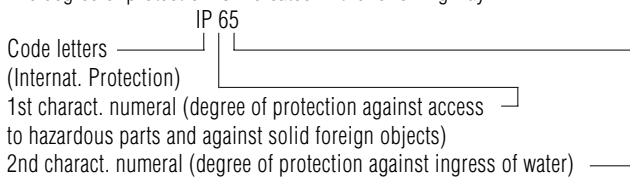

The following charts 11 an12 give an overview about all protection degrees.

**Chart 4**

1st charact. numeral	Brief description	Definition
0	Non-protected	–
1	Protected against access to hazardous parts with the back of a hand. Protected against solid foreign objects of $\geq 50\text{mm } \varnothing$ .	The probe, sphere of $50\text{mm } \varnothing$ , shall not fully penetrate and shall have adequate clearance from hazardous parts.
2	Protected against access to hazardous parts with a finger. Protected against solid foreign objects of $\geq 12,5\text{mm } \varnothing$ .	The jointed test finger of $12\text{mm } \varnothing$ , $80\text{mm}$ length, shall have adequate clearance from hazardous parts. The probe, sphere of $12,5\text{mm } \varnothing$ , shall not fully penetrate.
3	Protected against access to hazardous parts with a tool. Protected against solid foreign objects of $\geq 2,5\text{mm } \varnothing$ .	The probe of $2,5\text{mm } \varnothing$ shall not penetrate at all.
4	Protected against access to hazardous parts with a wire. Protected against solid foreign objects of $\geq 1\text{mm } \varnothing$ .	The probe of $1\text{mm } \varnothing$ shall not penetrate at all.
5	Protected against access to hazardous parts with a wire. Dust-protected.	The probe of $1\text{mm } \varnothing$ shall not penetrate. Intrusion of dust is not totally prevented, but dust shall not penetrate in a quantity to interfere with satisfactory operation of the device or to impair safety.
6	Protected against access to hazardous parts with a wire. Dust-tight.	The probe of $1\text{mm } \varnothing$ shall not penetrate. No intrusion of dust.

**Chart 5**

2nd charact. numeral	Brief description	Definition
0	Non-protected	–
1	Protected against vertically falling water drops	Vertically falling drops shall have no harmful effects.
2	Protected against vertically falling water drops when enclosure tilted up to $15^\circ$	Vertically falling drops shall have no harmful effects when the enclosure is tilted at any angle up to $15^\circ$ on either side of the vertical.
3	Protected against spraying water	Water sprayed at an angle up to $60^\circ$ on either side of the vertical shall have no harmful effects.
4	Protected against splashing water	Water splashed against the enclosure from any direction shall have no harmful effects.
5	Protected against water jets	Water projected in jets against the enclosure from any direction shall have no harmful effects.
6	Protected against powerful water jets	Water projected in powerful jets against the enclosure from any direction shall have no harmful effects.
7	Protected against the effects of temporary immersion in water	Intrusion of water in quantities causing harmful effects shall not be possible when the enclosure is temporarily immersed in water for 30 min. in $1\text{m}$ depth.
8	Protected against the effects of continuous immersion in water	Intrusion of water in quantities causing harmful effects shall not be possible when the enclosure is continuously immersed in water under conditions which shall be agreed between manufacturer and user but which are more severe than for numeral 7.
9 K <sup>1)</sup>	Protected against water during high pressure/steam jet cleaning	Water projected in powerful jets with high pressure against the enclosure from any direction shall have no harmful effects.

1) Remark: Numeral acc. to DIN 40050 part 9, vehicles IP code

# C 16-1/16-3

Remarks  
Safety classification



### 1. General Remarks

These connectors are designed and produced in conformity with the low voltage directive (72/23/EWG) respectively Gerätesicherheitsgesetz and according DIN VDE 57627 (German Law). All technical data refers to mated connectors under live conditions. The safety of the connector system depends on the correct selection of products, proper assembly of the connector device, and a precise fit of the connectors.

If in special cases connectors can be used in the sense of plug and socket devices, this is mentioned in the particular section.

### 2. Application Remarks

Connectors and/or plug and socket devices must be used according to specified technical ratings.

The technical data represents the initial value of mated parts under predetermined conditions and length of time. These values could change with different test parameters or product requirements.

The C 16-1/16-3 Series connectors are used in a wide variety of industries and equipment. Some of these include industrial machines and controls, data processing, instrumentation and test equipment, medical devices, telecommunication's network and equipment, plus outdoor and marine applications.

All rated data for the connectors listed in this catalog are based on over-voltage category III <sup>1)</sup> and pollution degree 3 <sup>2)</sup> for electronic applications. Connectors were completely mated according to their respective safety locking mechanism. Selection and testing of connectors and/or plug and socket devices to meet specific product or industrial requirements such as rated voltage and the related clearances and creepage distances are the responsibility of the user.

### 3. Assembling Remarks

Protection against electrical shock of the termination of the connectors shall be secured by correct mounting. Connectors of the same or different series being mounted side by side may be protected against incorrect mating by the use of coding options. Care must be taken to ensure the parts are correctly mated and screws are tightened with the proper torque.

### 4. Termination Remarks

Cable connectors are effectively secured when using the internal cable clamp. When the connector contains a simple gland bushing for retention the cable should have a strain relief close behind the connector. All cable properties or specifications must be compatible with the connector design and materials.

Designated wire conductors must be terminated to the correct poles in the connector.

Crimp contacts must be fully inserted into the plastic housing and retention assured with a slight tug on the wire.

Wire should be stripped correctly according to printed specifications to insure no electrical contact can be made between the conductors. There should be no nicked or cut strains during the stripping action.

### 5. Safety Classification acc. to DIN VDE 0627



Style	Safety classification <sup>3)</sup>			Connectors		Protective earth contact		Protection against electric shock		Cable clamp	
	A	B	C	free	fixed	with	without	mated	unmated	with	without
Male cable connector	X	X	X	X		X		X		X	X
Female cable connector	X	X	X	X		X		X	X	X	X
Male receptacle	X	X			X	X		X			X
Female receptacle	X	X			X	X		X	X		X

<sup>1)</sup> Overvoltage category III: Equipment intended for the use in installations or parts of it in which lightning overvoltages do not need to be considered, however switching overvoltages generated by the equipment, and for cases where the reliability and the availability of the equipment or its dependent circuits are subject to special requirements. Examples are protecting means, switches and sockets.

<sup>2)</sup> Pollution degree 3: Conductive pollution occurs or dry non-conductive pollution occurs which becomes conductive due to condensation which is to be expected.

<sup>3)</sup> A Connections to and from a device equipment    B Connections within a device equipment    C Free cable connections

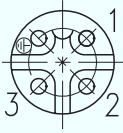





Overview			
No. of contacts	3 + PE	6 + PE	
Termination	screw	solder	crimp
Wire gauge	max. 2,5 mm <sup>2</sup> ; AWG 14	max. 0,75 mm <sup>2</sup> ; AWG 18	max. 1,5 mm <sup>2</sup> ; AWG 16
Rated insulation voltage	400 V	250 V	200 V
Current carrying capacity	16 A	10 A	13 A
Pollution degree	3	3	
Installation category	III	III	
Protection class	IP 67	IP 67	



# C 16-1

Product description  
Order information  
Approvals

Product description		Order information	
<p>The circular connectors of the C 16-1 series are designed to meet the high requirements of industrial applications under harsh environmental conditions. The range includes versions with screw, solder and crimp terminations. A selection of crimp contacts for hand crimp tools and crimp machines ensure a reliable termination resulting in qualitative, technical and economical advantages. A large selection of housing styles offers the user an optimal solution.</p> <p><b>Main features and advantages:</b></p> <ul style="list-style-type: none"> <li>• Circular connectors with contact arrangements 3 + PE and 6 + PE for power and signal applications</li> <li>• For applications in machine tools, measurement and control, process technology and medical equipment</li> <li>• Housing are made from high grade plastic material</li> <li>• Protected against unlocking by threaded coupling</li> <li>• Cable housing straight with PG 9, 11 and 13,5 cable outlet, Cable housing 90° with PG 9 and 11 cable outlet</li> <li>• Protection degree IP 67 per IEC 60529 in mated condition</li> <li>• Internal strain relief with screw clamp or clamping ring provides a safe cable restraint</li> </ul>		<p><b>Contact plating</b> The standard plating is silver. Gold plated contacts are available upon request. Min order quantity = 100 contacts per type.</p> <p><b>Color coding</b> Upon request the coupling ring of the plugs and the housings of the receptacles can be delivered in the colors red, green, blue, yellow and grey. Min order quantity = 250 pcs. per type.</p> <p><b>Mechanical coding</b> Achieved with special coding pins which are inserted into contact cavities. Min. order quantity = 250 pcs. per type.</p> <p><b>Crimp version</b> Order numbers do not include crimp contacts. Please order separately (see page 30/31). Crimp contact for higher currents (up to 16A) are available upon request.</p> <p><b>Crimp tooling</b> Ask for our catalog "Tools"</p>	
Testhouse		Characteristics	Approval No.
VDE		3+PE, 400 V, 16 A 6+PE, 250 V, 10 A	1781 1780
SEV		3+PE, 400 V, 16 A 6+PE, 250 V, 6 A	94.1 01173.02
UL		3+PE, 250 V, 12 A 6+PE, 250 V, 8 A	E 63093
CSA		3+PE, 250 V, 12 A 6+PE, 250 V, 8 A 6+PE, 250 V, 15 A	48932
German Llyod		3+PE, 250 V, 16 A 6+PE, 50 V, 8 A	14108 / 84

**C 16-1****Characteristics**

General Characteristics	Standard	Characteristics		
Number of contacts		3 + PE	6 + PE	
<b>Electrical Characteristics</b>		screw type	solder type	crimp type
Rated insulation voltage	IEC 60664-1	400 V	250 V	200 V
Rated impulse withstand voltage	IEC 60664-1	6000 V	4000 V	
Pollution degree	IEC 60664-1	3	3	
Installation (overvoltage) category	IEC 60664-1	III	III	
Material group	IEC 60664-1	II	II	
Test voltage	IEC 60664-1	2450 V	1680 V	1950 V
Current carrying capacity	IEC 60512-3, Test 5b	16 A / + 55 °C	10 A / + 55 °C	13 A / + 55 °C
Insulation resistance	IEC 60512-2, Test 3a	≥ 10 <sup>8</sup> Ω	≥ 10 <sup>8</sup> Ω	
Contact resistance	IEC 60512-2, Test 2a	≤ 5 m Ω	≤ 5 m Ω	
<b>Climatical Characteristics</b>				
Climatic category	IEC 6068-1	40 / 100 / 56	40 / 125 / 56	
Operating temperature		-40°C ... +100°C / -40°F ... +212°F		
<b>Mechanical Characteristics</b>				
IP-degree of protection	IEC 60529	IP 67		
Insertion and withdrawal force	IEC 60512-7, Test 13b	≤ 15 N	≤ 30 N	
Mechanical operation	IEC 60512-5, Test 9a	≥ 500 mating cycles		
<b>Materials</b>				
Housing material		Polyamid 6.6		
Dielectric material		Polyamid 6.6		
Gasket material		Neoprene		
Contact plating		silver plated (gold plated upon request)		
<b>Other Characteristics</b>				
Termination technique		screw type	solder	crimp
Wire gauge mm <sup>2</sup> / AWG		max. 2,5 / 14	0,75 / 18	0,14 - 1,5 / 26 - 16
Flammability		UL 94 V0		
Locking system		round thread DIN 405		



The stated technical values refer to the use as connector.

If these components are used as plug and socket device a reduced current carrying capacity has to be considered.

# C 16-1

## Derating curves

### No of contacts 3 + PE

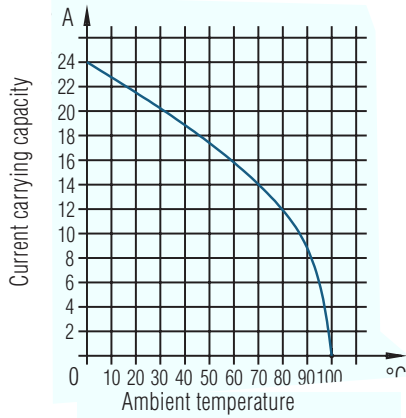

all contacts  
wire gauge 2,5 mm<sup>2</sup>, 14 AWG

### No of contacts 6 + PE

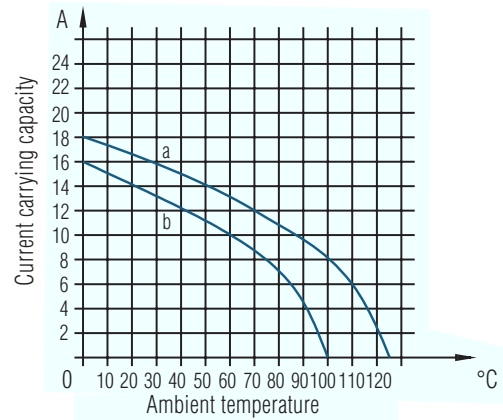

all contacts

- a) wire gauge 1,5 mm<sup>2</sup>, 16 AWG
- b) wire gauge 0,75 mm<sup>2</sup>, 20 AWG

# C 16-1

## Mounting instructions

Torque  
min. 1Nm  
max. 2Nm

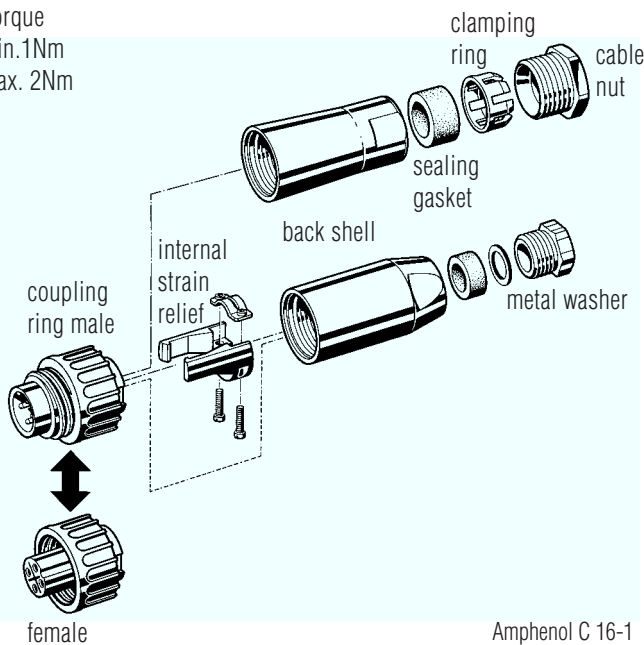

Torque  
min. 1Nm  
max. 2Nm

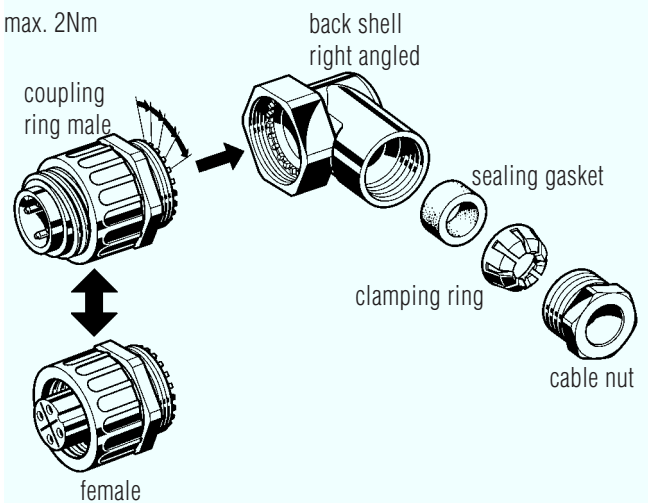

# C 16-1

## Male cable connectors



Description	Drawing	No. of cont.	Part. no. Cable outlet <sup>2)</sup>		
			PG 9	PG 11	PG 13,5
Male cable connector, 3+PE screw, 6+PE solder termination, with strain relief, VDE test certificate of conformity		3 + PE	T 3108 001	T 3108 101	T 3108 200 (with clamping ring)
		6 + PE	T 3104 001	T 3104 101	T 3104 200 (with clamping ring)
Male cable connector, 3+PE screw, 6+PE solder termination, without strain relief		3 + PE	T 3108 000	T 3108 100	–
		6 + PE	T 3104 000	T 3104 100	–
Male cable connector, crimp version without contacts <sup>1)</sup> , with strain relief, VDE test certificate of conformity		6 + PE	T 3104 501	T 3104 601	T 3104 701 (with clamping ring)
Male cable connector, right-angled, 3+PE screw, 6+PE solder termination, with clamping ring, VDE test certificate of conformity		3 + PE	T 3108 081	T 3108 091	–
		6 + PE	T 3104 081	T 3104 091	–
Male cable connector, right-angled, crimp version, without contacts <sup>1)</sup> , with clamping ring, VDE test certificate with supervision of production		6 + PE	T 3104 581	T 3104 591	–

<sup>1)</sup> Please order crimp contacts separately, see page 30/31.

<sup>2)</sup> Cable outlet in mm, see page 32.

# C 16-1

## Female receptacles

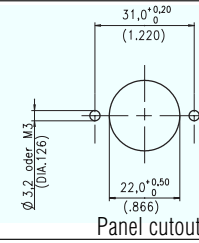

Panel cutout

Description	Drawing	No. of cont.	Part. no.
Female receptacle, screw termination, VDE test certificate of conformity		3 + PE	T 3111 000
Female receptacle, solder termination, VDE test certificate of conformity		6 + PE	T 3107 000
Female receptacle, crimp version, without contacts <sup>1)</sup> , VDE test certificate of conformity		6 + PE	T 3107 500

<sup>1)</sup> Please order crimp contacts separately, see page 30/31.

# C 16-1

## Female cable connectors



Description	Drawing	No. of cont.	Part No. Cable outlet <sup>2)</sup>		
			PG 9	PG 11	PG 13,5
Female cable connector, 3+PE screw, 6+PE solder termination, with strain relief, VDE test certificate of conformity		3 + PE	T 3109 001	T 3109 101	T 3109 200 (with clamping ring)
		6 + PE	T 3105 001	T 3105 101	T 3105 200
Female cable connector, 3+PE screw, 6+PE solder termination, without strain relief		3 + PE	T 3109 000	T 3109 100	T 3109 200
		6 + PE	T 3105 000	T 3105 100	T 3105 200
Female cable connector, crimp version without contacts <sup>1)</sup> , with strain relief, VDE test certificate of conformity		6 + PE	T 3105 501	T 3105 601	T 3105 701 (with clamping ring)
Female cable connector, right-angled, 3+PE screw, 6+PE solder termination, with clamping ring, VDE test certificate of conformity		3 + PE	T 3109 081	T 3109 091	–
		6 + PE	T 3105 081	T 3105 091	–
Female cable connector, right-angled, crimp version, without contacts <sup>1)</sup> , with clamping ring, VDE test certificate with supervision of production		6 + PE	T 3105 581	T 3105 591	–

<sup>1)</sup> Please order crimp contacts separately, see page 30/31.

<sup>2)</sup> Cable outlet in mm, see page 32.

# C 16-1

## Male receptacles

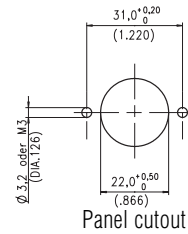





Description	Drawing	No. of cont.	Part No. Cable outlet
Male receptacle, screw termination, VDE test certificate of conformity		3 + PE	T 3110 000
Male receptacle, solder termination, VDE test certificate of conformity		6 + PE	T 3106 000
Male receptacle, crimp version, without contacts <sup>1)</sup> , VDE test certificate of conformity		6 + PE	T 3106 500
Male receptacle, straight dip solder pins		3 + PE	<p>Hole pattern on PCB</p>
		6 + PE	<p>Hole pattern on PCB</p>

<sup>1)</sup> Please order crimp contacts separately, see page 30/31.

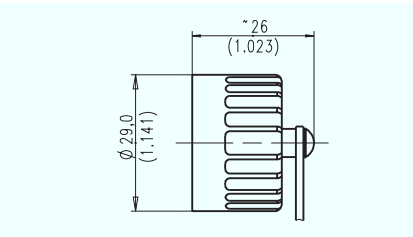
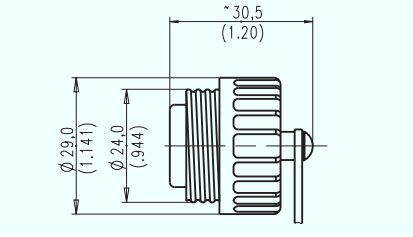
# C 16-1

## Accessories

Description	Figure	Part No.	
Protective cap for male cable connector and male receptacle		for male connector  T 6482 001	for male receptacle  T 6482 000
Protective cap for female cable connector and female receptacle		for female cable connector  T 6483 001	for female receptacle  T 6483 000
Backshell, straight version, packaging unit 10 pcs.		max. cable diameter <sup>1)</sup> PG 9  T 3102 003 7 X	max. cable diameter <sup>1)</sup> PG 11  T 3102 004 7 X
Back shell, straight version, with clamping ring, Packaging unit 10 pcs.		max. cable diameter <sup>1)</sup> PG 13,5  T 3102 005 7 X	
Backshell, right-angled with clamping ring, packaging unit 10 pcs.		max. cable diameter <sup>1)</sup> PG 9  T 3102 015 7 X	max. cable diameter <sup>1)</sup> PG 11  T 3102 014 7 X
Strain relief, max. 12 mm cable diameter, packaging unit 10 pcs.		N 16 110 2000 X	

<sup>1)</sup> Cable outlet in mm, see page 32.



## Summary of Part No.

Part No.	Page	Part No.	Page	Part No.	Page	Part No.	Page
C016 00U000 000 1	26	C016 10E014 003 2	28	C016 10H019 003 2	27	C016 20E005 103 2	28
C016 00U000 000 2	29	C016 10E014 004 2	28	C016 10H019 004 2	27	C016 20E005 104 2	28
C016 00U000 010 2	29	C016 10E014 005 2	28	C016 10H17 003 1	24	C016 20E005 105 2	28
C016 00U000 020 1	26	C016 10E017 002 1	25	C016 10I008 002 1	24	C016 20F005 104 2	28
C016 00V000 000 1	26	C016 10E017 003 1	25	C016 10I008 003 1	24	C016 20G005 100 2	27
C016 00V000 000 2	29	C016 10E019 003 2	28	C016 10I012 003 2	27	C016 20H005 103 2	27
C016 00V000 010 2	29	C016 10E019 004 2	28	C016 10I012 004 2	27	C016 20H005 104 2	27
C016 00V000 020 1	26	C016 10E019 005 2	28	C016 10I012 005 2	27	C016 20I005 103 2	27
C016 10C008 000 1	26	C016 10F008 002 1	25	C016 10I014 002 1	24	C016 20I005 104 2	27
C016 10C012 000 2	28	C016 10F008 003 1	25	C016 10I014 003 1	24	C016 20I005 105 2	27
C016 10C014 000 1	26	C016 10F012 004 2	28	C016 10I014 003 2	27	C016 20K005 104 2	27
C016 10C014 000 2	28	C016 10F014 002 1	25	C016 10I014 004 2	27	FH 0000-016	26
C016 10C017 000 1	26	C016 10F014 003 1	25	C016 10I014 005 2	27	FH 0002-016	29
C016 10C019 000 2	28	C016 10F014 004 2	28	C016 10I017 002 1	24	HN 01 015 0005 (1)	30
C016 10D008 002 1	25	C016 10F017 002 1	25	C016 10I017 003 1	24	HN 01 015 0005 (2)	30
C016 10D008 003 1	25	C016 10F017 003 1	25	C016 10I019 003 2	27	HN 01 015 0039 (1)	30
C016 10D012 003 2	28	C016 10F019 004 2	28	C016 10I019 004 2	27	HN 01 015 0039 (2)	30
C016 10D012 004 2	28	C016 10G008 000 1	25	C016 10I019 005 2	27	HN 01 016 0002 (1)	30
C016 10D014 002 1	25	C016 10G012 000 2	27	C016 10K008 002 1	24	HN 01 016 0002 (2)	30
C016 10D014 003 1	25	C016 10G014 000 1	25	C016 10K008 003 1	24	HN 01 016 0003 (1)	30
C016 10D014 003 2	28	C016 10G014 000 2	27	C016 10K012 004 2	27	HN 01 016 0003 (2)	30
C016 10D014 004 2	28	C016 10G017 000 1	25	C016 10K014 002 1	24	HN 01 016 0004 (1)	30
C016 10D017 002 1	25	C016 10G019 000 2	27	C016 10K014 003 1	24	HN 01 016 0004 (2)	30
C016 10D017 003 1	25	C016 10H008 002 1	24	C016 10K014 004 2	27	HN 01 016 0005 (1)	30
C016 10D019 003 2	28	C016 10H008 003 1	24	C016 10K017 002 1	24	HN 01 016 0005 (2)	30
C016 10D019 004 2	28	C016 10H012 003 2	27	C016 10K017 003 1	24	HN 01 016 0011 (1)	30
C016 10E008 002 1	25	C016 10H012 004 2	27	C016 10K019 004 2	27	HN 01 016 0011 (2)	30
C016 10E008 003 1	25	C016 10H014 002 1	24	C016 10N008 006 1	25	HN 01 025 0001 (1)	30
C016 10E012 003 2	28	C016 10H014 003 1	24	C016 10N014 006 1	25	HN 01 025 0001 (2)	30
C016 10E012 004 2	28	C016 10H014 003 2	27	C016 10N017 006 1	25	HN 01 025 0010 (1)	30
C016 10E012 005 2	28	C016 10H014 004 2	27	C016 20C005 100 2	28	HN 01 025 0010 (2)	30
C016 10E014 002 1	25	C016 10H014 005 2	27	C016 20D005 103 2	28	HN 02 015 0005 (1)	31
C016 10E014 003 1	25	C016 10H017 002 1	24	C016 20D005 104 2	28	HN 02 015 0005 (2)	31

## Summary of Part No.

Part No.	Page	Part No.	Page	Part No.	Page	Part No.	Page
HN 02 015 0039 (1)	31	T 3105 091	12	T 6483 000	14	VN 02 025 0010 (102)	31
HN 02 015 0039 (2)	31	T 3105 100	12	T 6483 001	14	ZN 01 015 0005 (1)	30
HN 02 016 0002 (1)	31	T 3105 101	12	VN 01 015 0005 (1)	30	ZN 01 015 0005 (2)	30
HN 02 016 0002 (2)	31	T 3105 200	12	VN 01 015 0005 (2)	30	ZN 01 015 0039 (1)	30
HN 02 016 0003 (1)	31	T 3105 501	12	VN 01 015 0039 (1)	30	ZN 01 015 0039 (2)	30
HN 02 016 0003 (2)	31	T 3105 581	12	VN 01 015 0039 (2)	30	ZN 01 016 0002 (1)	30
HN 02 016 0005 (1)	31	T 3105 591	12	VN 01 016 0002 (1)	30	ZN 01 016 0002 (2)	30
HN 02 016 0005 (2)	31	T 3105 601	12	VN 01 016 0002 (2)	30	ZN 01 016 0003 (1)	30
HN 02 025 0001 (1)	31	T 3105 701	12	VN 01 016 0003 (1)	30	ZN 01 016 0003 (2)	30
HN 02 025 0001 (2)	31	T 3106 000	13	VN 01 016 0003 (2)	30	ZN 01 016 0004 (1)	30
HN 02 025 0010 (1)	31	T 3106 010	13	VN 01 016 0004 (1)	30	ZN 01 016 0004 (2)	30
HN 02 025 0010 (2)	31	T 3106 500	13	VN 01 016 0004 (2)	30	ZN 01 016 0005 (1)	30
N 16 110 2000 X	14	T 3107 000	11	VN 01 016 0005 (1)	30	ZN 01 016 0005 (2)	30
T 3102 003 7 X	14	T 3107 500	11	VN 01 016 0005 (2)	30	ZN 01 016 0011 (1)	30
T 3102 004 7 X	14	T 3108 000	10	VN 01 016 0011 (1)	30	ZN 01 016 0011 (2)	30
T 3102 005 7 X	14	T 3108 001	10	VN 01 016 0011 (2)	30	ZN 01 025 0001 (1)	30
T 3102 014 7 X	14	T 3108 081	10	VN 01 025 0001 (101)	30	ZN 01 025 0001 (2)	30
T 3102 015 7 X	14	T 3108 091	10	VN 01 025 0001 (102)	30	ZN 01 025 0010 (1)	30
T 3104 000	10	T 3108 100	10	VN 01 025 0010 (101)	30	ZN 01 025 0010 (2)	30
T 3104 001	10	T 3108 101	10	VN 01 025 0010 (102)	30	ZN 02 015 0005 (1)	31
T 3104 081	10	T 3108 200	10	VN 02 015 0005 (1)	31	ZN 02 015 0005 (2)	31
T 3104 091	10	T 3109 000	12	VN 02 015 0005 (2)	31	ZN 02 015 0039 (1)	31
T 3104 100	10	T 3109 001	12	VN 02 015 0039 (1)	31	ZN 02 015 0039 (2)	31
T 3104 101	10	T 3109 081	12	VN 02 015 0039 (2)	31	ZN 02 016 0002 (1)	31
T 3104 200	10	T 3109 091	12	VN 02 016 0002 (1)	31	ZN 02 016 0002 (2)	31
T 3104 501	10	T 3109 100	12	VN 02 016 0002 (2)	31	ZN 02 016 0003 (1)	31
T 3104 581	10	T 3109 101	12	VN 02 016 0003 (1)	31	ZN 02 016 0003 (2)	31
T 3104 591	10	T 3109 200	12	VN 02 016 0003 (2)	31	ZN 02 016 0005 (1)	31
T 3104 601	10	T 3110 000	13	VN 02 016 0005 (1)	31	ZN 02 016 0005 (2)	31
T 3104 701	10	T 3110 010	13	VN 02 016 0005 (2)	31	ZN 02 025 0001 (1)	31
T 3105 000	12	T 3111 000	11	VN 02 025 0001 (101)	31	ZN 02 025 0001 (2)	31
T 3105 001	12	T 6482 000	14	VN 02 025 0001 (102)	31	ZN 02 025 0010 (1)	31
T 3105 081	12	T 6482 001	14	VN 02 025 0010 (101)	31	ZN 02 025 0010 (2)	31