

Amphenol

Amphenol-Tuchel Electronics GmbH

Series C 16-3[®] Circular Connectors



The Company

Amphenol-Tuchel Electronics GmbH is a member of the USA based Amphenol Corporation. With our own global presence we offer our customers exceptional technical support and worldwide service in the areas of development, production and distribution. Amphenol-Tuchel Electronics GmbH has a successful history as a partner to our customers and sets standards for connector technology.



Quality

From the beginning of the development process, Amphenol-Tuchel Electronics GmbH gives quality considerations the top priority. Meeting customer requirements is

the main focus of the product development process.

Interdisciplinary project teams with diverse backgrounds from marketing, product engineering and production guarantee the development and production of robust and reliable connector solutions.

Our quality assessment begins with the initial contact to the customer and extends through the life of the product. A satisfied customer is the measure of our success.

We strive to use environmentally friendly processes that minimize the waste of natural resources and introduction of toxins into the environment.

Certifications: TS 16949
 ISO 14001
 ISO 9000:2000

General information

We reserve the right to change the design due to improvement in quality, development or production requirements.

This catalogue must not be used in any form or manner without our prior approval in writing (Copyright Law, Fair Trading Law, Civil Code).

This release replaces all former releases.

Content

Page

General information

2

Serie C 16-3



Product description

4

Order information
Approvals

5

Coding system

6

Technical data

7

Derating curves

9

View of connector style

10

Assembly instructions

11

Shell size 1

Male cable connectors

12

Female receptacles
Female cable connectors

13

Male receptacles
Accessories

14

Shell size 2

Male cable connectors
Female receptacles

15

Female cable connectors
Male receptacles

16

Accessories

17

EMV versions

18

Crimp contacts pin

21

Crimp contacts socket

22

Part No. system for crimp contacts

23

Technical Information

24

Remarks / Safety classification

27

Summary of Part Numbers

28



Product description

The circular connector series C 16-3 has two housing sizes. The connectors are designed to meet the high requirements of industrial applications under harsh environmental conditions. The range includes versions with screw and crimp terminations. A selection of crimp contacts for hand crimp tools and crimp machines enables a reliable termination relating in qualitative, technical and economical advantages. A board selection of housing styles are available.

On choosing the housing style and shell size please take both the cable diameter and wire gauge into consideration. If necessary one should use the long housing versions.

Main features and advantages:

- Circular connectors for power and signal applications with following contact arrangements:
Shell size 1: 8 + PE, 14 + PE, 17 + PE, 12 + 3 + PE
Shell size 2: 5 + PE, 12 + PE, 14 + PE, 19 + PE
- For applications in machine tools, measurement and control, process technology and medical equipment
- Housing are made from high grade plastic material.
- Vibration safe connection by solid bayonet coupling with lock in position.
- Cable housing straight or right-angled with various cable outlets
- Protection degree IP 65 in mated position.
- Internal cable clamp or clamping ring provides a safe cable restrain.

C 16-3

Product description
Order information
Approvals

Order information

Colour coding

Upon request the coupling ring of the plugs and the housing of the receptacles can be delivered in the colour red, green, blue, yellow and grey.

Polarization

Depending on the contact arrangements the polarization of this connector series can be varied. The contact inserts can be mounted in alternate positions. The order number in the catalogue refers always to position 1. The position of the contact inserts can also be changed by the customer using a disassembly tool (see page 14 and 17) to remove the insert and remount it in the required position (see page 6)

Crimp version

Order numbers do not include crimp contacts. Please order separately (page 21 / 22)

Crimp tooling

Ask for our catalogue "Tools".

Testhouse

Approvals

Approval No.

VDE



3964

UL ¹⁾



E 63093

CSA



49932-9

In general approvals refer to representative versions of the connector series. Test report upon request.

¹⁾ Please refer to the „Conditions of Acceptability“.

C 16-3

Coding system

Polarization

Depending on the contact arrangements the polarization of this connector series can be varied. Please take care of the housing and contact insert characteristics.

Shell size 1			Shell size 2		
No of contacts	No of coding possibil.	Position	No of contacts	No of coding possibil.	Position
8 + PE	4	1, 3, 5, 7	5 + PE	6	1, 2, 3, 4, 6, 7
14 + PE	7	1, 2, 3, 4, 5, 6, 7	14 + PE	7	1, 2, 3, 4, 5, 6, 7
17 + PE	6	1, 2, 3, 4, 5, 7	12 + PE	7	1, 2, 3, 4, 5, 6, 7
12 + 3 + PE	4	1, 3, 5, 7	19 + PE	6	1, 3, 4, 5, 6, 7

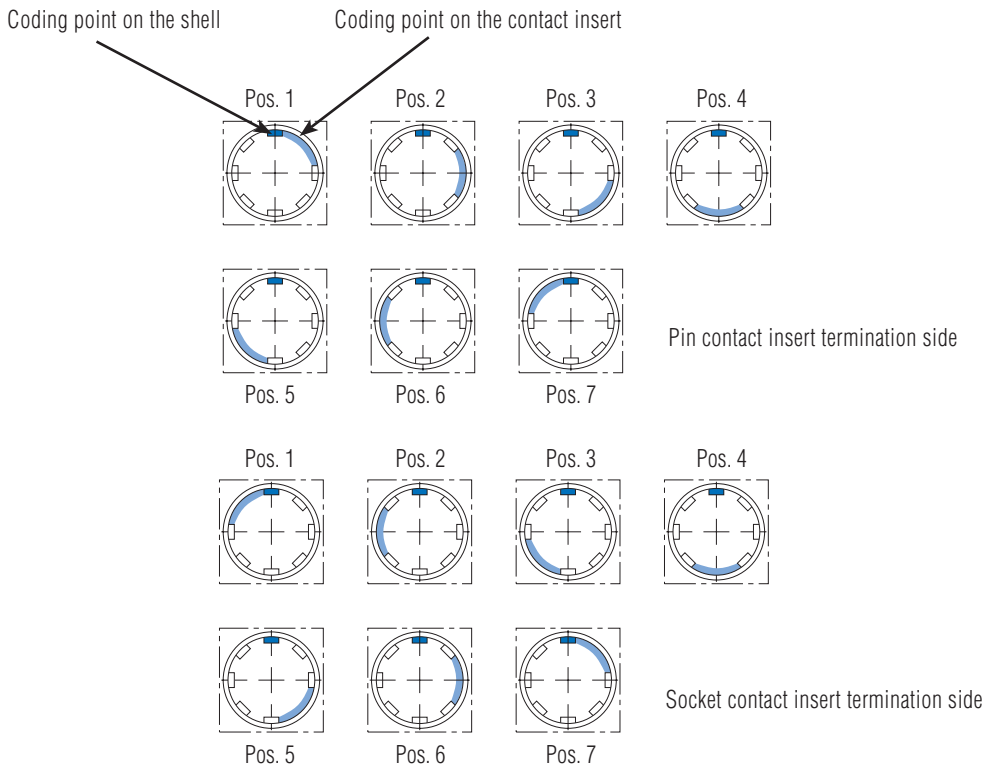

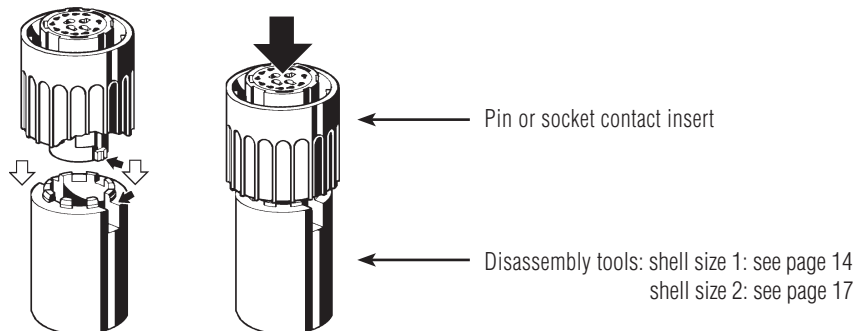

Disassembly of contact inserts with disassembly tool (see page 14 and 17)

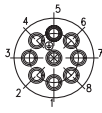
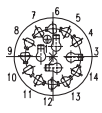

C 16-3

Technical data Shell size 1





General Characteristics		Standard		Technical data			
				Shell size 1			
Number of contacts				8 + PE	14 + PE	17 + PE	12 + 3 + PE
							
Electrical Characteristics							
Rated voltage	DIN EN 60664-1 ¹⁾	400 V	100 V	100 V	3 x 320 V, 12 x 24 V		
	UL 1977, CSA 22.2	400 V	3 x 250 V, 11 x 250 V	250 V	3 x 250 V, 12 x 24 V		
Rated impulse withstand voltage	DIN EN 60664-1 ¹⁾	6000 V	3000 V	3000 V	3 x 4000 V, 12 x 800 V		
Pollution degree	DIN EN 60664-1 ¹⁾	3	3	3	3		
Installation (overvoltage) category	DIN EN 60664-1 ¹⁾	III	III	III	III		
Material group	DIN EN 60664-1 ¹⁾	II	II	II	II		
Current carrying capacity	DIN EN 60512-5-2, test 5b	12 A	3 x 16 A, 11 x 6 A	6 A	3 x 12 A, 12 x 6 A		
	UL 1977, CSA 22.2	10 A	3 x 12 A, 11 x 4 A	5 A	3 x 10 A, 12 x 5 A		
Insulation resistance	DIN EN 60512-3-1, test 3a	≥ 10 ⁸ Ω					
Contact resistance	DIN EN 60512-2-1, test 2a	≤ 5 mΩ					
Climatic Characteristics							
Climatic category	DIN EN 60068-1	40 / 125 / 56					
Operating temperature		-40°C ... +125°C					
Mechanical Characteristics							
Degree of protection	DIN EN 60529	IP 65					
Insertion and withdrawal force	DIN EN 60512-13-2, test 13b	≤ 25 N	≤ 30 N	≤ 22 N	≤ 25 N		
Mechanical operation	IEC 60512, test 9a	≥ 500 mating cycles					
Materials							
Housing material		Polyamide 6.6					
Dielectric material		Polyamide 6.6					
Gasket material		Neoprene					
Contact plating		silver plated / gold plated					
Other Characteristics							
Termination technique		crimp					
Wire gauge / AWG		0,14 - 2,5 mm ² / 26 - 14	0,09 - 2,5 mm ² / 28 - 14	0,09 - 1,0 mm ² / 28 - 18	0,09 - 2,5 mm ² / 28 - 14		
Flammability	UL 94	VO					
Locking system		bayonet					

¹⁾ DIN 60664-1 ≙ VDE 0110-1 ≙ DIN EN 60664-1

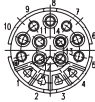

C 16-3

Technical data Shell size 2

General Characteristics	Standard	Technical data			
		Shell size 2			
Number of contacts		5 + PE	12 + PE	14 + PE	19 + PE
					
Electrical Characteristics					
Rated voltage	DIN EN 60664-1 ¹⁾	400 V	3 x 500 V, 9 x 300 V	400 V	250 V
	UL 1977, CSA 22.2	400 V	3 x 400 V, 9 x 250 V	10 x 400 V, 4 x 250 V	250 V
Rated impulse withstand voltage	DIN EN 60664-1 ¹⁾	6000 V	3 x 6000 V, 9 x 4000 V	6000 V	4000 V
Pollution degree	DIN EN 60664-1 ¹⁾	3	3	3	3
Installation (overvoltage) category	DIN EN 60664-1 ¹⁾	III	III	III	III
Material group	DIN EN 60664-1 ¹⁾	II	II	II	II
Current carrying capacity	DIN EN 60512-5-2, test 5b	21 A	3 x 21 A, 9 x 11 A	4 x 6 A, 10 x 12 A	6 A
	UL 1977, CSA 22.2	16 A	3 x 10 A, 9 x 5 A	10 x 10 A, 4 x 5 A	5 A
Insulation resistance	DIN EN 60512-3-1, test 3a	≥ 10 ⁸ Ω			
Contact resistance	DIN EN 60512-2-1, test 2a	≤ 5 mΩ			
Climatic Characteristics					
Climatic category	DIN EN 60068-1	40/100/56	40 / 125 / 56		
Operating temperature		-40°C ... +125°C (5+PE: +100°C)			
Mechanical Characteristics					
Degree of protection	DIN EN 60529	IP 65			
Insertion and withdrawal force	DIN EN 60512-13-2, test 13b	≤ 15 N	≤ 25 N	≤ 30 N	≤ 25 N
Mechanical operation	DIN EN 60512-9-1, test 9a	≥ 500 mating cycles			
Materials					
Housing material		Polyamide 6.6			
Dielectric material		Poliamide 6.6			
Gasket material		Neoprene			
Contact plating		silver plated/ gold plated			
Other Characteristics					
Termination technique		screw	crimp		
Wire gauge / AWG		4 mm ² / 10	0,09 - 2,5 mm ² / 28 - 14	0,09 - 2,5 mm ² / 28 - 14	0,09 - 1,0 mm ² / 28 - 18
Flammability	UL 94	VO			
Locking system		bayonet			

¹⁾ DIN EN 60664-1 ≙ VDE 0110-1 ≙ IEC 60664-1



C 16-3

Derating curves

Shell size 1

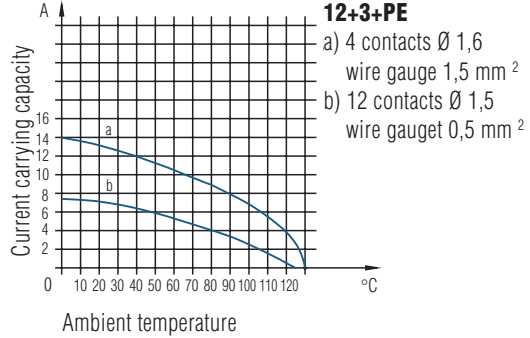
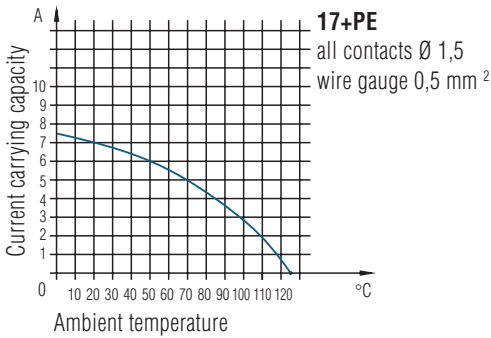
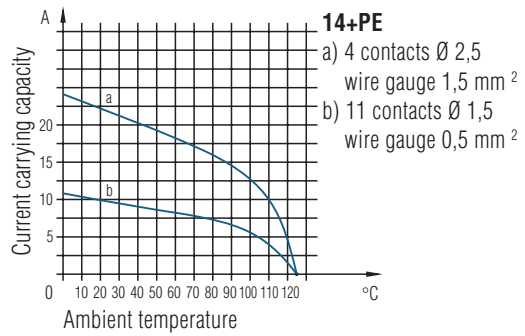
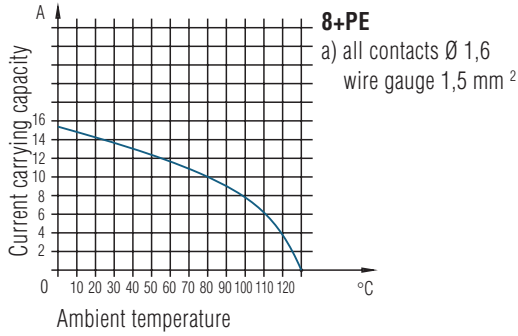



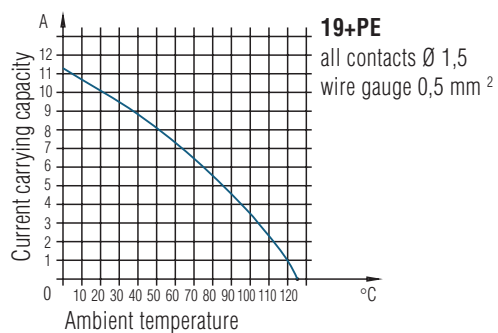
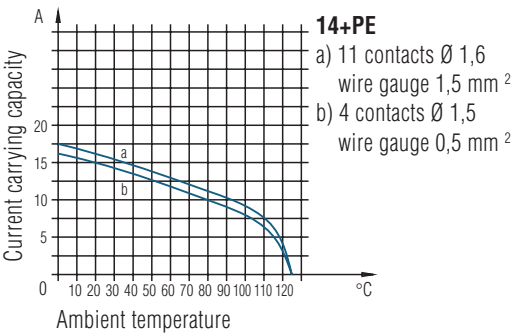
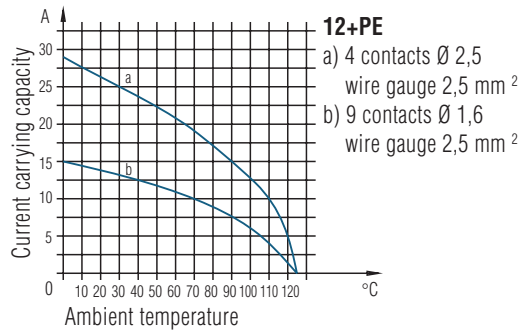
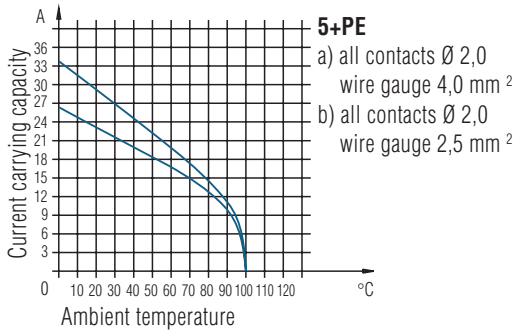





Shell size 2



C 16-3

Male cable connector,
Shell size 1 and 2

Identification	Figure	Description	Conn. Style	Page	
				Size 1	Size 2
Male cable connector		Long version with internal cable clamp	I	12	15
		Short version, with clamping ring	H	12	15
		Right -angled, with clamping ring	K	12	15
Female cable connector		Long version with internal cable clamp	E	13	16
		Short version, with clamping ring	D	13	16
		Right-angled, with clamping ring	F	13	16
Female receptacle		Flange mounting, with mounted gasket	G	13	15
		Panel mounting with ring nut, with gasket	N	13	–
Male receptacle		Flange mounting, with mounted gasket	C	14	16

C 16-3

Assembly instructions Shell size 1 and 2

Torque for back shell and cable screw
min. 1 Nm
max. 2 Nm

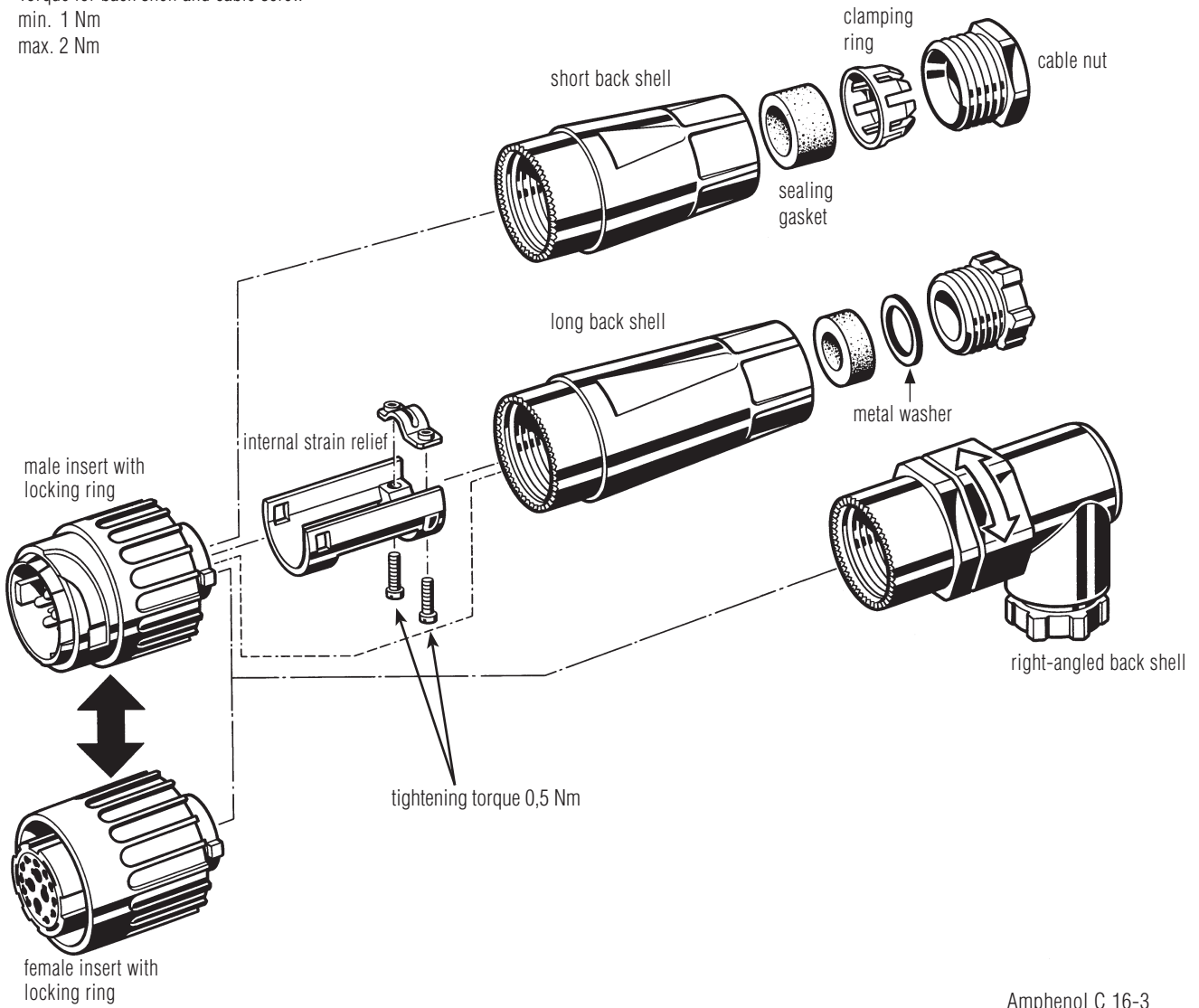

Shinning lengths

Screw contacts		7,0 ⁺¹ mm ¹⁾
Crimp contacts	0,09 - 0,25 mm ²	3 ^{+0,5} mm
	0,35 - 0,50 mm ²	3 ^{+0,5} mm
	0,50 - 2,50 mm ²	3,5 ⁺¹ mm

¹⁾ end splice recommended

Remarks:

The dimensions are for general information only and can vary depending on cable styles and types. Please make sure that the usability of the cable in conjunction with the clamping ring is given.

C 16-3

Shell size 1 Male cable connectors



I



H



K

Description	Drawing	No. of cont.	Contacts ²⁾	Part No. Cable outlet	
				Ø 10-12	Ø 12-14
Male cable connector for crimp contacts, long, style I with internal cable clamp, without contacts ¹⁾		8 + PE	.N 01 016 00...	C016 10I008 002 1	C016 10I008 003 1
		14 + PE	11 x .N 01 015 00... 4 x .N 01 025 00...	C016 10I014 002 1	C016 10I014 003 1
		12+3+PE	12 x .N 01 015 00... 4 x .N 01 016 00...	C016 10I015 002 1	C016 10I015 003 1
		17 + PE	.N 01 015 00...	C016 10I017 002 1	C016 10I017 003 1
				Cable outlet	
				Ø 8-10	Ø 10-12
Male cable connector for crimp contacts, short, style H with clamping ring, without contacts ¹⁾		8 + PE	.N 01 016 00...	C016 10H008 002 1	C016 10H008 003 1
		14 + PE	11 x .N 01 015 00... 4 x .N 01 025 00...	C016 10H014 002 1	C016 10H014 003 1
		12+3+PE	12 x .N 01 015 00... 4 x .N 01 016 00...	C016 10H015 002 1	C016 10H015 003 1
		17 + PE	.N 01 015 00...	C016 10H017 002 1	C016 10H017 003 1
Male cable connector for crimp contacts, style K with clamping ring, without contacts ¹⁾		8 + PE	.N 01 016 00...	C016 10K008 002 1	C016 10K008 003 1
		14 + PE	11 x .N 01 015 00... 4 x .N 01 025 00...	C016 10K014 002 1	C016 10K014 003 1
		12+3+PE	12 x .N 01 015 00... 4 x .N 01 016 00...	C016 10K015 002 1	C016 10K015 003 1
		17 + PE	.N 01 015 00...	C016 10K017 002 1	C016 10K017 003 1

¹⁾ Please order crimp contacts separately, see page 21/22.

²⁾ Part No system for crimp contacts, see page 23.

C 16-3

Shell size 1 Female receptacles

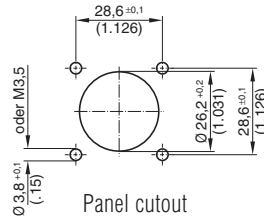

G

Panel cutout

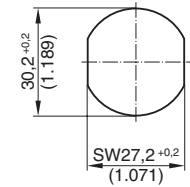

N

Panel cutout

Description	Drawing	No. of cont.	Contacts ²⁾	Part No.
Female receptacle for crimp contacts, style G, without contacts ¹⁾		8 + PE	.N 02 016 00...	C016 10G008 000 1
		14 + PE	11 x .N 02 015 00... 4 x .N 02 025 00...	C016 10G014 000 1
		12+3+PE	12 x .N 02 015 00... 4 x .N 02 016 00...	C016 10G015 000 1
		17 + PE	.N 02 015 00...	C016 10G017 000 1
Female receptacle for crimp contacts, style N, without contacts ¹⁾		8 + PE	.N 02 016 00...	C016 10N008 006 1
		14 + PE	11 x .N 02 015 00... 4 x .N 02 025 00...	C016 10N014 006 1
		12+3+PE	12 x .N 02 015 00... 4 x .N 02 016 00...	C016 10N015 006 1
		17 + PE	.N 02 015 00...	C016 10N017 006 1

C 16-3

Shell size 1 Female cable connectors



E



D



F

Description	Drawing	No. of cont.	Contacts ²⁾	Part No. Cable outlet	
				Ø 10-12	Ø 12-14
Female cable connector for crimp contacts, long, style E with internal strain relief, without contacts ¹⁾		8 + PE	.N 02 016 00...	C016 10E008 002 1	C016 10E008 003 1
		14 + PE	11 x .N 02 015 00... 4 x .N 02 025 00...	C016 10E014 002 1	C016 10E014 003 1
		12+3+PE	12 x .N 02 015 00... 4 x .N 02 016 00...	C016 10E015 002 1	C016 10E015 003 1
		17 + PE	.N 02 015 00...	C016 10E017 002 1	C016 10E017 003 1
				Cable outlet	
				Ø 8-10	Ø 10-12
Female cable connector for crimp contacts, short, style D with clamping ring, without contacts ¹⁾		8 + PE	.N 02 016 00...	C016 10D008 002 1	C016 10D008 003 1
		14 + PE	11 x .N 02 015 00... 4 x .N 02 025 00...	C016 10D014 002 1	C016 10D014 003 1
		12+3+PE	12 x .N 02 015 00... 4 x .N 02 016 00...	C016 10D015 002 1	C016 10D015 003 1
		17 + PE	.N 02 015 00...	C016 10D017 002 1	C016 10D017 003 1
Female cable connector for crimp contacts, style F with clamping ring, without contacts ¹⁾		8 + PE	.N 02 016 00...	C016 10F008 002 1	C016 10F008 003 1
		14 + PE	11 x .N 02 015 00... 4 x .N 02 025 00...	C016 10F014 002 1	C016 10F014 003 1
		12+3+PE	12 x .N 02 015 00... 4 x .N 02 016 00...	C016 10F015 002 1	C016 10F015 003 1
		17 + PE	.N 02 015 0005	C016 10F017 002 1	C016 10F017 003 1

¹⁾ Please order crimp contacts separately, see page 21/22.

²⁾ Part No system for crimp contacts, see page 23.

C 16-3

Shell size 1 Male receptacles



C

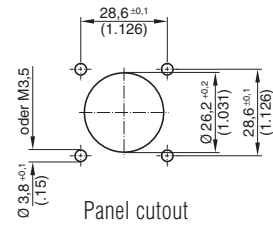

Description	Drawing	No. of cont.	Contacts ²⁾	Part No.
Male receptacle for crimp contacts, style C, without contacts ¹⁾		8 + PE	.N01 016 00...	C016 10C008 000 1
		14 + PE	11 x .N01 015 00... 4 x .N01 025 00...	C016 10C014 000 1
		12 + 3 + PE	12 x .N01 015 00... 4 x .N01 016 00...	C016 10C015 000 1
		17 + PE	.N01 015 00...	C016 10C017 000 1

C 16-3

Shell size 1 Accessories



Description	Drawing	Part No.	
Protective cap for male cable connector and male receptacle		for male cable connector C016 00U000 001 1	for male receptacle C016 00U000 021 1
Protective cap for female cable connector and female receptacle		for male cable connector C016 00V000 001 1	for male receptacle C016 00V000 021 1
Disassembly tool for pin- and socket inserts		FH 0000-016	

¹⁾ Please order crimp contacts separately, see page 21/22.

²⁾ Part No system for crimp contacts, see page 23.

C 16-3

Shell size 2 Male cable connectors



Description	Drawing	No. of cont.	Contacts ²⁾	Part No. Cable outlet ³⁾		
				Ø 12-14	Ø 14-16	Ø 19-21
Male cable connector, long, style I with internal strain relief, 5 + PE screw termination, 12 + PE-, 14 + PE and 19 + PE-version without contacts ¹⁾		5 + PE	–	C016 20I005 103 2	C016 20I005 104 2	C016 20I005 105 2
		12 + PE	9 x .N 01 016 00... 4 x .N 01 025 00...	C016 10I012 003 2	C016 10I012 004 2	C016 10I012 005 2
		14 + PE	4 x .N 01 015 00... 11 x .N 01 016 00...	C016 10I014 003 2	C016 10I014 004 2	C016 10I014 005 2
		19 + PE	.N 01 015 000...	C016 10I019 003 2	C016 10I019 004 2	C016 10I019 005 2
				Cable outlet		
				Ø 10-12	Ø 12-14	Ø 14-18
Male cable connector, short, style H with clamping ring, 5 + PE screw termination, 12 + PE-, 14 + PE and 19 + PE-version without contacts ¹⁾		5 + PE	–	C016 20H005 103 2	C016 20H005 104 2	–
		12 + PE	9 x .N 01 016 00... 4 x .N 01 025 00...	C016 10H012 003 2	C016 10H012 004 2	–
		14 + PE	4 x .N 01 015 00... 11 x .N 01 016 00...	C016 10H014 003 2	C016 10H014 004 2	C016 10H014 005 2
		19 + PE	.N 01 015 00...	C016 10H019 003 2	C016 10H019 004 2	–
Male cable connector, style K with clamping ring, 5 + PE screw termination, 12 + PE-, 14 + PE and 19 + PE-version without contacts ¹⁾		5 + PE	–	–	C016 20K005 104 2	–
		12 + PE	9 x .N 01 016 00... 4 x .N 01 025 00...	–	C016 10K012 004 2	–
		14 + PE	4 x .N 01 015 00... 11 x .N 01 016 00...	–	C016 10K014 004 2	–
		19 + PE	.N 01 015 00...	–	C016 10K019 004 2	–

C 16-3

Shell size 2 Female receptacle



G

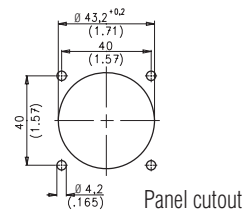

Panel cutout

Description	Drawing	No. of cont.	Contacts ²⁾	Part No.
Female receptacle, style G, 5 + PE screw termination, 12 + PE-, 14 + PE and 19 + PE version without contacts ¹⁾		5 + PE	–	C016 20G005 100 2
		12 + PE	9 x .N 02 016 00... 4 x .N 02 025 00...	C016 10G012 000 2
		14 + PE	4 x .N 02 015 00... 11 x .N 02 016 00...	C016 10G014 000 2
		19 + PE	.N 02 015 00...	C016 10G019 000 2

¹⁾ Please order crimp contacts separately, see pag 21/22. ²⁾ Part No system for crimp contacts, see page 23.

C 16-3

Shell size 2 Female cable connectors



Description	Drawing	No. of cont.	Contacts ²⁾	Part No. Cable outlet ³⁾		
				Ø 12-14	Ø 14-16	Ø 19-21
Female cable connector, long, style E with internal strain relief, 5 + PE screw termination, 12 + PE-, 14 + PE and 19 + PE-version without contacts ¹⁾		5 + PE	-	C016 20E005 103 2	C016 20E005 104 2	C016 20E005 105 2
		12 + PE	9 x .N 02 016 00... 4 x .N 02 025 00...	C016 10E012 003 2	C016 10E012 004 2	C016 10E012 005 2
		14 + PE	4 x .N 02 015 00... 11 x .N 02 016 00...	C016 10E014 003 2	C016 10E014 004 2	C016 10E014 005 2
		19 + PE	.N 02 015 00...	C016 10E019 003 2	C016 10E019 004 2	C016 10E019 005 2
				Cable outlet		
				Ø 10-12	Ø 12-14	
Female cable connector, short, style D with clamping ring, 5 + PE screw termination, 12 + PE-, 14 + PE and 19 + PE-version without contacts ¹⁾		5 + PE	-	C016 20D005 103 2	C016 20D005 104 2	-
		12 + PE	9 x .N 02 016 00... 4 x .N 02 025 00...	C016 10D012 003 2	C016 10D012 004 2	-
		14 + PE	4 x .N 02 015 00... 11 x .N 02 016 00...	C016 10D014 003 2	C016 10D014 004 2	-
		19 + PE	.N 02 015 00...	C016 10D019 003 2	C016 10D019 004 2	-
Female cable connector, style F with clamping ring, 5 + PE screw termination, 12 + PE-, 14 + PE and 19 + PE-version without contacts ¹⁾		5 + PE	-	-	C016 20F005 104 2	-
		12 + PE	9 x .N 02 016 00... 4 x .N 02 025 00...	-	C016 10F012 004 2	-
		14 + PE	4 x .N 02 015 00... 11 x .N 02 016 00...	-	C016 10F014 004 2	-
		19 + PE	.N 02 015 00...	-	C016 10F019 004 2	-

C 16-3

Shell size 2 Male receptacle

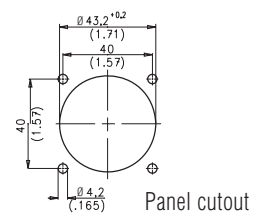

Description	Drawing	No. of cont.	Contacts ²⁾	Part No.
Male receptacle, style C, 5 + PE screw termination, 12 + PE-, 14 + PE and 19 + PE-version without contacts ¹⁾		5 + PE	-	C016 20C005 100 2
		12 + PE	9 x .N 01 016 00... 4 x .N 01 015 00...	C016 10C012 000 2
		14 + PE	4 x .N 01 015 00... 11 x .N 01 016 00...	C016 10C014 000 2
		19 + PE	.N 01 015 00...	C016 10C019 000 2



¹⁾ Please order crimp contacts separately, see page 21/22.

²⁾ Part No system for crimp contacts, see page 23.

C 16-3

Shell size 2 Accessories

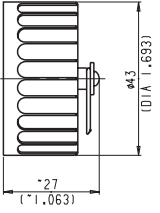
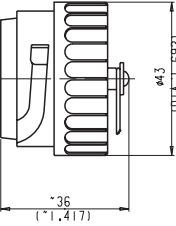

Description	Figure	Part No.	
Protective cap for male cable connector and male receptacle		for male cable connector C016 00U000 011 2	for male receptacle C016 00U000 001 2
Protective cap for female cable connector and female receptacle		for female cable connector C016 00V000 011 2	for female receptacle C016 00V000 001 2
Disassembly tool for pin-and socket inserts		FH 0002-016	

C 16-3 EMV

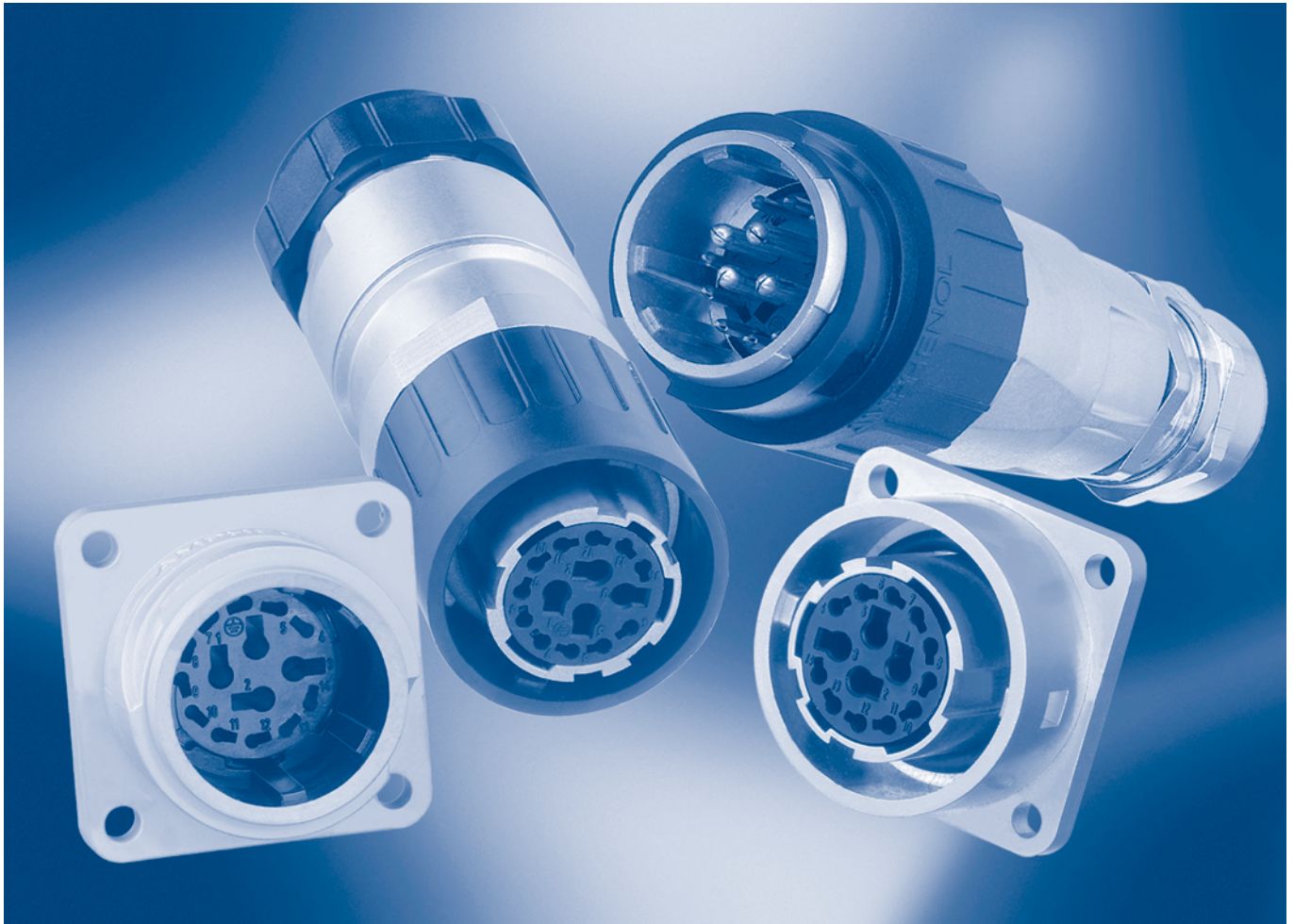

Product description

The C 16-3 EMI connectors excel by versatile fields of application, especially high mechanical requirements, industrial environments and demands for safe contact.

Main features:

- high attenuation of shielding
- contact inserts suitable for standard and EMI versions
- completely compatible with standard C 16-3, size 1
- same technical characteristics as standard C 16-3, see page 7
- mechanical lifetime: 100 mating cycles
- we recommend the usage of the versions with two-part metal housing in very harsh environmental conditions

Two versions available:

1. Version with metalized plastic housing accord. VDE 0610.
PE wire is connected to cable shield and housing. In case of error the current will be lead directly to the PE wire
2. Combined version with metalized plastic and two-part metal housing accord. VDE 0113. PE wire is securely and firmly connected with the metal housing.

Crimp version

Order numbers do not include crimp contacts. Please order separately (see page 21/22).

Crimp contact for higher currents are available upon request.

Crimp tooling

Ask for our catalogue "Tools".

Testhouse

Approval

Approval No.

UL ¹⁾



E 63093

¹⁾ Please refer to the „Conditions of Acceptability“

C 16-3 EMV

Shell size 1



Description	Drawing	No. of cont.	Contacts ²⁾	Part No. Cable outlet	
				Ø max. 10.5	Ø max. 12.5
Male cable connector, style H, without contacts ¹⁾ , without cable screw, metalized plastic housing		8 + PE	.N 01 016 00...	C016 10H008 012 5	C016 10H008 013 5
		14 + PE	11 x .N 01 015 00... 4 x .N 01 025 00...	C016 10H014 012 5	C016 10H014 013 5
		12+3+PE	12 x .N 01 015 00... 4 x .N 01 016 00...	C016 10H015 012 5	C016 10H015 013 5
		17 + PE	.N 01 015 00...	C016 10H017 012 5	C016 10H017 013 5
Female cable connector, style D, without contacts ¹⁾ , without cable screw, metalized plastic housing		8 + PE	.N 02 016 00...	C016 10D008 012 5	C016 10D008 013 5
		14 + PE	11 x .N 02 015 00... 4 x .N 02 025 00...	C016 10D014 012 5	C016 10D014 013 5
		12+3+PE	12 x .N 02 015 00... 4 x .N 02 016 00...	C016 10D015 012 5	C016 10D015 013 5
		17 + PE	.N 02 015 00...	C016 10D017 012 5	C016 10D017 013 5
Cable outlet Ø 9-11					
Male cable connector, without contacts ¹⁾ , two part metal housing, with PE contact		8 + PE	.N 01 016 00...	C016 10H008 801 3	
		14 + PE	11 x .N 01 015 00... 4 x .N 01 025 00...	C016 10H014 801 3	
		12+3+PE	12 x .N 01 015 00... 4 x .N 01 016 00...	C016 10H015 801 3	
		17 + PE	.N 01 015 00...	C016 10H017 801 3	
Female cable connector, without contacts ¹⁾ , two part metal housing, with PE contact.		8 + PE	.N 02 016 00...	C016 10D008 801 3	
		14 + PE	11 x .N 02 015 00... 4 x .N 02 025 00...	C016 10D014 801 3	
		12+3+PE	12 x .N 02 015 00... 4 x .N 02 016 00...	C016 10D015 801 3	
		17 + PE	.N 02 015 00...	C016 10D017 801 3	

¹⁾ Please order crimp contacts separately, see page 21/22.

²⁾ Part No system for crimp contacts, see page 23.

C 16-3 EMV

Shell size 1

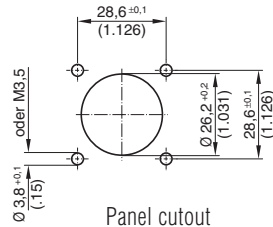
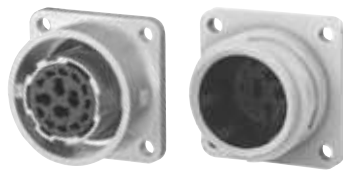

Panel cutout

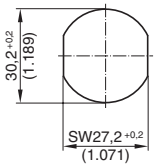

Panel cutout

Description	Drawing	No. of cont.	Contacts ²⁾	Part No.
Female receptacle, style G, without contacts ¹⁾		8 + PE	.N 02 016 00...	C016 10G008 000 5
		14 + PE	11 x.N 02 015 00... 4 x.N 02 025 00...	C016 10G014 000 5
		12+3+PE	12 x .N 02 015 00... 4 x .N 02 016 00...	C016 10G015 000 5
		17 + PE	.N 02 015 00...	C016 10G017 000 5
Female receptacle, style N, without contacts ¹⁾		8 + PE	.N 02 016 00...	C016 10N008 000 5
		14 + PE	11 x.N 02 015 00... 4 x.N 02 025 00...	C016 10N014 000 5
		12+3+PE	12 x .N 02 015 00... 4 x .N 02 016 00...	C016 10N015 000 5
		17 + PE	.N 02 015 00...	C016 10N017 000 5
Male receptacle, style C, without contacts 1)		8 + PE	.N 01 016 00...	C016 10C008 000 5
		14 + PE	11 x.N 01 015 00... 4 x.N 01 025 00...	C016 10C014 000 5
		12+3+PE	12 x .N 01 015 00... 4 x .N 01 016 00...	C016 10C015 000 5
		17 + PE	.N 01 015 00...	C016 10C017 000 5

Assembly instructions metal housing

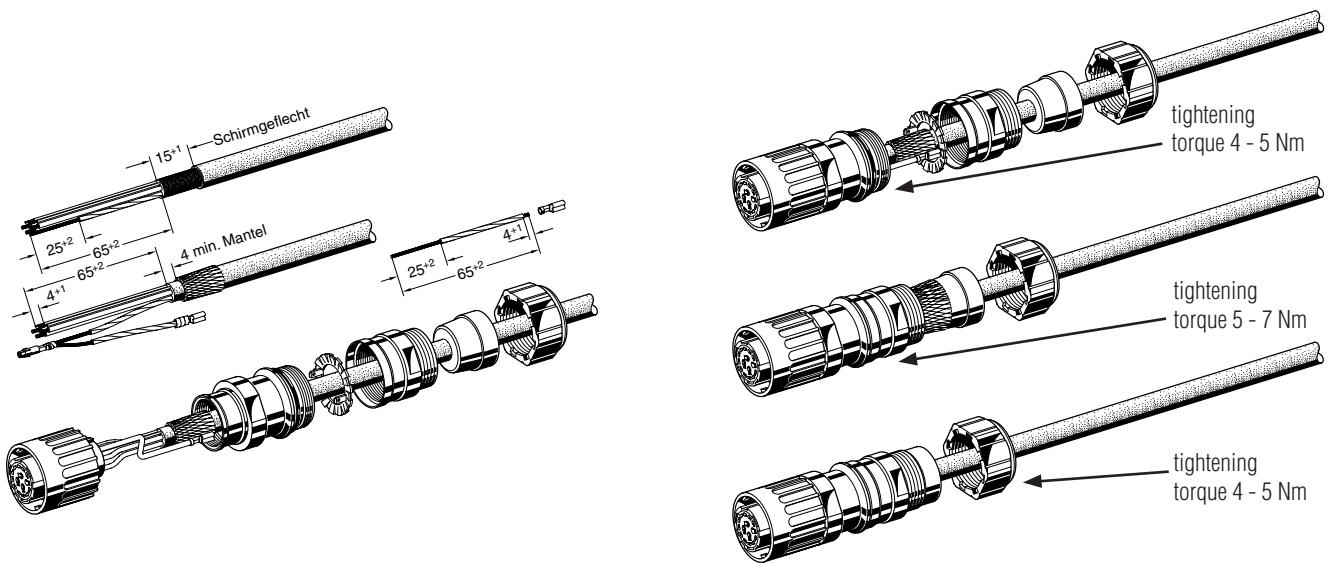

16-3

Crimp contacts Pin

Stamped single contacts



Stamped contacts on reel for
hand crimping tools



100 resp. 200 pcs

Stamped contacts on reel for crimp machines



2000 pcs.
(feeding left or
right hand side)

Series	Contact Ø in mm	Isulation Ø in mm	No. of cont.	Shell size	Wire gauge in mm ² AWG	Supplied as	pcs.	Part No. Contact plating			
								silver	gold		
C 16-3	1,5	0,7 - 1,6	14 + PE	1	0,09 - 0,25 mm ² 28 - 24	single contact	100	VN 01 015 0052 (1)	VN 01 015 0052 (2)		
			12 + 3 + PE	1		contacts on reel	200	ZN 01 015 0052 (1)	ZN 01 015 0052 (2)		
			17 + PE	1		right	2000	HN 01 015 0052 (1)	HN 01 015 0052 (2)		
			14 + PE	2		left	2000	TN 01 015 0052 (1)	TN 01 015 0052 (2)		
			19 + PE	2							
C 16-3	1,5	1,3 - 2,0	14 + PE	1	0,35 - 0,5 mm ² 22 - 20	single contact	100	VN 01 015 0046 (1)	VN 01 015 0046 (2)		
			12 + 3 + PE	1		contacts on reel	200	ZN 01 015 0046 (1)	ZN 01 015 0046 (2)		
			17 + PE	1		right	2000	HN 01 015 0046 (1)	HN 01 015 0046 (2)		
			14 + PE	2		left	2000	TN 01 015 0046 (1)	TN 01 015 0046 (2)		
			19 + PE	2							
C 16-3	1,5	1,6 - 2,1	14 + PE	1	0,75 - 1,0 mm ² 18	single contact	100	VN 01 015 0047 (1)	VN 01 015 0047 (2)		
			12 + 3 + PE	1		contacts on reel	200	ZN 01 015 0047 (1)	ZN 01 015 0047 (2)		
			17 + PE	1		right	2000	HN 01 015 0047 (1)	HN 01 015 0047 (2)		
			14 + PE	2		left	2000	TN 01 015 0047 (1)	TN 01 015 0047 (2)		
			19 + PE	2							
C 16-3	1,6	1,0 - 2,0	8 + PE	1	0,14 - 0,5 mm ² 26 - 20	single contact	100	VN 01 016 0003 (1)	VN 01 016 0003 (2)		
			12 + 3 + PE	1		contacts on reel	200	ZN 01 016 0003 (1)	ZN 01 016 0003 (2)		
			12 + PE	2		right	2000	HN 01 016 0003 (1)	HN 01 016 0003 (2)		
			14 + PE	2		left	2000	TN 01 016 0003 (1)	TN 01 016 0003 (2)		
C 16-3	1,6	1,8 - 2,8	8 + PE	1	0,5 - 1,5 mm ² 20 - 16	single contact	100	VN 01 016 0002 (1)	VN 01 016 0002 (2)		
			12 + 3 + PE	1		contacts on reel	100	ZN 01 016 0002 (1)	ZN 01 016 0002 (2)		
			12 + PE	2		right	2000	HN 01 016 0002 (1)	HN 01 016 0002 (2)		
			14 + PE	2		left	2000	TN 01 016 0002 (1)	TN 01 016 0002 (2)		
C 16-3	1,6	2,5 - 3,5	8 + PE	1	1,5 - 2,5 mm ² 16 - 14	single contact	100	VN 01 016 0005 (1)	VN 01 016 0005 (2)		
			12 + 3 + PE	1		contacts on reel	200	ZN 01 016 0005 (1)	ZN 01 016 0005 (2)		
			12 + PE	2		right	2000	HN 01 016 0005 (1)	HN 01 016 0005 (2)		
			14 + PE	2		left	2000	TN 01 016 0005 (1)	TN 01 016 0005 (2)		
C 16-3	2,5	1,8 - 2,8	14 + PE	1	0,5 - 1,5 mm ² 20 - 16	single contact	100	VN 01 025 0001 (101)	VN 01 025 0001 (102)		
			12 + PE	2		contacts on reel	100	ZN 01 025 0001 (1)	ZN 01 025 0001 (2)		
						right	2000	HN 01 025 0001 (1)	HN 01 025 0001 (2)		
						left	2000	TN 01 025 0001 (1)	TN 01 025 0001 (2)		
	2,5 - 3,5	1,8 - 2,8	14 + PE	1	1,5 - 2,5 mm ² 16 - 14	single contact	100	VN 01 025 0010 (101)	VN 01 025 0010 (102)		
						12 + PE	2	contacts on reel	200	ZN 01 025 0010 (1)	ZN 01 025 0010 (2)
								right	2000	HN 01 025 0010 (1)	HN 01 025 0010 (2)
								left	2000	TN 01 025 0010 (1)	TN 01 025 0010 (2)

Single contact in plastic bag; stamped contact on reel – HN = feeding right side / TN = feeding left side

16-3

Crimp contacts Socket

Stamped single contacts



Stamped contacts on reel
for hand crimping tools



100 resp. 200 pcs

Stamped contacts on reel for crimp machines



2000 pcs.
(feeding left or
right hand side)

Series	Contact Ø in mm	Insulation Ø in mm	No. of cont.	Shell size	Wire gauge in mm ² AWG	Supplied as	pcs.	Part No. Contact plating		
								silver	gold	
C 16-3	1,5	0,7 - 1,6	14 + PE	1	0,09 - 0,25 mm ² 28 - 24	single contact	100	VN 02 015 0052 (1)	VN 02 015 0052 (2)	
			12 + 3 + PE	1		contacts on reel	200	ZN 02 015 0052 (1)	ZN 02 015 0052 (2)	
			17 + PE	1		right	2000	HN 02 015 0052 (1)	HN 02 015 0052 (2)	
			14 + PE	2		left	2000	TN 02 015 0052 (1)	TN 02 015 0052 (2)	
			19 + PE	2						
C 16-3	1,5	1,3 - 2,0	14 + PE	1	0,35 - 0,5 mm ² 22 - 20	single contact	100	VN 02 015 0046 (1)	VN 02 015 0046 (2)	
			12 + 3 + PE	1		contacts on reel	200	ZN 02 015 0046 (1)	ZN 02 015 0046 (2)	
			17 + PE	1		right	2000	HN 02 015 0046 (1)	HN 02 015 0046 (2)	
			14 + PE	2		left	2000	TN 02 015 0046 (1)	TN 02 015 0046 (2)	
			19 + PE	2						
C 16-3	1,5	1,6 - 2,1	14 + PE	1	0,75 - 1,0 mm ² 18	single contact	100	VN 02 015 0047 (1)	VN 02 015 0047 (2)	
			12 + 3 + PE	1		contacts on reel	200	ZN 02 015 0047 (1)	ZN 02 015 0047 (2)	
			17 + PE	1		right	2000	HN 02 015 0047 (1)	HN 02 015 0047 (2)	
			14 + PE	2		left	2000	TN 02 015 0047 (1)	TN 02 015 0047 (2)	
			19 + PE	2						
C 16-3	1,6	1,0 - 2,0	8 + PE	1	0,14 - 0,5 mm ² 26 - 20	single contact	100	VN 02 016 0003 (1)	VN 02 016 0003 (2)	
			12 + 3 + PE	1		contacts on reel	200	ZN 02 016 0003 (1)	ZN 02 016 0003 (2)	
			12 + PE	2		right	2000	HN 02 016 0003 (1)	HN 02 016 0003 (2)	
			14 + PE	2		left	2000	TN 02 016 0003 (1)	TN 02 016 0003 (2)	
C 16-3	1,6	1,8 - 2,8	8 + PE	1	0,5 - 1,5 mm ² 20 - 16	single contact	100	VN 02 016 0002 (1)	VN 02 016 0002 (2)	
			12 + 3 + PE	1		contacts on reel	100	ZN 02 016 0002 (1)	ZN 02 016 0002 (2)	
			12 + PE	2		right	2000	HN 02 016 0002 (1)	HN 02 016 0002 (2)	
			14 + PE	2		left	2000	TN 02 016 0002 (1)	TN 02 016 0002 (2)	
C 16-3	1,6	2,5 - 3,5	8 + PE	1	1,5 - 2,5 mm ² 16 - 14	single contact	100	VN 02 016 0005 (1)	VN 02 016 0005 (2)	
			12 + 3 + PE	1		contacts on reel	200	ZN 02 016 0005 (1)	ZN 02 016 0005 (2)	
			12 + PE	2		right	2000	HN 02 016 0005 (1)	HN 02 016 0005 (2)	
			14 + PE	2		left	2000	TN 02 016 0005 (1)	TN 02 016 0005 (2)	
C 16-3	2,5	1,8 - 2,8	14 + PE	1	0,5 - 1,5 mm ² 20 - 16	single contact	100	VN 02 025 0001 (101)	VN 02 025 0001 (102)	
			12 + PE	2		contacts on reel	100	ZN 02 025 0001 (1)	ZN 02 025 0001 (2)	
						right	2000	HN 02 025 0001 (1)	HN 02 025 0001 (2)	
						left	2000	TN 02 025 0001 (1)	TN 02 025 0001 (2)	
	2,5 - 3,5	1,8 - 2,8	1,8 - 2,8	14 + PE	1	1,5 - 2,5 mm ² 16 - 14	single contact	100	VN 02 025 0010 (101)	VN 02 025 0010 (102)
				12 + PE	2		contacts on reel	200	ZN 02 025 0010 (1)	ZN 02 025 0010 (2)
							right	2000	HN 02 025 0010 (1)	HN 02 025 0010 (2)
							left	2000	TN 02 025 0010 (1)	TN 02 025 0010 (2)

Single contact in plastic bag; stamped contact on reel – HN = feeding right side / TN = feeding left side

Part No. system for crimp contacts

VN 01 016 0001 (1)
1) 2) 3) 4) 5)

- 1) supplied as: VN = single contact 100 pcs.

 ZN = contacts on reel 100 resp. 200 pcs.

 HN = contacts on reel with 2000 contacts (contact feeding right hand side)

 TN = contacts on reel with 2000 contacts (contact feeding left hand side)
- 2) Type of contact: 01 = male contact
 02 = female contact
- 3) Contact Ø: e.g. 016 = 1,6 mm
- 4) Connection and wire gauge, e.g. 0052: 0,09 - 0,25 mm²
 0046: 0,35 - 0,5 mm²
 0047: 0,75 - 1,0 mm²
- 5) Plating: (1) = silver plated
 (2) = gold plated
 (4) = gold plated for high performance

Termination methods

• **Screw connection**

Screw clamps are designed acc. to EN 60999-1 / VDE 609-1.

Chart 1 below shows the screw size depending on wire size and the required clamping and testing torque..

Chart 1

Wire size (mm ²)	max. 4
Screw size	M 3
Test torque (Ncm)	50

Diagram 1 below shows the range of tensile strength for a screw connection with a clamp screw M3, fastened with a torque of 50 Ncm, depending on the wire size.

Diagram 1

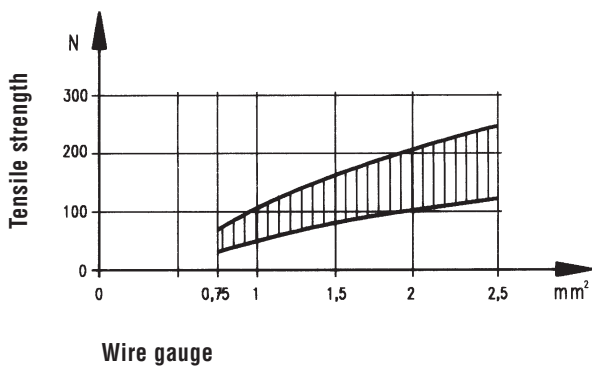

This comparison chart allows a cross reference between American Wire Gauge (AWG) and metric wire sizes (mm²).

Chart 2

AWG	Wire composition	Wire diameter	Wire size
30	1 x 0,25	0,25 mm	0,05 mm ²
	7 x 0,10	0,36 mm	0,06 mm ²
28	1 x 0,32	0,32 mm	0,08 mm ²
	7 x 0,13	0,38 mm	0,09 mm ²
26	1 x 0,40	0,40 mm	0,13 mm ²
	7 x 0,16	0,48 mm	0,14 mm ²
	19 x 0,10	0,51 mm	0,15 mm ²
24	1 x 0,51	0,51 mm	0,21 mm ²
	7 x 0,20	0,61 mm	0,23 mm ²
	19 x 0,13	0,64 mm	0,24 mm ²
22	1 x 0,64	0,64 mm	0,33 mm ²
	7 x 0,25	0,76 mm	0,36 mm ²
	19 x 0,16	0,81 mm	0,38 mm ²
20	1 x 0,81	0,81 mm	0,52 mm ²
	7 x 0,32	0,97 mm	0,56 mm ²
	19 x 0,20	1,02 mm	0,62 mm ²
18	1 x 1,02	1,02 mm	0,79 mm ²
	19 x 0,25	1,27 mm	0,96 mm ²
16	19 x 0,29	1,44 mm	1,23 mm ²
14	19 x 0,36	1,80 mm	1,95 mm ²
12	19 x 0,46	2,29 mm	3,09 mm ²
10	37 x 0,40	3,10 mm	4,60 mm ²
8	133 x 0,29	4,0 mm	8,80 mm ²
6	133 x 0,36	5,5 mm	13,5 mm ²

It has to be noted that wires of the same AWG number but with different composition have slightly different mm².

Chart 3

Composition and Dimensions of Copper Wires

Wire Size	Wire Composition	Wire diameter
0,09 mm ²	12 x 0,10	0,48 mm
0,14 mm ²	18 x 0,10	0,50 mm
0,25 mm ²	14 x 0,15	0,70 mm
0,34 mm ²	7 x 0,25	0,78 mm
0,5 mm ²	16 x 0,20	1,0 mm
0,75 mm ²	24 x 0,20	1,2 mm
1,0 mm ²	32 x 0,20	1,4 mm
1,5 mm ²	30 x 0,25	1,6 mm
2,5 mm ²	35 x 0,30	2,2 mm
4,0 mm ²	56 x 0,30	2,8 mm
6,0 mm ²	19 x 0,64	3,4 mm
10 mm ²	19 x 0,80	4,3 mm

• **Crimp connection**

A crimp connection is a non-detachable electrical connection between a wire and a crimp contact produced with the crimp technology. Precise crimping dies which are matched to the crimp barrel and the wire size and a defined deformation result in a reliable electrical connection.

There are open crimp barrels (stamped contacts) and closed crimp barrels (turned contacts).

The main advantages of crimp connections are:

- Efficient termination of contacts.
- Reproducible termination achieve consistent electrical and mechanical results

The requirements for crimp connections are defined in DIN EN 60352-2, IEC 60352-2.

An important point of the quality of a crimp connection is the achieved tensile strength of the termination.

Easily measured, the tensile strength is a practicable means for quality control purposes.

Diagram 2 below shows the required minimum tensile strength for open and closed barrels depending on the wire size.

Assembly instructions

For crimp contacts use the released crimp tool.

The insertion and extraction of crimp contacts shall only be approved with the corresponding insertion / extraction tool.

A detailed description of the crimp technology can be found in our crimp tooling catalogues.

Crimp contacts are in this catalogues on page 21 and 22.

Diagram 2

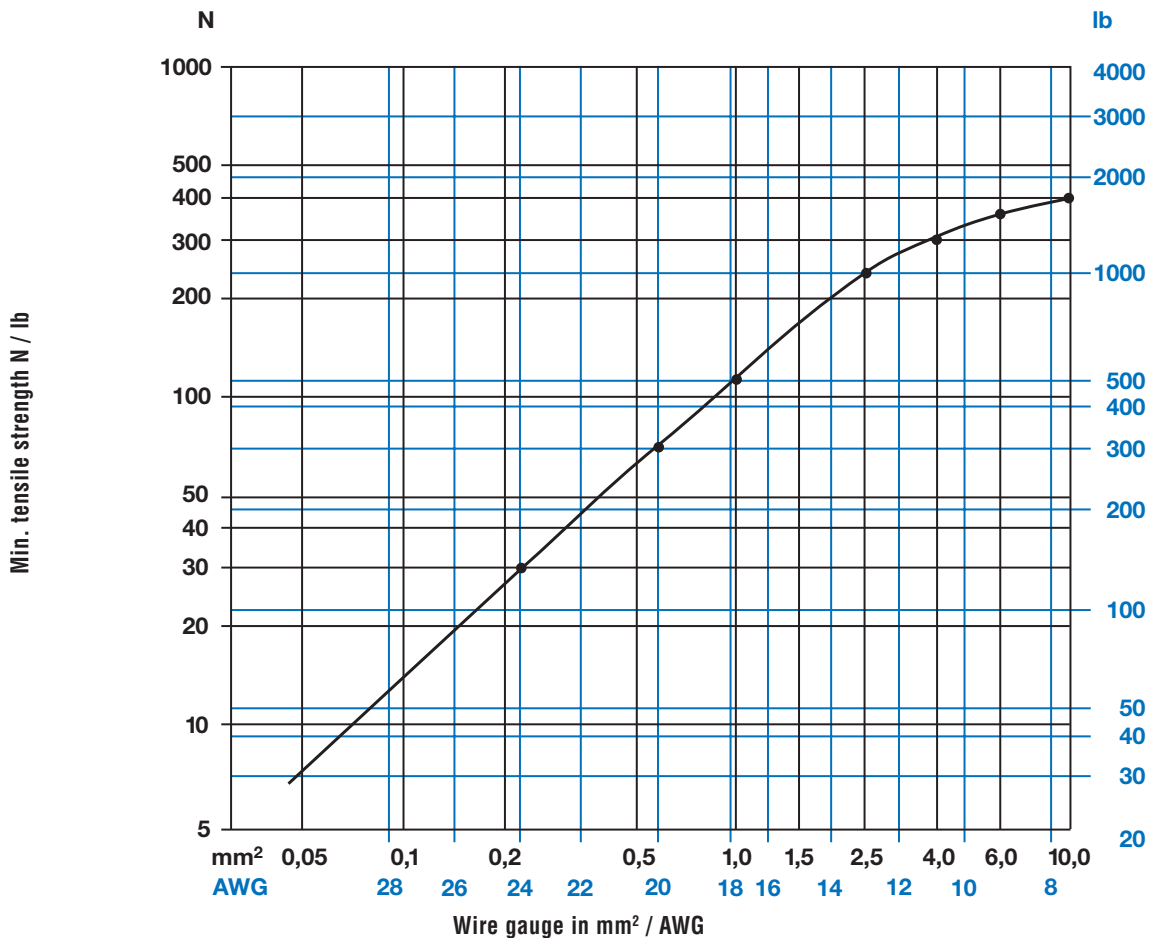

Degree of protection

Electrical devices to which connectors belong to have to be protected for safety reasons from outside influences like dust, foreign objects, direct contact, moisture and water. This protection is provided on industrial connectors by its housings with their latching devices and sealed cable entries. The degree of protection can be selected depending on the type of intended use. The standard IEC 60529 and/or DIN EN 60529 has specified the degree of protection and divided into several classes.

The degree of protection is indicated in the following way:

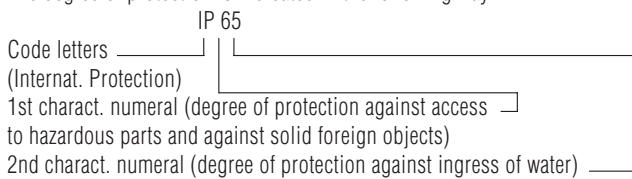

The following charts 4 and 5 give an overview about all protection degrees.

Chart 4

1st charact. numeral	Brief description	Definition
0	Non-protected	–
1	Protected against access to hazardous parts with the back of a hand. Protected against solid foreign objects of $\geq 50\text{mm } \varnothing$.	The probe, sphere of $50\text{mm } \varnothing$, shall not fully penetrate and shall have adequate clearance from hazardous parts.
2	Protected against access to hazardous parts with a finger. Protected against solid foreign objects of $\geq 12,5\text{mm } \varnothing$.	The jointed test finger of $12\text{mm } \varnothing$, 80mm length, shall have adequate clearance from hazardous parts. The probe, sphere of $12,5\text{mm } \varnothing$, shall not fully penetrate.
3	Protected against access to hazardous parts with a tool. Protected against solid foreign objects of $\geq 2,5\text{mm } \varnothing$.	The probe of $2,5\text{mm } \varnothing$ shall not penetrate at all.
4	Protected against access to hazardous parts with a wire. Protected against solid foreign objects of $\geq 1\text{mm } \varnothing$.	The probe of $1\text{mm } \varnothing$ shall not penetrate at all.
5	Protected against access to hazardous parts with a wire. Dust-protected.	The probe of $1\text{mm } \varnothing$ shall not penetrate. Intrusion of dust is not totally prevented, but dust shall not penetrate in a quantity to interfere with satisfactory operation of the device or to impair safety.
6	Protected against access to hazardous parts with a wire. Dust-tight.	The probe of $1\text{mm } \varnothing$ shall not penetrate. No intrusion of dust.

Chart 5

2nd charact. numeral	Brief description	Definition
0	Non-protected	–
1	Protected against vertically falling water drops	Vertically falling drops shall have no harmful effects.
2	Protected against vertically falling water drops when enclosure tilted up to 15°	Vertically falling drops shall have no harmful effects when the enclosure is tilted at any angle up to 15° on either side of the vertical.
3	Protected against spraying water	Water sprayed at an angle up to 60° on either side of the vertical shall have no harmful effects.
4	Protected against splashing water	Water splashed against the enclosure from any direction shall have no harmful effects.
5	Protected against water jets	Water projected in jets against the enclosure from any direction shall have no harmful effects.
6	Protected against powerful water jets	Water projected in powerful jets against the enclosure from any direction shall have no harmful effects.
7	Protected against the effects of temporary immersion in water	Intrusion of water in quantities causing harmful effects shall not be possible when the enclosure is temporarily immersed in water for 30 min. in 1m depth.
8	Protected against the effects of continuous immersion in water	Intrusion of water in quantities causing harmful effects shall not be possible when the enclosure is continuously immersed in water under conditions which shall be agreed between manufacturer and user but which are more severe than for numeral 7.
9 K ¹⁾	Protected against water during high pressure/steam jet cleaning	Water projected in powerful jets with high pressure against the enclosure from any direction shall have no harmful effects.

1) Remark: Numeral acc. to DIN 40050 part 9, vehicles IP code

C16-3

Remarks
Safety classification



1. General Remarks

These connectors are designed and produced in conformity with the low voltage directive (73/23/EWG) respectively Gerätesicherheitsgesetz (German law) and are especially in according with the standards DIN EN 61984 / IEC 61984 (VDE 0627); IEC 60664-1 (VSE 0110-1) and IEC 60529. The connectors may be used only within the technical ratings. These connectors with / without breaking capacity are designed and produced according to DIN EN 61984/VDE0627. All technical data refers to mated connectors under live conditions. The safety of the connector system depends on the correct selection of products, proper assembly of the connector device, and a precise fit of the connectors.

2. Application Remarks

Connectors with / without breaking capacity must be used according to specified technical ratings. The technical data represents the initial value of mated parts under predetermined conditions and length of time. These values could change with different test parameters or product requirements. The 16-3 Series connectors are used in a wide variety of industries and equipment. Some of these include industrial machines and controls, data processing, instrumentation and test equipment, medical devices, telecommunication's network and equipment, plus outdoor and marine applications. All rated data for the connectors listed in this catalogues are based on over-voltage category III ¹⁾ and pollution degree 3 ²⁾ for electronic applications.

Connectors were completely mated according to their respective safety locking mechanism. Selection and testing of connectors with / without breaking capacity to meet specific product or industrial requirements such as rated voltage and the related clearances and creepage distances are the responsibility of the user.

3. Assembling Remarks

Protection against electrical shock of the termination of the connectors shall be secured by correct mounting. Connectors of the same or different series being mounted side by side may be protected against incorrect mating by the use of coding options. Care must be taken to ensure the parts are correctly mated and screws are tightened with the proper torque.

4. Termination Remarks

Cable connectors are effectively secured when using the internal cable clamp. When the connector contains a simple gland bushing for retention without clamping ring the cable should have a strain relief close behind the connector. All cable properties or specifications must be compatible with the connector design and materials. Designated wire conductors must be terminated to the correct poles in the connector. Crimp contacts must be fully inserted into the plastic housing and retention assured with a slight tug on the wire. Wire should be stripped correctly according to printed specifications to insure no electrical contact can be made between the conductors. There should be no nicked or cut strains during the stripping action.

5. Safety Classification acc. to DIN EN 61984 / VDE 0627 / IEC 61984

Style	enclosed mated	enclosed unmated	protective earthing contact	finger safety mated	finger safety unmated	hand back safety mated	connector with breaking capacity	rewirable	Cable clamp	
									with	without
Male cable connector	X	X	X	X		X	X	X	X	X
Female cable connector	X		X	X	X	X	X	X	X	X
Male receptacle screw / crimp	X ³⁾	X	X	X ³⁾		X	X	X		X
Female receptacle screw / crimp	X ³⁾		X	X ³⁾	X ³⁾	X	X	X		X

- ¹⁾ Overvoltage category III: Equipment intended for the use in installations or parts of it in which lightning overvoltages do not need to be considered, however switching overvoltages generated by the equipment, and for cases where the reliability and the availability of the equipment or its dependent circuits are subject to special requirements. Examples are protecting means, switches and sockets.
- ²⁾ Pollution degree 3: Conductive pollution occurs or dry non-conductive pollution occurs which becomes conductive due to condensation which is to be expected.
- ³⁾ Protection against electrical shock on the termination side has to be secured by proper mounting.

Summary of Part Numbers

Part No.	Page	Part No.	Page	Part No.	Page	Part No.	Page
C016 00U000 001 1	14	C016 10D015 801 3	19	C016 10G008 000 5	20	C016 10I008 002 1	12
C016 00U000 001 2	17	C016 10D017 002 1	13	C016 10G012 000 2	15	C016 10I008 003 1	12
C016 00U000 011 2	17	C016 10D017 003 1	13	C016 10G014 000 1	13	C016 10I012 003 2	15
C016 00U000 021 1	14	C016 10D017 012 5	19	C016 10G014 000 2	15	C016 10I012 004 2	15
C016 00V000 001 1	14	C016 10D017 013 5	19	C016 10G014 000 5	20	C016 10I012 005 2	15
C016 00V000 001 2	17	C016 10D017 801 3	19	C016 10G015 000 1	13	C016 10I014 002 1	12
C016 00V000 011 2	17	C016 10D019 003 2	16	C016 10G015 000 5	20	C016 10I014 003 1	12
C016 00V000 021 1	14	C016 10D019 004 2	16	C016 10G017 000 1	13	C016 10I014 003 2	15
C016 10C008 000 1	14	C016 10E008 002 1	13	C016 10G017 000 5	20	C016 10I014 004 2	15
C016 10C008 000 5	20	C016 10E008 003 1	13	C016 10G019 000 2	15	C016 10I014 005 2	15
C016 10C012 000 2	16	C016 10E012 003 2	16	C016 10H008 002 1	12	C016 10I015 002 1	12
C016 10C014 000 1	14	C016 10E012 004 2	16	C016 10H008 003 1	12	C016 10I015 003 1	12
C016 10C014 000 2	16	C016 10E012 005 2	16	C016 10H008 012 5	19	C016 10I017 002 1	12
C016 10C014 000 5	20	C016 10E014 002 1	13	C016 10H008 013 5	19	C016 10I017 003 1	12
C016 10C015 000 1	14	C016 10E014 003 1	13	C016 10H008 801 3	19	C016 10I019 003 2	15
C016 10C015 000 5	20	C016 10E014 003 2	16	C016 10H012 003 2	15	C016 10I019 004 2	15
C016 10C017 000 1	14	C016 10E014 004 2	16	C016 10H012 004 2	15	C016 10I019 005 2	15
C016 10C017 000 5	20	C016 10E014 005 2	16	C016 10H014 002 1	12	C016 10K008 002 1	12
C016 10C019 000 2	16	C016 10E015 002 1	13	C016 10H014 003 1	12	C016 10K008 003 1	12
C016 10D008 002 1	13	C016 10E015 003 1	13	C016 10H014 003 2	15	C016 10K012 004 2	15
C016 10D008 003 1	13	C016 10E017 002 1	13	C016 10H014 004 2	15	C016 10K014 002 1	12
C016 10D008 012 5	19	C016 10E017 003 1	13	C016 10H014 005 2	15	C016 10K014 003 1	12
C016 10D008 013 5	19	C016 10E019 003 2	16	C016 10H014 012 5	19	C016 10K014 004 2	15
C016 10D008 801 3	19	C016 10E019 004 2	16	C016 10H014 013 5	19	C016 10K015 002 1	12
C016 10D012 003 2	16	C016 10E019 005 2	16	C016 10H014 801 3	19	C016 10K015 003 1	12
C016 10D012 004 2	16	C016 10F008 002 1	13	C016 10H015 002 1	12	C016 10K017 002 1	12
C016 10D014 002 1	13	C016 10F008 003 1	13	C016 10H015 003 1	12	C016 10K017 003 1	12
C016 10D014 003 1	13	C016 10F012 004 2	16	C016 10H015 012 5	19	C016 10K019 004 2	15
C016 10D014 003 2	16	C016 10F014 002 1	13	C016 10H015 013 5	19	C016 10N008 000 5	20
C016 10D014 004 2	16	C016 10F014 003 1	13	C016 10H015 801 3	19	C016 10N008 006 1	13
C016 10D014 012 5	19	C016 10F014 004 2	16	C016 10H017 002 1	12	C016 10N014 000 5	20
C016 10D014 013 5	19	C016 10F015 002 1	13	C016 10H017 003 1	12	C016 10N014 006 1	13
C016 10D014 801 3	19	C016 10F015 003 1	13	C016 10H017 012 5	19	C016 10N015 000 5	20
C016 10D015 002 1	13	C016 10F017 002 1	13	C016 10H017 013 5	19	C016 10N015 006 1	13
C016 10D015 003 1	13	C016 10F017 003 1	13	C016 10H017 801 3	19	C016 10N017 000 5	20
C016 10D015 012 5	19	C016 10F019 004 2	16	C016 10H019 003 2	15	C016 10N017 006 1	13
C016 10D015 013 5	19	C016 10G008 000 1	13	C016 10H019 004 2	15	C016 20C005 100 2	16

Summary of Part Numbers

Part No.	Page	Part No.	Page	Part No.	Page	Part No.	Page
C016 20D005 103 2	16	HN 02 016 0002 (1)	22	TN 02 016 0005 (2)	22	ZN 01 015 0046 (1)	21
C016 20D005 104 2	16	HN 02 016 0002 (2)	22	TN 02 025 0001 (1)	22	ZN 01 015 0046 (2)	21
C016 20E005 103 2	16	HN 02 016 0003 (1)	22	TN 02 025 0001 (2)	22	ZN 01 015 0047 (1)	21
C016 20E005 104 2	16	HN 02 016 0003 (2)	22	TN 02 025 0010 (1)	22	ZN 01 015 0047 (2)	21
C016 20E005 105 2	16	HN 02 016 0005 (1)	22	TN 02 025 0010 (2)	22	ZN 01 015 0052 (1)	21
C016 20F005 104 2	16	HN 02 016 0005 (2)	22	VN 01 015 0046 (1)	21	ZN 01 015 0052 (2)	21
C016 20G005 100 2	15	HN 02 025 0001 (1)	22	VN 01 015 0046 (2)	21	ZN 01 016 0002 (1)	21
C016 20H005 103 2	15	HN 02 025 0001 (2)	22	VN 01 015 0047 (1)	21	ZN 01 016 0002 (2)	21
C016 20H005 104 2	15	HN 02 025 0010 (1)	22	VN 01 015 0047 (2)	21	ZN 01 016 0003 (1)	21
C016 20I005 103 2	15	HN 02 025 0010 (2)	22	VN 01 015 0052 (1)	21	ZN 01 016 0003 (2)	21
C016 20I005 104 2	15	TN 01 015 0046 (1)	21	VN 01 015 0052 (2)	21	ZN 01 016 0005 (1)	21
C016 20I005 105 2	15	TN 01 015 0046 (2)	21	VN 01 016 0002 (1)	21	ZN 01 016 0005 (2)	21
C016 20K005 104 2	15	TN 01 015 0047 (1)	21	VN 01 016 0002 (2)	21	ZN 01 025 0001 (1)	21
FH 0000-016	14	TN 01 015 0047 (2)	21	VN 01 016 0003 (1)	21	ZN 01 025 0001 (2)	21
FH 0002-016	17	TN 01 015 0052 (1)	21	VN 01 016 0003 (2)	21	ZN 01 025 0010 (1)	21
HN 01 015 0046 (1)	21	TN 01 015 0052 (2)	21	VN 01 016 0005 (1)	21	ZN 01 025 0010 (2)	21
HN 01 015 0046 (2)	21	TN 01 016 0002 (1)	21	VN 01 016 0005 (2)	21	ZN 02 015 0046 (1)	22
HN 01 015 0047 (1)	21	TN 01 016 0002 (2)	21	VN 01 025 0001 (101)	21	ZN 02 015 0046 (2)	22
HN 01 015 0047 (2)	21	TN 01 016 0003 (1)	21	VN 01 025 0001 (102)	21	ZN 02 015 0047 (1)	22
HN 01 015 0052 (1)	21	TN 01 016 0003 (2)	21	VN 01 025 0010 (101)	21	ZN 02 015 0047 (2)	22
HN 01 015 0052 (2)	21	TN 01 016 0005 (1)	21	VN 01 025 0010 (102)	21	ZN 02 015 0052 (1)	22
HN 01 016 0002 (1)	21	TN 01 016 0005 (2)	21	VN 02 015 0046 (1)	22	ZN 02 015 0052 (2)	22
HN 01 016 0002 (2)	21	TN 01 025 0001 (1)	21	VN 02 015 0046 (2)	22	ZN 02 016 0002 (1)	22
HN 01 016 0003 (1)	21	TN 01 025 0001 (2)	21	VN 02 015 0047 (1)	22	ZN 02 016 0002 (2)	22
HN 01 016 0003 (2)	21	TN 01 025 0010 (1)	21	VN 02 015 0047 (2)	22	ZN 02 016 0003 (1)	22
HN 01 016 0005 (1)	21	TN 01 025 0010 (2)	21	VN 02 015 0052 (1)	22	ZN 02 016 0003 (2)	22
HN 01 016 0005 (2)	21	TN 02 015 0046 (1)	22	VN 02 015 0052 (2)	22	ZN 02 016 0005 (1)	22
HN 01 025 0001 (1)	21	TN 02 015 0046 (2)	22	VN 02 016 0002 (1)	22	ZN 02 016 0005 (2)	22
HN 01 025 0001 (2)	21	TN 02 015 0047 (1)	22	VN 02 016 0002 (2)	22	ZN 02 025 0001 (1)	22
HN 01 025 0010 (1)	21	TN 02 015 0047 (2)	22	VN 02 016 0003 (1)	22	ZN 02 025 0001 (2)	22
HN 01 025 0010 (2)	21	TN 02 015 0052 (1)	22	VN 02 016 0003 (2)	22	ZN 02 025 0010 (1)	22
HN 02 015 0046 (1)	22	TN 02 015 0052 (2)	22	VN 02 016 0005 (1)	22	ZN 02 025 0010 (2)	22
HN 02 015 0046 (2)	22	TN 02 016 0002 (1)	22	VN 02 016 0005 (2)	22		
HN 02 015 0047 (1)	22	TN 02 016 0002 (2)	22	VN 02 025 0001 (101)	22		
HN 02 015 0047 (2)	22	TN 02 016 0003 (1)	22	VN 02 025 0001 (102)	22		
HN 02 015 0052 (1)	22	TN 02 016 0003 (2)	22	VN 02 025 0010 (101)	22		
HN 02 015 0052 (2)	22	TN 02 016 0005 (1)	22	VN 02 025 0010 (102)	22		

International

Argentina

Amphenol Argentina
Av. Callao 930
2nd Floor Office B "Plaza"
C1023 AAP Buenos Aires
Phone +54 / 11 / 48156886
Fax +54 / 11 / 48145779

Australia

Amphenol Australia Ltd.
2 Fiveways Blvd
Keysborough
Victoria 3173
Phone +61 / 3 / 8796 / 8888
Fax +61 / 3 / 8796 / 8801

Belgium

Amphenol-Tuchel Belgium
Brusselbaan 524b
B1600 Sint-Pieters-Leeuw
Phone +32 / 2377 / 2549
Fax +32 / 2377 / 5303

Brasilia

Amphenol do Brasil Ltda.
Rua Diogo Moreira 132, 20th Floor
CEP 05423-010 Sao Paulo SP
Phone +55 / 11 / 3815.1003
Fax +55 / 11 / 3815.1629

China

Amphenol-Tuchel Electronics GmbH
China Branch
210-1 Taishan Road
Changzhou 213022
Phone +86 / 0519 / 5110301
Fax +86 / 0519 / 5110299

France

Amphenol-Tuchel France
Bât. Le Newton C
7 Mail B. Thimonnier
77185 Lognes
Phone +33 / 164627676
Fax +33 / 164627677

Germany

Amphenol-Tuchel Electronics GmbH
August-Hauesser-Str. 10
74080 Heilbronn
Phone +49 / 7131 / 929-0
Fax +49 / 7131 / 929-486

Great Britain

Amphenol-Tuchel Great Britain
14 Plover Close
Kempshott, Basingstoke
Hants, RG22 5PQ
Phone +44 / 1256 / 330749
Fax +44 / 1256 / 330749

Hong Kong

Amphenol East Asia Limited
Units 2201-02, Railway Plaza
39 Chatham Road South
Tsimshatsui, Kowloon
Phone +852 / 2699 / 2663
Fax +852 / 2688 / 0974

India

Amphetrnix Limited
Plot No. 105 Bhosari Industrial Area
Pune - 411 026
Phone +91 / 20 / 27121418
Fax +91 / 20 / 27120581

Italy

Amphenol-Tuchel Italy
Via Barbaiana n. 5
I-20020 Lainate (MI)
Phone +39 / 2 / 932 541
Fax +39 / 2 / 932 54444

Japan

Amphenol Japan, K.K.
2-3-27, Kudan Minami
Chiyoda-Ku
Tokyo 102
Phone +81 / 3 / 3263 / 5611
Fax +81 / 3 / 5276 / 7059

Korea

Amphenol DaeShin Limited
#802 Joong-Dong 1131-5
Wonmi-Ku
Bucheon-City
Kyunggi-Do
Korea 420-020
Phone +82 / 2 / 785 / 1588
Fax +82 / 2 / 589 / 1514

Mexico

Amphenol Mexico
Prolongacion Reforma 61 - 6 B2
Col. Paseo de las Lomas
C.P. 01330 Mexico D.F.
Phone +52 / 55 / 5258.9984
Fax +52 / 55 / 5081.6890

Singapore

Amphenol East Asia Limited
Asia Pacific Sales Operation
Singapore Branch
300 Beach Road
#25-07 The Concourse
Singapore 199555
Phone +27 / 11 / 305-9574
Fax +27 / 11 / 305-9576

South Africa

Amphenol International Ltd
Chislehurst
30 Impala Road
Chislehurst
Sandton, 2146
Phone +27 / 11 / 7839517
Fax +27 / 11 / 7839519

Spain

Amphenol-Tuchel Spain
Ctra Sabadell a Mollet,
km 4.5 Nave 5
08130 Santa Perpetua de
Mogoda (Barcelona)
Phone +34 / 93 / 574.41.34
Fax +34 / 93 / 574.10.09

Sweden

Amphenol-Tuchel Scandinavia
P.O. Box 20
SE 195 42 Märsta
Phone +46 / 8 591 / 175 76
Fax +46 / 8 591 / 175 76

Taiwan

Amphenol East Asia Ltd.
Taiwan Branch (H.K.)
116 Zhong Shan Road
Lane 956 Taoyuan City
Taiwan R.O.C. 330
Phone +886 / 3 / 370 / 7855
Fax +886 / 3 / 360 / 7259

Turkey

Amphenol Turkiye
Ayazaga Mah. Meydan Sk. No. 28
Beybi Giz Plaza, Kat. 26
34396 Maslak/Istanbul
Phone +90 / 0212 / 3352501
Fax +90 / 0212 / 3352500

USA

Amphenol-Tuchel Electronics
6900 Haggerty Road
Suite 200
Canton, Michigan 48187
Phone +1 / 734 / 4516400
Fax +1 / 734 / 451 7197

Amphenol Corporation
Corporate Headquarters
358 Hall Avenue
Wallingford, CT 06492
Phone +1 / 800 / 380 8052
Phone +1 / 203 / 265 / 8900
Fax +1 / 203 / 265 / 8628

Your engineering sales representative:

Amphenol

Amphenol-Tuchel Electronics GmbH

August-Hauesser-Str. 10 · D-74080 Heilbronn · Germany · Phone +49 (0) 71 31/9 29-0 · Fax +49 (0) 71 31/9 29-486 · www.amphenol.info