

REVISIONS			
REV	ECN, ERN NO.	DATE	APPRD.
J	PRODUCT DRAWING (EAR 12782)	JUN27/05	K.L.

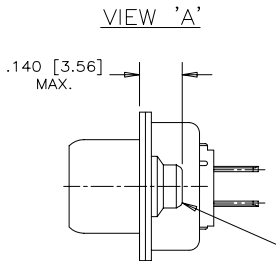
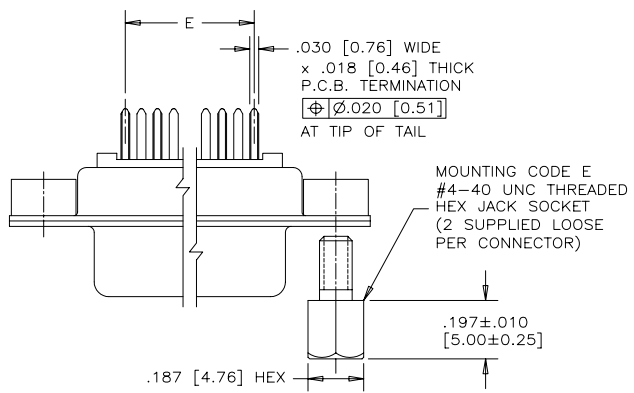

ORDERING CODE: FCC17 - E09PE - 440G

SERIES _____

SIZE/NUMBER OF CONTACTS
E09, A15, B25, OR C37

CONNECTOR STYLE
P=PIN
S=SOCKET

TERMINATION TYPE
E=VERTICAL MOUNT PCB TAIL

CONTACT FINISH/GOLD THICKNESS
NO DIGIT=STANDARD 15 MICROINCHES
[0.38 MICRONS] GOLD ON MATING AREA
G=50 MICROINCHES [1.27 MICRONS]
GOLD ON MATING AREA

MODIFIER
0=STANDARD

FILTER CAPACITANCE
D=50 pF 5=1000 pF
B=100 pF 7=1200 pF
O=180 pF E=2200 pF
F=330 pF 9=5600 pF
1=470 pF 8=47000 pF
4=820 pF N=NOT FILTERED

REFER TO AMPHENOL CATALOGUE FOR
FILTER PERFORMANCE CHARACTERISTICS

MOUNTING
2=.120[3.05] DIA THROUGH HOLE
3=#4-40 UNC SELF-LOCKING THREAD
4=#4-40 UNC THREAD
5=#4-40 UNC THREADED STANDOFF
6=M3 x 0.5 THREAD
9=STANDOFF WITH BOARDLOCK &
#4-40 THREADED JACK SOCKETS
INSTALLED
A=#4-40 THREADED STANDOFF WITH
BOARDLOCK
E=CODE 4 MOUNTING WITH #4-40 UNC
HEX JACK SOCKET SUPPLIED.
J=M3 x 0.5 THREADED STANDOFF WITH
BOARDLOCK

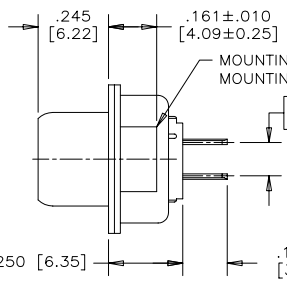
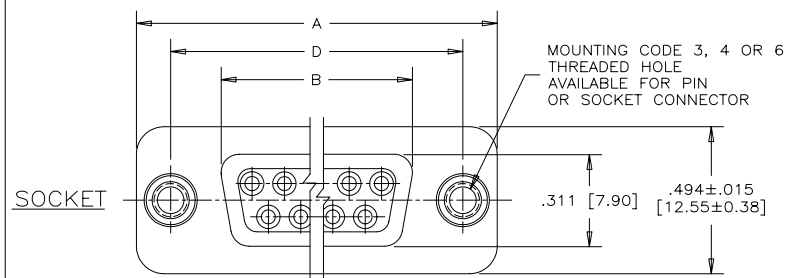

NOTES:

- MATERIALS: - SHELLS - TIN PLATED STEEL
- CONTACTS - PHOSPHOR BRONZE PLATED WITH GOLD OVER NICKEL ON THE MATING AREA AND TIN-LEAD ON THE TERMINALS
- INSULATOR - ENGINEERING THERMOPLASTIC, FLAMMABILITY RATING UL94V-0, BLACK.
- CONTACT RESISTANCE: 15 MILLIOHMS MAXIMUM.
- INSULATION RESISTANCE: 3000 MEGOHMS MINIMUM
- CURRENT RATING: 5 AMPS MAXIMUM
2 AMPS FILTERING MAXIMUM
- OPERATING TEMPERATURE: -40°C TO 85°C.
- TOLERANCE, UNLESS INDICATED OTHERWISE, ±.005 [0.13].

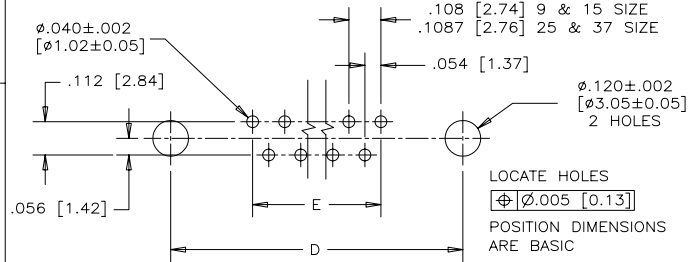
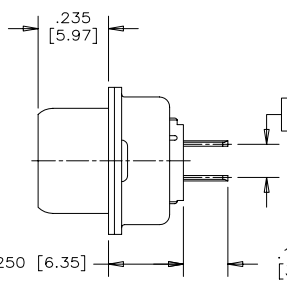
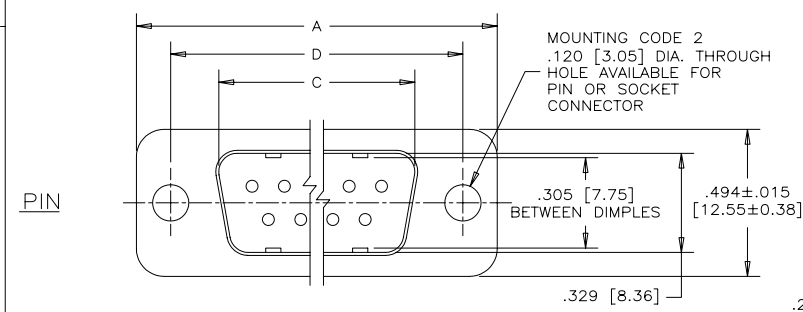

CAPACITANCE SCHEMATIC
TYPICAL FOR EACH LINE

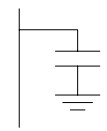

SIZE	STYLE	A±.015 [0.38]	B±.005 [0.13]	C±.005 [0.13]	D±.005 [0.13]	E BSC.
E09	PIN	1.213 [30.81]	-----	.666[16.92]	.984 [24.99]	.432 [10.97]
	SOCKET		.643[16.33]	-----		
A15	PIN	1.541 [39.14]	-----	.994[25.25]	1.312 [33.32]	.756 [19.20]
	SOCKET		.971[24.66]	-----		
B25	PIN	2.088 [53.04]	-----	1.534[38.96]	1.852 [47.04]	1.304 [33.12]
	SOCKET		1.511[38.38]	-----		
C37	PIN	2.729 [69.32]	-----	2.182[55.42]	2.500 [63.50]	1.956 [49.68]
	SOCKET		2.159[54.84]	-----		

DRAWN I.ESSAJEE	DATE 97/12/01
DESIGNED K.LAMBIE	97/11/27
CHECKED	
I. E. APPRD.	
Q. A. APPRD.	
DWG. APPRD.	
ENG. REL. NO.	
REF.	
DIMENSIONS ARE IN INCHES [mm]	CODE ID. NO. 03554

Amphenol Canada Corp.

TITLE FCC17 FILTERED D-SUB,
VERTICAL MOUNT PCB TAIL,
PIN & SOCKET

DWG. DRAWING NO. P-FCC17-XXXXE-XXOX

SCALE 3/1 WT. ----- SURF. ----- SHEET 1 OF 2

SEE SHEET #2 FOR ADDITIONAL MOUNTING OPTION VIEWS

THIS DOCUMENT CONTAINS PROPRIETARY INFORMATION AND SUCH INFORMATION MAY NOT BE DISCLOSED TO OTHERS FOR ANY PURPOSE OR USED FOR MANUFACTURING PURPOSES WITHOUT WRITTEN PERMISSION FROM AMPHENOL CANADA CORP.

REVISIONS			
REV	ECN, ERN NO.	DATE	APPRD.
J	PRODUCT DRAWING (EAR 12782)	JUN27/05	K.L.

ADDITIONAL MOUNTING OPTIONS AVAILABLE
FOR PIN OR SOCKET CONNECTOR

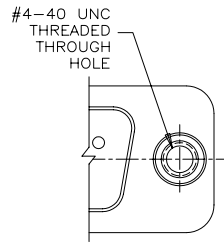

PARTIAL FRONT VIEW

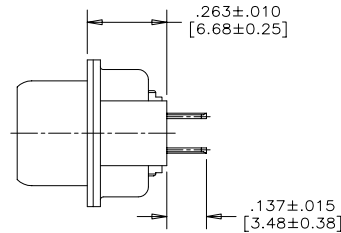

SIDE VIEW

MOUNTING CODE 5

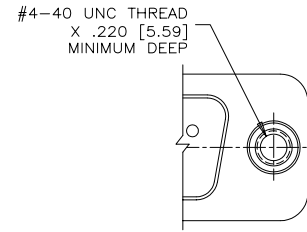

PARTIAL FRONT VIEW

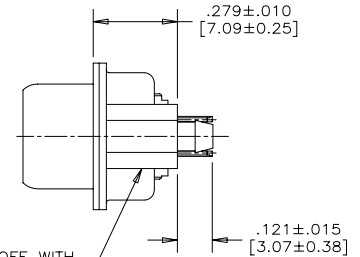

SIDE VIEW

MOUNTING CODE A

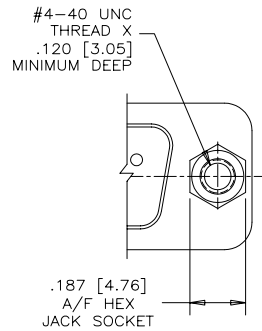

PARTIAL FRONT VIEW

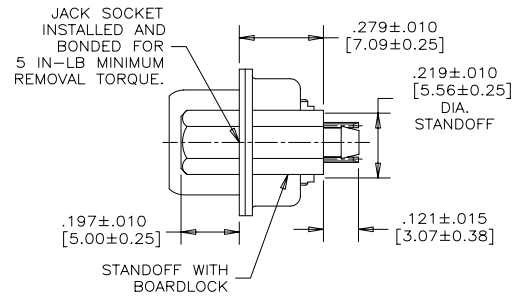

SIDE VIEW

MOUNTING CODE 9

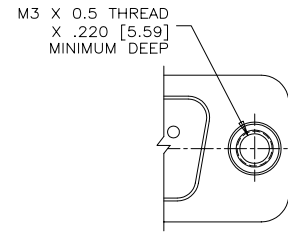

PARTIAL FRONT VIEW

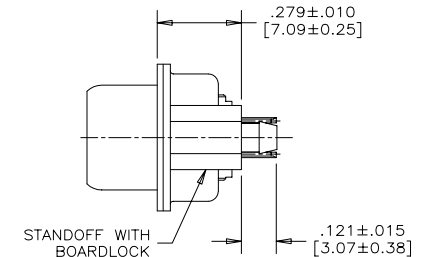

SIDE VIEW

MOUNTING CODE J

DRAWN I.ESSAJEE	DATE 97/12/01
DESIGNED K.LAMBIE	97/11/27
CHECKED	
I. E. APPRD.	
Q. A. APPRD.	
DWG. APPRD.	
ENG. REL. NO.	
REF.	
DIMENSIONS ARE IN INCHES [mm]	CODE ID. NO. 03554

Amphenol Canada Corp.

TITLE FCC17 FILTERED D-SUB,
VERTICAL MOUNT PCB TAIL,
PIN & SOCKET

DWG	DRAWING NO.	REV.
C	P-FCC17-XXXXE-XXOX	J
SCALE 3/1	WT. -----	SURF. -----
SHEET 2 OF 2		

THIS DOCUMENT CONTAINS PROPRIETARY INFORMATION AND SUCH INFORMATION MAY NOT BE DISCLOSED TO OTHERS FOR ANY PURPOSE OR USED FOR MANUFACTURING PURPOSES WITHOUT WRITTEN PERMISSION FROM AMPHENOL CANADA CORP.