

REVISIONS			
SYM	ZONE	ECN, ERN NO.	DATE
C		PRODUCT DRAWING	01/03/16
			APPRD. C.B.

THIS IS A CAD DRAWING. DO NOT MANUALLY REVISE!

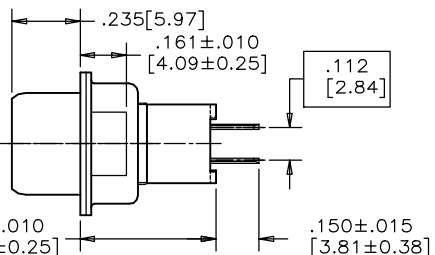
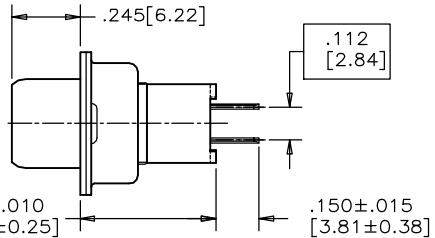
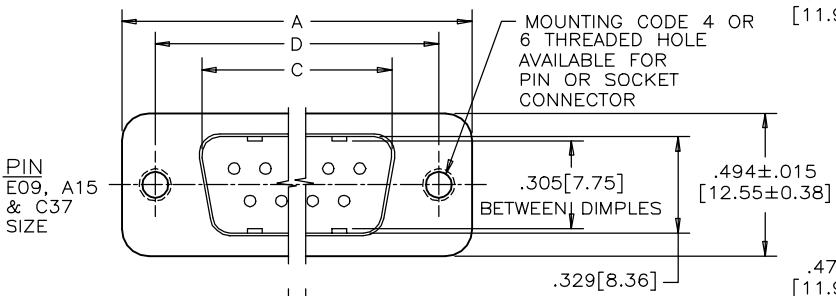
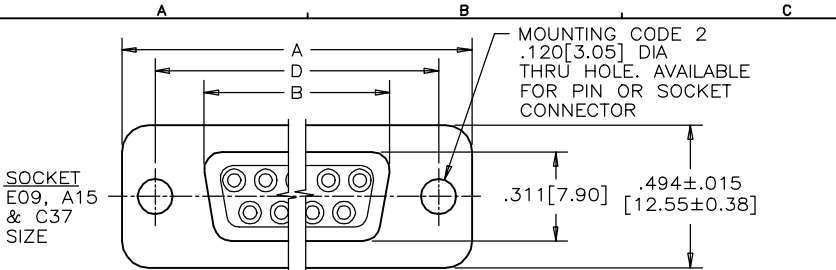

NOTES:

- MATERIALS: - SHELLS - TIN PLATED STEEL
- CONTACTS - PHOSPHOR BRONZE PLATED WITH GOLD OVER NICKEL ON THE MATING AREA AND TIN-LEAD ON THE TERMINALS
- INSULATOR - ENGINEERING THERMOPLASTIC, FLAMMABILITY RATING UL94V-0, BLACK
- CONTACT RESISTANCE: 15 MILLIOHMS MAXIMUM.
- INSULATION RESISTANCE: 3000 MEGOHMS MINIMUM
- CURRENT RATING: 5 AMPS MAXIMUM
2 AMPS FILTERING MAXIMUM
- OPERATING TEMPERATURE: -40°C TO 85°C.
- TOLERANCE, UNLESS INDICATED OTHERWISE, ±.005 [0.13].

ADDITIONAL MOUNTING OPTIONS AVAILABLE FOR PIN OR SOCKET CONNECTOR

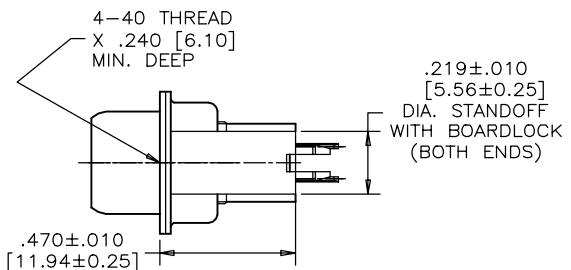
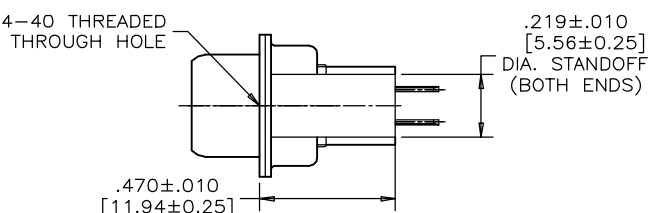
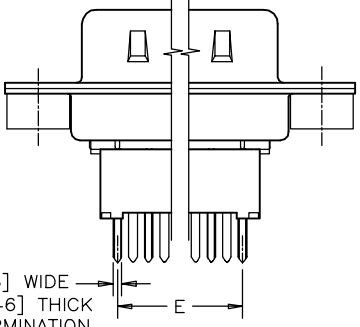

ORDERING CODE: **F C C 1 7 - E 0 9 P N - 2 E 0 G**

SERIES _____

SIZE/NUMBER OF CONTACTS
E09, A15, B25, OR C37

CONNECTOR STYLE
P=PIN
S=SOCKET

TERMINATION TYPE
N=VERTICAL MOUNT PC TAIL,
.470 [11.94] FLANGE TO BOARD

MOUNTING
2=.120 [3.05] DIA THROUGH HOLE
4=#4-40 UNC THREAD
5=#4-40 THREADED STANDOFF
6=M3 x 0.5 THREAD
A=#4-40 THREADED STANDOFF WITH BOARDLOCK

CONTACT FINISH/GOLD THICKNESS
NO DIGIT=STANDARD 15 MICROINCHES [0.38 MICRONS] GOLD
G=50 MICROINCHES [1.27 MICRONS] GOLD

MODIFIER
O=STANDARD

FILTER CAPACITANCE
D=50 pF 5=1000 pF
0=180 pF E=2200 pF
1=470 pF 9=5600 pF
4=820 pF 8=47000 pF

REFER TO AMPHENOL CATALOGUE FOR FILTER PERFORMANCE CHARACTERISTICS

SIZE	STYLE	A±.015 [0.38]	B±.005 [0.13]	C±.005 [0.13]	D±.005 [0.13]	E BSC.
E09	PIN	1.213 [30.81]	-----	.666 [16.92]	.984 [24.99]	.432 [10.97]
	SOCKET		.643 [16.33]	-----		
A15	PIN	1.541 [39.14]	-----	.994 [25.25]	1.312 [33.32]	.756 [19.20]
	SOCKET		.971 [24.66]	-----		
B25	PIN	2.088 [53.04]	-----	1.534 [38.96]	1.852 [47.04]	1.304 [33.12]
	SOCKET		1.511 [38.38]	-----		
C37	PIN	2.729 [69.32]	-----	2.182 [55.42]	2.500 [63.50]	1.956 [49.68]
	SOCKET		2.159 [54.84]	-----		

DRAWN I.ESSAJEE	DATE 98/01/15
DESIGNED	
CHECKED K.LAMBIE	98/01/15
I. E. APPRD. A.GREEN	98/01/19
Q. A. APPRD. A.ARENT	98/01/19
DWG. APPRD.	
ENG. REL. NO.	
REF. EAR C10316	
DIMENSIONS ARE IN INCHES [mm]	CODE ID. NO. 03554

Amphenol Canada Corp.

TITLE FCC17 FILTERED D-SUB, PIN & SOCKET, STRAIGHT P.C.B. TAIL, .470" [11.94] FLANGE TO BOARD

DWG	DRAWING NO.	REV.
C	P-FCC17-XXXXN-XX0X	C
SCALE 3/1	WT. -----	SURF. -----
		SHEET 1 OF 1

THIS DOCUMENT CONTAINS PROPRIETARY INFORMATION AND SUCH INFORMATION MAY NOT BE DISCLOSED TO OTHERS FOR ANY PURPOSE OR USED FOR MANUFACTURING PURPOSES WITHOUT WRITTEN PERMISSION FROM AMPHENOL CANADA CORP.