

REVISIONS				
SYM	ZONE	ECN, ERN NO.	DATE	APPRD.
H		ADD GENERAL TOLERANCE	APR01/13	L.CHAN
J		FIX STANDOFF ISSUE	OCT21/13	L.CHAN
K		UPDATED TOLERANCES	APR03/14	L.CHAN

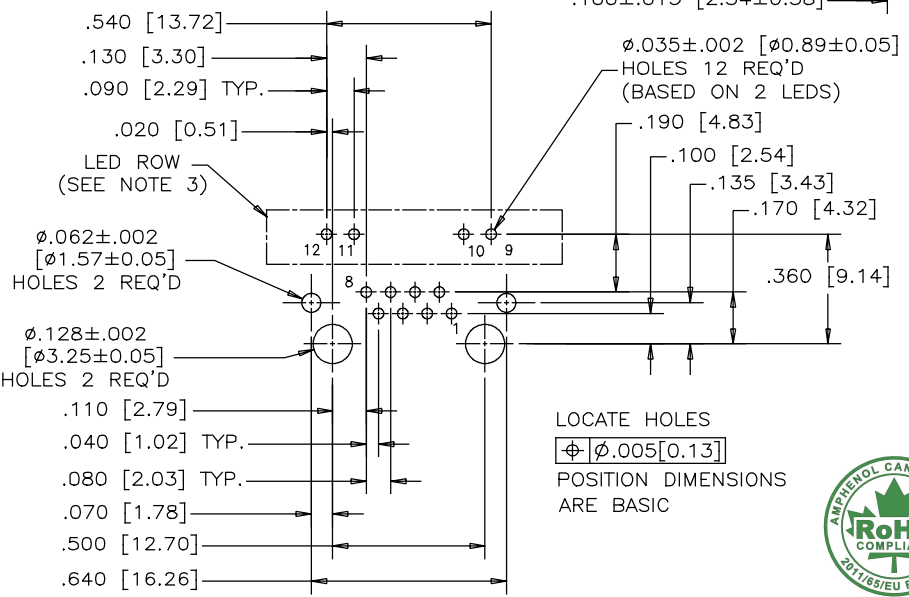

LOCATE HOLES
 $\phi \pm .005 [0.13]$
 POSITION DIMENSIONS
 ARE BASIC

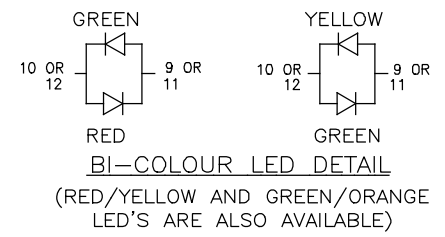
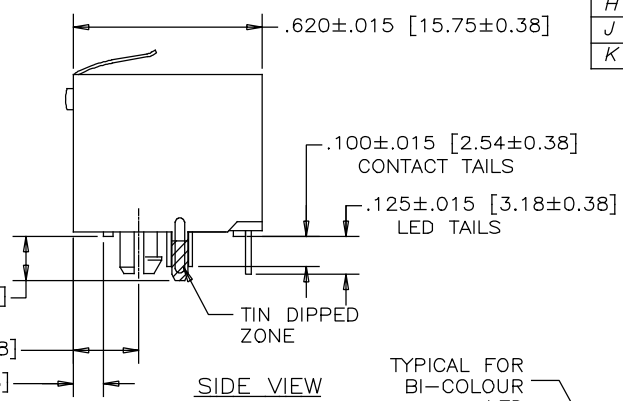
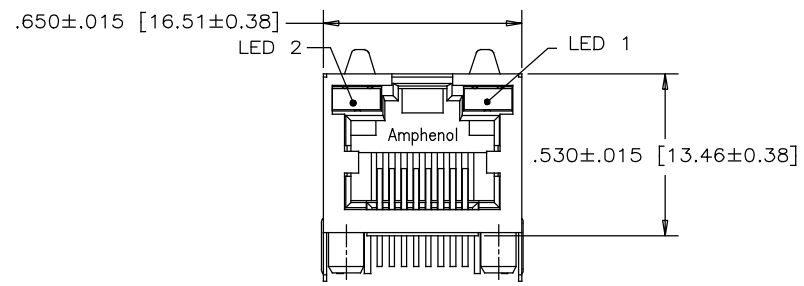
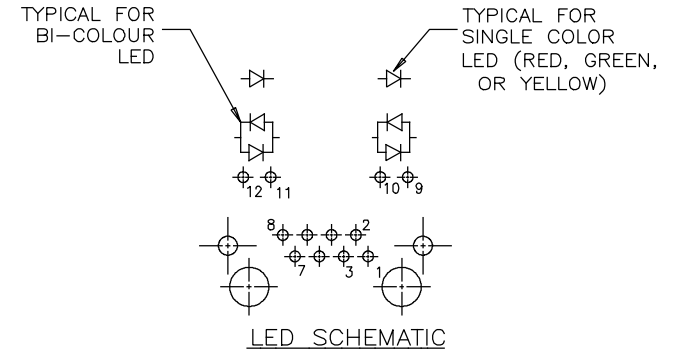

NOTES:

- MATERIALS:**
 PLASTIC HOUSING: HIGH TEMPERATURE THERMOPLASTIC
 FLAMMABILITY RATING UL 94V-0, COLOUR: BLACK

 CONTACTS: PHOSPHOR BRONZE
 PLATING: 50 μ " [1.27 MICRONS]
 MIN. GOLD ON MATING SURFACES.
 50 μ " [1.27 MICRONS]
 MIN. NICKEL UNDERPLATE
 100 μ " [2.54 MICRONS]
 MIN. MATTE TIN ON CONTACT TAILS.

 SHIELD: STAINLESS STEEL WITH TIN DIP ON SOLDER TAIL
- RECOMMENDED SOLDERING TEMPERATURE:**
 WAVE SOLDERING AT 260°C MAXIMUM FOR 5 SEC MAXIMUM.
- P.C.B. HOLE LAYOUT:**
 AMPHENOL PART NUMBER RJHSE-538X P.C.B LAYOUT LED HOLES ARE OPTIONAL.
- PART NUMBER:** RJHSE-538X
 REFER TO LED OPTIONS DRAWING FOR ORDERING CODES

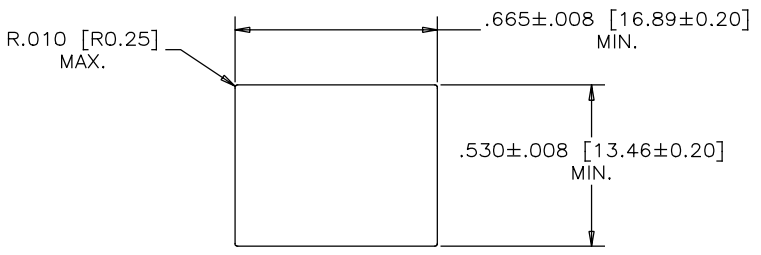

RECOMMENDED PANEL CUTOUT

THIS DOCUMENT CONTAINS PROPRIETARY INFORMATION AND SUCH INFORMATION MAY NOT BE DISCLOSED TO OTHERS FOR ANY PURPOSE OR USED FOR MANUFACTURING PURPOSES WITHOUT WRITTEN PERMISSION FROM AMPHENOL CANADA CORP.

DRAWN PAULW	DATE APR13/06	Amphenol Canada Corp.
DESIGNED		
CHECKED CHIGOW	APR13/06	TITLE
I. E. APPRD.		HIGH SPEED, RJ45, MODULAR JACK, 8 POSITION, 8 CONTACTS, SHIELDED, WITH LEDs - RoHS COMPLIANT
Q. A. APPRD.		DWG. APPRD.
DWG. APPRD.		ENG. REL. NO.
REF.		DWG. DRAWING NO.
DIMENSIONS ARE IN INCHES [mm]	CODE ID. NO. 03554	P-RJHSE-538X
SCALE	WT. -----	SURF. -----
		SHEET 1 OF 1



LED 2 (LEFT)

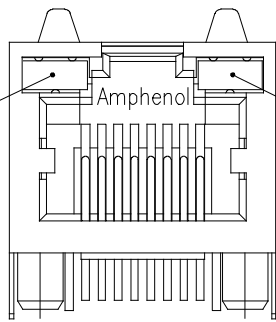

LED 1 (RIGHT)

TYPICAL FOR SINGLE & MULTI-PORT



LED COLOR CODE

EXAMPLE:

PART NUMBER RJHSE-538X

CODE	LED 2 (LEFT)	LED 1 (RIGHT)	CODE	LED 2 (LEFT)	LED 1 (RIGHT)	CODE	LED 2 (LEFT)	LED 1 (RIGHT)
0	BLOCKED	BLOCKED	9	GREEN	BLOCKED	J	BiC RD/GR	YELLOW
1	YELLOW	GREEN	A	BiC GR/YE	BiC GR/YE	K	YELLOW	BiC GR/OR
2	BLOCKED	GREEN	B	BiC RD/GR	BiC RD/GR	L	BiC GR/YE	RED
3	YELLOW	BLOCKED	C	BiC RD/GR	BiC GR/YE	M	RED	YELLOW
4	GREEN	YELLOW	D	GREEN	BiC GR/YE	N	BiC GR/RD	BiC GR/YE
5	GREEN	GREEN	E	YELLOW	BiC GR/YE	P	GREEN	BiC RD/GR
6	YELLOW	YELLOW	F	BiC GR/YE	YELLOW	R	BiC GR/OR	GREEN
7	RED	GREEN	G	BiC GR/OR	BiC GR/OR	T	RED	RED
8	GREEN	RED	H	BiC GR/YE	GREEN	V	BiC RD/GR	GREEN
						W	ADDITIONAL	OPTIONS

EXAMPLE OF ADDITIONAL LED OPTIONS:

PART NUMBER RJHSE-538W-01Y

ADDITIONAL LED COLOR CODE

DENOTES ADDITIONAL LED OPTIONS TO BE USED

CODE	LED 2 (LEFT)	LED 1 (RIGHT)	CODE	LED 2 (LEFT)	LED 1 (RIGHT)	CODE	LED 2 (LEFT)	LED 1 (RIGHT)
0	DO NOT USE		5	BLOCKED	YELLOW	E	BiC GR/YE	BiC GR/RD
1	RED	BLOCKED	6	RED	BiC RD/GR	A	LOWC YE	LOWC YE
2	BiC GR/OR	YELLOW	7	BLOCKED	BiC RD/GR	B	LOWC YE	LOWC GR
3	YELLOW	RED	8	BiC RD/GR	BLOCKED	C	LOWC GR	LOWC YE
4	BLOCKED	RED	9	BiC GR/YE	BLOCKED	D	LOWC GR	LOWC GR
						M	LOWC RD	LOWC YE

REVISIONS				
SYM	ZONE	ECN, ERN NO.	DATE	APPRD.
A		PROPOSAL	SEP21/04	
B		ADD LED CODE N	AUG16/12	L.C
C		UPDATE RoHS STAMP	AUG30/13	L.C

LED SPECIFICATIONS:

FORWARD VOLTAGE: 2.1 VOLTS TYP.
 REVERSE VOLTAGE: 5.0 VOLTS MIN.
 LUMINOUS INTENSITY: 0.5 mCd MIN.

(AT If=2mA)

STORAGE TEMPERATURE: -20° TO 85° C

LEAD SOLDERING TEMPERATURE: 260° C

(5 SEC, 1/16" FROM CASE)

PLATING ON TAILS: TIN OR TIN/COPPER ALLOY OVER SILVER

PRIMARY COLOR FOR BI-COLOR

LEDS IN STANDARD ANODE/

CATHODE CONFIGURATION IS:

RED-GREEN= RED

RED-YELLOW= RED

GREEN-YELLOW= GREEN

GREEN-ORANGE= GREEN

LEGEND

BiC=BI-COLOR LED

LOWC=LOW CURRENT LED

YE=YELLOW

GR=GREEN

RD=RED

OR=ORANGE

NOTE:

THE TWO DIGITS PRECEDING THE ADDITIONAL LED CODE MUST BE USED IN THE PART NUMBER, WHEN ORDERING ANY OF THE ADDITIONAL LED OPTIONS.

DRAWN K. LAMBIE	DATE SEP21/04
DESIGNED	
CHECKED	
I. E. APPRD.	
Q. A. APPRD.	
DWG. APPRD.	
ENG. REL. NO.	
REF.	
DIMENSIONS ARE IN INCHES [mm]	CODE ID. NO. 03554

Amphenol Canada Corp.	
TITLE LED OPTIONS FOR RJHSE, SINGLE OR MULTI-PORT CONNECTORS - RoHS COMPLIANT	
DWG	DRAWING NO. P-RJHSE-LEDS
SCALE	WT. ----- SURF. ----- SHEET 1 OF 1

THIS DOCUMENT CONTAINS PROPRIETARY INFORMATION AND SUCH INFORMATION MAY NOT BE DISCLOSED TO OTHERS FOR ANY PURPOSE OR USED FOR MANUFACTURING PURPOSES WITHOUT WRITTEN PERMISSION FROM AMPHENOL CANADA CORP.