



HDMI Connector A Type

MATERIAL

Insulator : High Temperature Polyester
Contact/Shell : Copper Alloy

SPECIFICATION

Current Rate : 1 AMP
Insulation Resistance : 5000MΩMin. at DC 500V
Contact Resistance : 30mΩMax. at DC 100mA
Operation Temperature : -55°C to +105°C

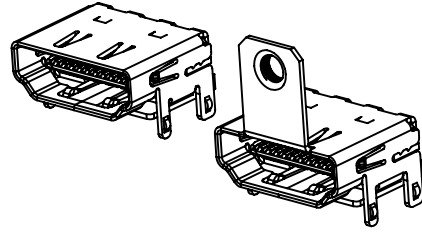

Detail Dimensions

995-11-198xx4

995-11-19Axx4

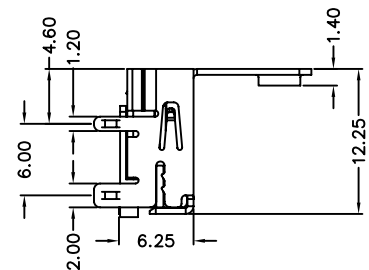
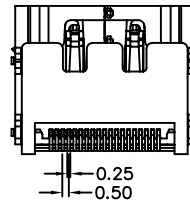
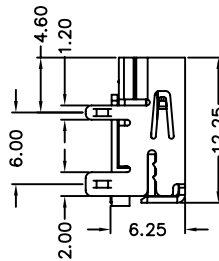
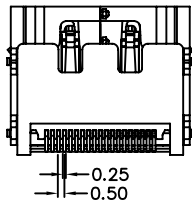
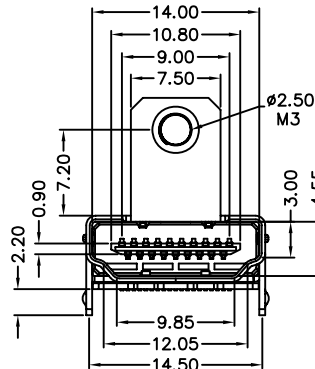
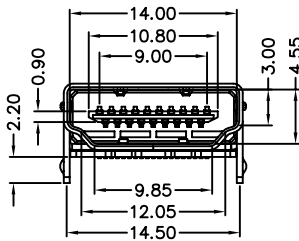
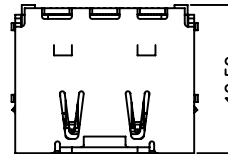
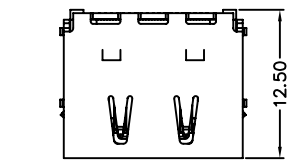

Recommended P.C.B Layout

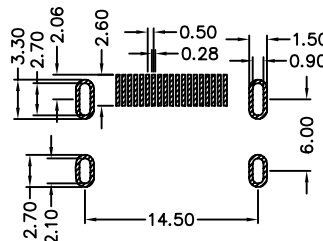
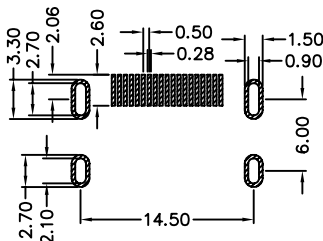

Order Information

995- 1 x - 19 x 0 4 4
1 2 3 4 5

- | | |
|----------------------------|---|
| 1: 1: Tray package | 5. 4: Contact - Gold 0.8u", Matte Tin 100u" |
| 2: Reel package | 6: Contact - Gold 5u", Matte Tin 100u" |
| 2. No. of contacts | 7: Contact - Gold 10u", Matte Tin 100u" |
| 3. 8: without Flange | 8: Contact - Gold 30u", Matte Tin 100u" |
| A: with Flange | |
| 4. 0: Shell - Nickel 100u" | |
| 1: Shell - Gold 0.8u" | |

Unit: mm

Standard Parts
995-11-198044
995-11-19A044