



Model Number

UB2000-F42-E4-V15

Single head system

Features

- **Switch output**
- **Extremely small unusable area**
- **TEACH-IN**
- **Interference suppression (adjustable divergence of sound cone in close range)**
- **Temperature compensation**
- **Synchronization options**
- **NO/NC selectable**

Diagrams

Characteristic response curve

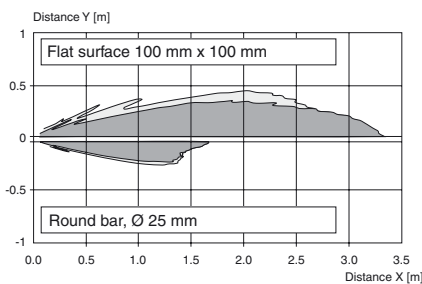

Technical data

General specifications

Sensing range	60 ... 2000 mm
Adjustment range	90 ... 2000 mm
Unusable area	0 ... 60 mm
Standard target plate	100 mm x 100 mm
Transducer frequency	approx. 175 kHz
Response delay	approx. 150 ms

Indicators/operating means

LED green	solid green: Power on
LED yellow	solid: switching state switch output flashing: program function
LED red	normal operation: "fault" program function: no object detected

Electrical specifications

Operating voltage U_B	10 ... 30 V DC , ripple 10 % _{SS}
No-load supply current I_0	≤ 50 mA

Input/Output

Synchronization	bi-directional 0 level: $-U_B \dots +1$ V 1 level: $+4$ V $\dots +U_B$ input impedance: > 12 KOhm synchronization pulse: ≥ 100 μs, synchronization interpulse period: ≥ 2 ms
-----------------	--

Synchronization frequency	≤ 30 Hz
Common mode operation	≤ 30/n Hz, n = number of sensors

Output

Output type	1 switch output E4, NPN, NO/NC, programmable
Rated operational current I_B	200 mA , short-circuit/overload protected
Default setting	Switch point A1: 90 mm , Switch point A2: 2000 mm , wide sound lobe

Voltage drop U_d	≤ 2.5 V
Repeat accuracy	≤ 0.5 % of switching point
Switching frequency f	≤ 2.7 Hz
Range hysteresis H	1 % of the set operating distance
Temperature influence	± 1 % of full-scale value

Ambient conditions

Ambient temperature	-25 ... 70 °C (-13 ... 158 °F)
Storage temperature	-40 ... 85 °C (-40 ... 185 °F)

Mechanical specifications

Connection type	Device connector M12 x 1 , 5-pin
Protection degree	IP54
Material	
Housing	ABS
Transducer	epoxy resin/hollow glass sphere mixture; foam polyurethane, cover PBT
Mass	140 g

Compliance with standards and directives

Standard conformity	
Standards	EN 60947-5-2:2007 IEC 60947-5-2:2007

Approvals and certificates

UL approval	cULus Listed, General Purpose
CSA approval	cCSAus Listed, General Purpose

Release date: 2011-08-16 09:04 Date of issue: 2011-08-16 133986_eng.xml

Dimensions

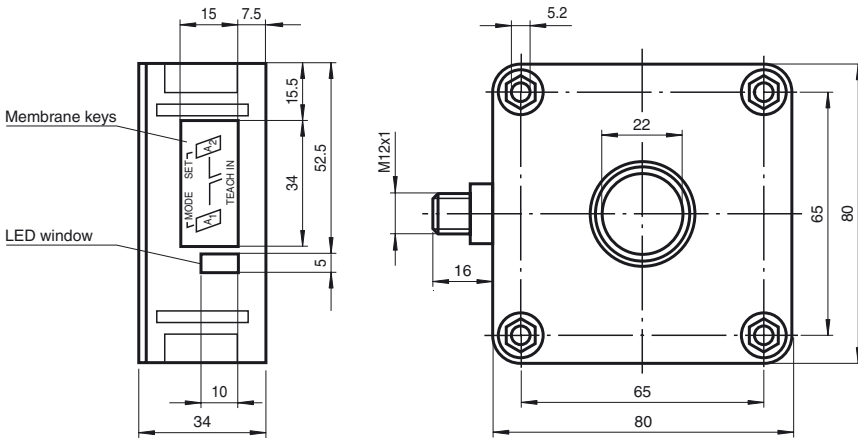

Electrical Connection

Standard symbol/Connections:
(version E4, npn)

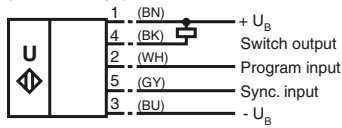

Wire colors in accordance with EN 60947-5-2.

Pinout

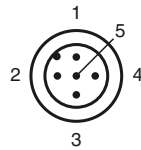

Wire colors in accordance with EN 60947-5-2

1	BN	(brown)
2	WH	(white)
3	BU	(blue)
4	BK	(black)
5	GY	(gray)

Additional Information

Programmable operation modes

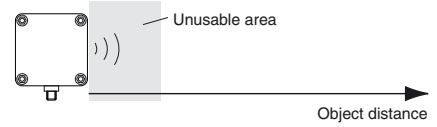

1. Switching point mode

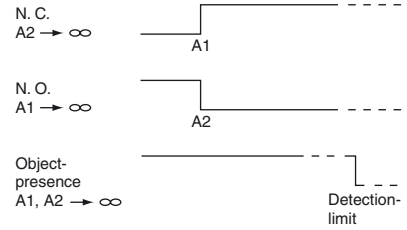

2. Window mode

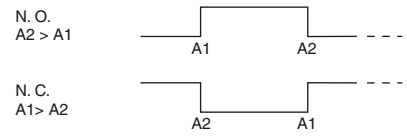

3. Hysteresis mode

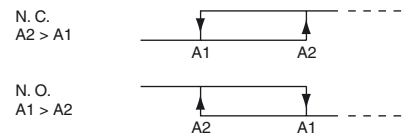

Note:

→ ∞ means: cover transducer surface with your hand, while teaching the switching point.
If A1 = A2, the output works like A2 > A1

Accessories

MH 04-3505

Mounting aid for FP sensors

MHW 11

Mounting brackets for sensors

V15-G-2M-PVC

Cable socket, M12, 5-pin, PVC cable

V15-W-2M-PUR

Cable socket, M12, 5-pin, PUR cable

Functional Description

The sensor may be completely parameterised via two keys on the side panel of the housing. As a special feature provided by this sensor, the ultrasound beam width may be adapted to the environmental conditions at the place of operation of the sensor.

Specifying the switching points:

When specifying the switching points, the user determines at which points the switching output changes its state. The order of the switching points $A1 > A2$, or $A1 < A2$ also determines the direction of action (i.e. normally-closed/normally-open contact function).

Specifying the A1 switching point by pressing the A1 key	
Holding down the A1 key > 2 seconds	The sensor switches to learn mode and the user may specify the A1 switching point
Positioning the target object at the desired distance	The yellow LED of the sensor flashes fast to indicate that the target object has been recognised. The red LED flashes if the object has not been recognised.
Briefly pressing the A1 key	The sensor terminates the specification of the A1 switching point and saves it as a non-volatile value. The specified value is invalid if the object is uncertain (i.e. the red LED lights up at irregular intervals). The learn mode is exited.

The A2 switching point is specified via the A2 key, analogous to the description above.

Alternatively, the switching points may also be specified electrically via the learn input. To specify the A1 switching point, the learn input must be connected to

$-U_B$; to specify the A2 switching point, it must be connected to $+U_B$. Specified values are saved upon the disconnection from the learn input.

Switching points may only be specified directly after Power on. A time lock secures the adjusted switching points against unintended modification 5 minutes after the last keypress. To modify the switching points later, the user may specify the desired values only after a new Power On.

Proceed as follows to parameterise the output function and the ultrasound beam width:

Press the A1 key during Power on and hold down the key for another second to ensure that the sensor starts the two-step parameterisation of the operating modes.

Step 1, parameterisation of the output function

The output function parameterised last is displayed. All output functions available may be selected via consecutive, brief strokes of the A2 key. These strokes are visualised via short flashes of the green LED.

Operating mode	Flash sequence of the green LED	A2 key
1 switching point/ object detection		
Window function (default)		
Hysteresis mode		

Hold down the A1 key for 2 seconds to save the selected output mode, complete the parameterisation and ensure that the sensor returns to normal mode. Step 2 may be initiated by briefly pressing the A1 key (parameterisation of the ultrasound beam width).

Step 2, parameterisation of the ultrasound beam width

In the near range, via Step 2, the ultrasound beam width may be adapted to the requirements of the corresponding application. The beam width parameterised last is displayed first. Available beam width settings may be selected via consecutive, brief strokes of the A2 key. These strokes are visualised via the flash sequence of the red LED.

Beam width	Flash sequence of the red LED	A2 key
Small beam		
Medium beam		
Large beam		

Hold down the A1 key for 2 seconds to save the selected beam shape, complete the parameterisation and ensure that the sensor returns to normal mode. Briefly press the A1 key to return to Step 1 (parameterisation of the output function).

If the parameterisation mode is not terminated within 5 minutes after last keypress (by holding down the A1 key for 2 seconds), the sensor aborts this mode without modifying the settings.

Release date: 2011-08-16 09:04 Date of issue: 2011-08-16 133986_eng.xml

Synchronisation

The sensor has a synchronisation port to suppress mutual influencing. If this port has not been connected, the sensor works at an internally generated cycle rate. Several sensors may be synchronised via the following options.

External synchronisation:

The sensor may be synchronised via the external application of a square wave voltage. A synchronisation pulse on the synchronisation input initiates a measuring cycle. The pulse width must be greater than 100 µs. The measuring cycle is started with the falling edge. A low level > 1 s or an open synchronisation input initiate the transition to normal sensor mode. A high level on the synchronisation input deactivates the sensor.

Two modes are possible:

- Several sensors are controlled via the same synchronisation signal. The sensors work in common mode.
- The synchronisation pulses are forwarded at cyclic intervals to respectively one single sensor. The sensors work in multiplex mode.

Self-synchronisation:

The synchronisation ports of up to 5 sensors suitable for self-synchronisation are connected to each other. These sensors work in multiplex mode after Power on. The On delay increases depending on the number of sensors to be synchronised. While the learn mode is active, no synchronisation is possible (and vice-versa). To specify the switching points, the sensors must be operated in non-synchronised mode.

Note:

If the synchronisation option is not used, the synchronisation input must be connected to ground (0V) or the sensor must be operated with a (4-pole) V1 connecting cable.