



Model Number

IPC03-50P

Data carrier

Features

- Battery-free data carrier
- 32 bit fixcode
- 928 bits computer memory available
- Readable and writable from both sides
- Mounting holes for simple installation
- Protection degree IP68

Dimensions

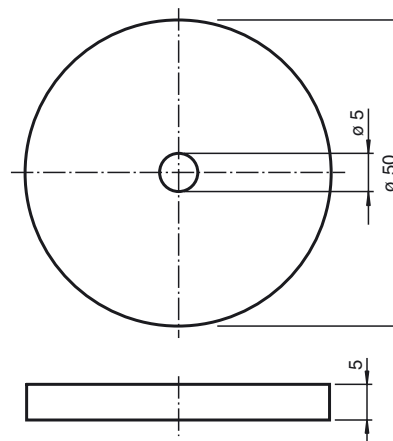

Technical data

General specifications

Operating frequency	125 kHz
Transfer rate	2 kBit/s

Memory

Chip Type	EM4450 Titan (EM Microelectronic)
Type/Size	EEPROM 928 Bit ROM 32 Bit
Read cycles	unlimited
Write cycles	> 100000
Data retention period	10 years at 55 °C (131 °F)

Ambient conditions

Ambient temperature	-25 ... 70 °C (-13 ... 158 °F)
Storage temperature	-40 ... 90 °C (-40 ... 194 °F)

Mechanical specifications

Protection degree	IP68
Material	
Housing	PC (Polycarbonate)
Encapsulation compound	Epoxy

Compliance with standards and directives

Standard conformity	
Protection degree	EN 60529

Notes

The transponder can be read and written from either side.

Read/write distances

- ① IPH-18GM-V1 ③ IPH-F61 ⑤ IPH-FP-V1 ⑦ IPT1-FP-V1
- ② IPH-30GM-V1 ④ IPH-L2-V1 ⑥ IPH-F15-V1

Reading range in air IPC03-50P

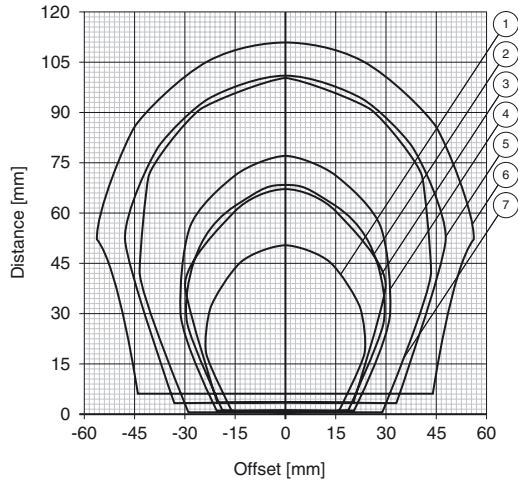

Writing range in air IPC03-50P

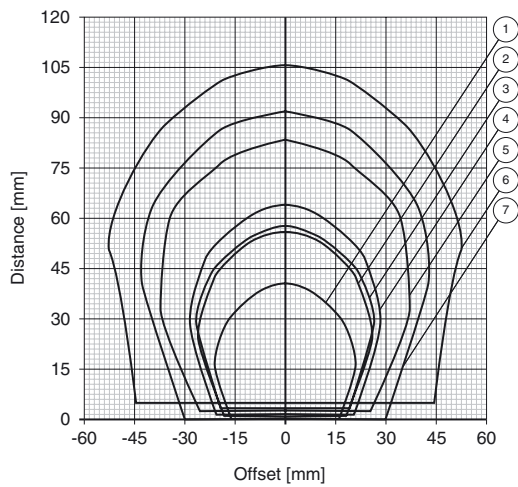

Release date: 2011-07-19 10:02 Date of issue: 2012-02-28 181531_eng.xml

Reading range on aluminium IPC03-50P

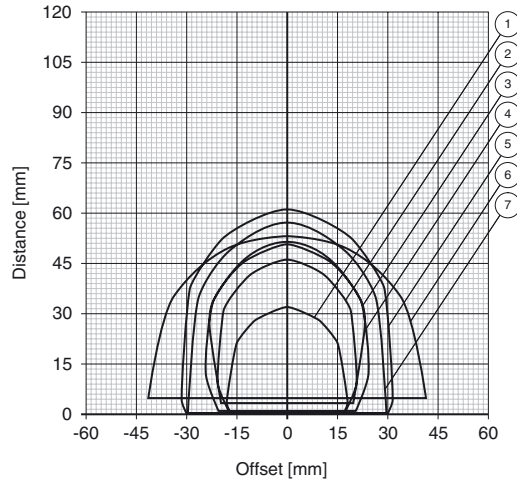

Writing range on aluminium IPC03-50P

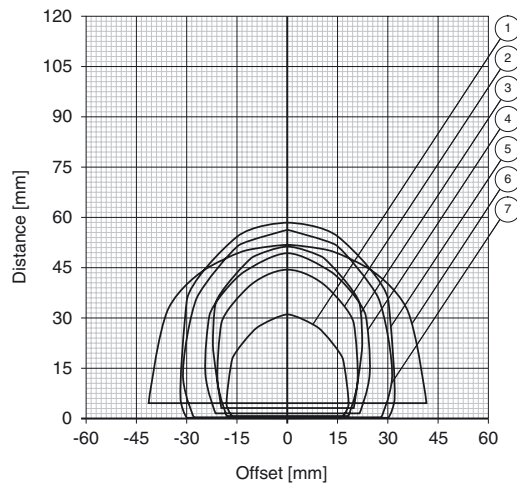

Reading range on steel IPC03-50P

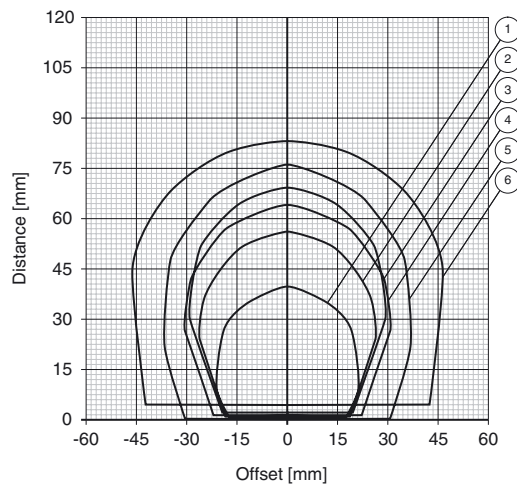

Release date: 2011-07-19 10:02 Date of issue: 2012-02-28 181531_eng.xml

Writing range on steel IPC03-50P

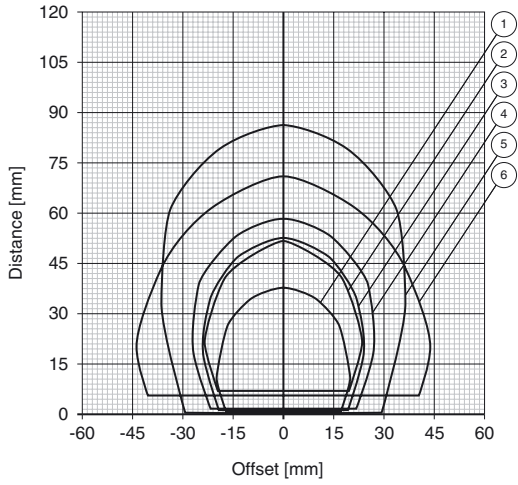

Release date: 2011-07-19 10:02 Date of issue: 2012-02-28 181531_eng.xml