



**Model Number**

**ML100-8-W-200-RT/103/115b**

Diffuse mode sensor  
with 2 m fixed cable and 4-pin, M12 x 1  
connector

**Features**

- Miniature design
- Easy to use
- Very bright, highly visible light spot
- Full metal thread mounting
- Highly visible LEDs for Power ON and switching state
- Not sensitive to ambient light

**Product information**

The ML100 series is characterized by its miniature housing with integral, all-metal threaded bushings. All versions are equipped with a visible red transmitter LED. This greatly simplifies installation and commissioning. The switching states are easily visible from all directions thanks to the highly visible LEDs.

**Dimensions**

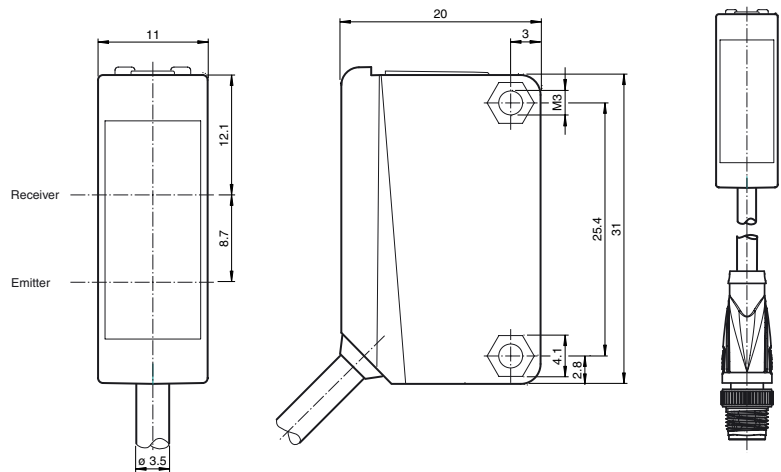

**Electrical connection**

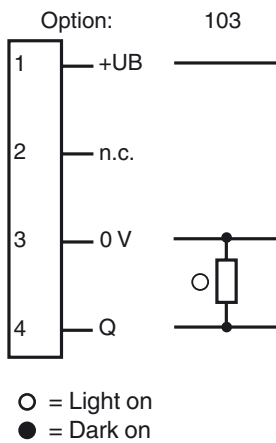

**Pinout**

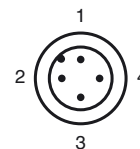

**Indicators/operating means**

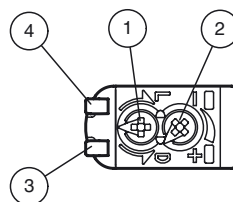

1	Light-Dark-switching	
2	Sensitivity adjuster	
3	Signal display	yellow
4	Operating display	green

Release date: 2013-11-21 10:29 Date of issue: 2013-11-21 235963\_eng.xml

Refer to "General Notes Relating to Pepperl+Fuchs Product Information".

**Technical data****General specifications**

Detection range	0 ... 200 mm
Adjustment range	15 ... 200 mm
Reference target	standard white , 200 mm x 200 mm
Light source	LED
Light type	modulated visible red light
Diameter of the light spot	approx. 170 mm at a distance of 200 mm
Optical face	frontal
Ambient light limit	EN 60947-5-2

**Functional safety related parameters**

MTTF <sub>d</sub>	860 a
Mission Time (T <sub>M</sub> )	20 a
Diagnostic Coverage (DC)	0 %

**Indicators/operating means**

Operation indicator	LED green: power on
Function indicator	LED yellow, lights up with receiver lit
Control elements	sensitivity adjustment
Control elements	Light/Dark switch

**Electrical specifications**

Operating voltage	U <sub>B</sub>	10 ... 30 V DC , class 2
Ripple		max. 10 %
No-load supply current	I <sub>0</sub>	< 20 mA

**Output**

Switching type	light/dark on, switchable	
Signal output	1 PNP output, short-circuit protected, reverse polarity protected, open collector	
Switching voltage	max. 30 V DC	
Switching current	max. 100 mA , resistive load	
Voltage drop	U <sub>d</sub>	≤ 1.5 V DC
Switching frequency	f	1000 Hz
Response time		0.5 ms

**Ambient conditions**

Ambient temperature	-30 ... 60 °C (-22 ... 140 °F)
Storage temperature	-40 ... 70 °C (-40 ... 158 °F)

**Mechanical specifications**

Protection degree	IP67
Connection	300 mm fixed cable with 4-pin, M12 x 1 connector
Material	
Housing	PC (Polycarbonate)
Optical face	PMMA
Mass	approx. 20 g
Cable length	0.3 m

**Compliance with standards and directives**

Directive conformity	
EMC Directive 2004/108/EC	EN 60947-5-2
Standard conformity	
Standards	UL 508

**Approvals and certificates**

UL approval	cULus Listed, Class 2 Power Source, Type 1 enclosure
CCC approval	CCC approval / marking not required for products rated ≤36 V
Approvals	CE, cULus Listed 57M3 (Only in association with UL Class 2 power supply; Type 1 enclosure)

**Accessories**

**OMH-ML100-01**  
Mounting bracket

**OMH-ML100-02**  
Mounting bracket

**OMH-ML100-03**  
Mounting aid for round steel ø 12 mm or sheet 1.5 mm ... 3 mm

**OMH-ML100-04**  
Mounting bracket

**OMH-ML100-05**  
Mounting bracket

**OMH-F10-ML100**  
Mounting aid for ML100 series

**OMH-10**  
Mounting aid

**OMH-ML100-S1**  
Mounting bracket

**V1-G-2M-PUR**  
Female cordset, M12, 4-pin, PUR cable

**V1-W-2M-PUR**  
Female cordset, M12, 4-pin, PUR cable

Other suitable accessories can be found at [www.pepperl-fuchs.com](http://www.pepperl-fuchs.com)

**Curves/Diagrams**

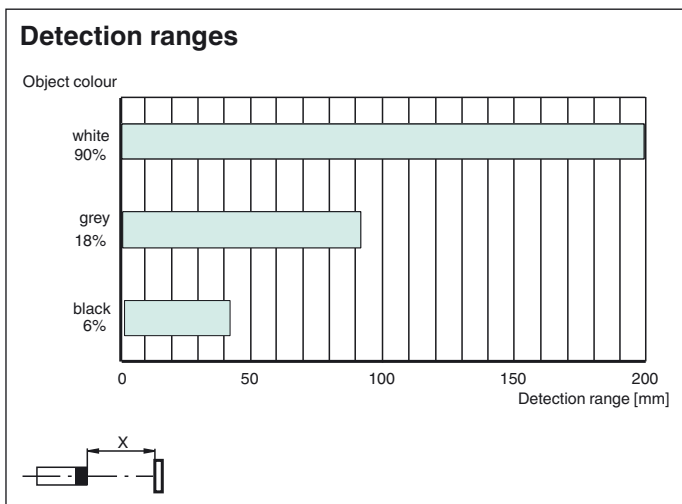
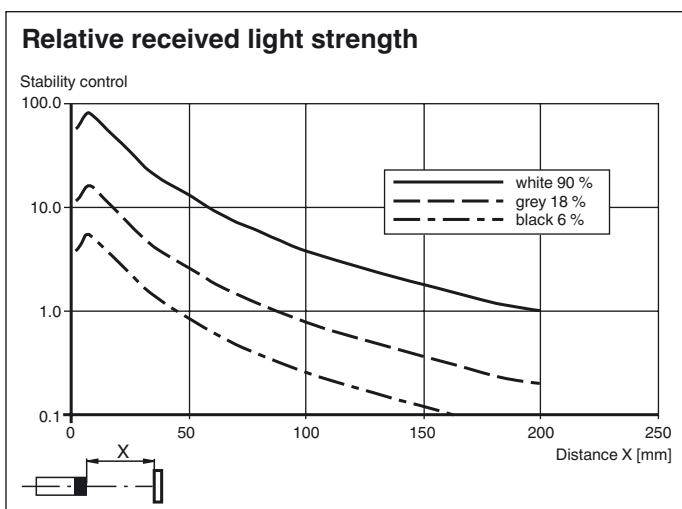
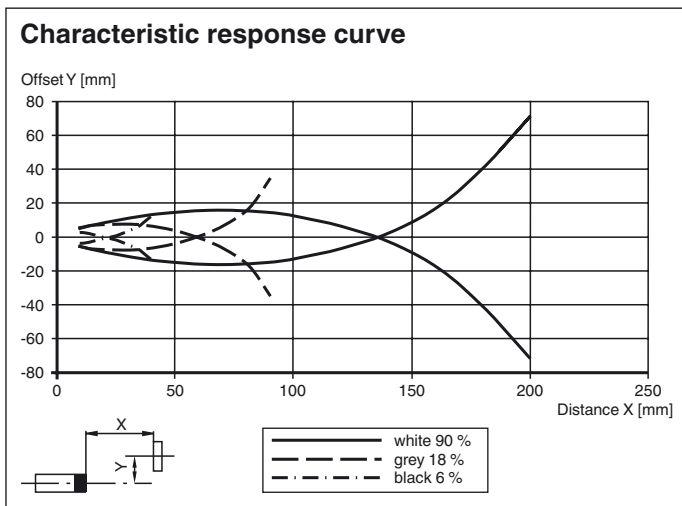

Release date: 2013-11-21 10:29 Date of issue: 2013-11-21 235963\_eng.xml

Refer to "General Notes Relating to Pepperl+Fuchs Product Information".