



### Model Number

#### V1-W-E2-YE5M-PVC-U

Cable socket, M12, LED, 3-pin, PVC cable

### Features

- Built-in LED, as operating and function indicator
- UL Recognized Component
- Knurled nut suitable for tool assembly
- Immunity to vibration, with mechanical latching
- Gold-plated and machined contacts
- Protection degree IP67 / IP68 / IP69K
- Flame resistant cable

### Dimensions

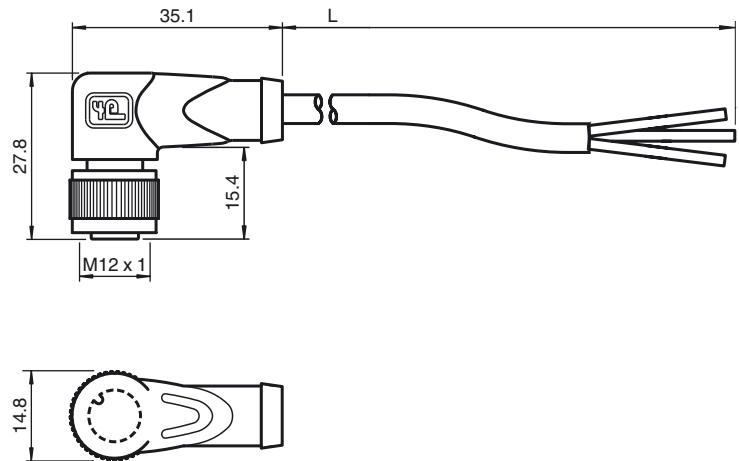

### Technical data

#### General specifications

Number of pins	3
Connection 1	socket
Construction type 1	right angle
Threading 1	M12
Connection 2	cable end
UL File Number	E231213

#### Indicators/operating means

LED green	Operating display
LED yellow	Functional display NO

#### Electrical specifications

Operating voltage	$U_B$	max. 24 V DC $\pm$ 15%
Operating current		max. 4 A
Volume resistance		< 5 m $\Omega$

#### Ambient conditions

Ambient temperature	Body: -40 ... 90 °C (-40 ... 194 °F) cable, flexing: -25 ... 80 °C (-13 ... 176 °F) cable, fixed: -5 ... 80 °C (23 ... 176 °F)
Pollution Degree	3

#### Mechanical specifications

Contact elements	spring-loaded contact socket
Pin diameter	1 mm
Protection degree	IP67 / IP68 / IP69K
Material	
Contacts	CuSn / Au
Contact surface	Au
Body	TPU, transparent
Cable	PVC
Slotted nut	Diecast zinc
Core insulation	PVC
Cable	fine-strand, flexible
Sheath diameter	$\varnothing$ 4.3 mm
Bending radius	> 15 x cable diameter, induced > 5 x cable diameter, fixed
Color	yellow
Cores	3 x 0.34 mm <sup>2</sup>
Conductor construction	19 x 0.15 mm $\varnothing$
Length	L 5 m

#### Flammability

Contact material	HB
Housing	V-2
Cable	FT1

#### Compliance with standards and directives

### Electrical connection

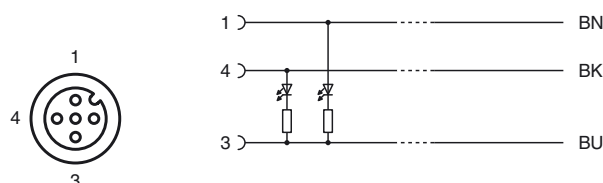



<b>Standard conformity</b>	
Protection degree	EN 60529:2000
Standards	IEC 61076-2-101:2008
Flammability	Body: UL 94 Line: UL 1581 Section 1061; IEC 60332-1-2:2004
<b>Approvals and certificates</b>	
UL approval	cURus AWM 2095 AWM I/II A/B 80°C 300V FT1 (cable)

Release date: 2013-08-14 13:16 Date of issue: 2013-08-14 456407\_eng.xml