

Super-mini Signal Conditioners Mini-M Series

PULSE SCALER

(field-configurable)

Functions & Features

- Converts pulse rate into convenient engineering unit for display on a totalizing counter or meter
- Excitation
- Scaling factor adjustable of 1.0000×10^0 to 0.0001×10^{-6}
- Various outputs (open collector, voltage pulse and AC/DC switch)
- Three-way isolation
- CE marking
- UL approval

Typical Applications

- Positive displacement flowmeters and turbine flowmeters
- Magnetic tachometers

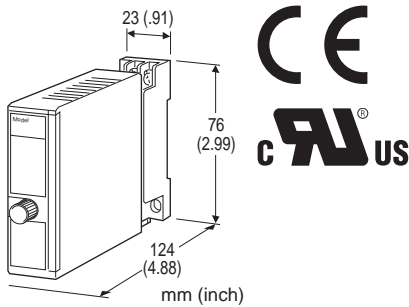

MODEL: M2PRU-[1][2][3]-[4][5]

ORDERING INFORMATION

- Code number: M2PRU-[1][2][3]-[4][5]
- Specify a code from below for each [1] through [5].
(e.g. M2PRU-A24A-M2/CE/Q)
- Scaling factor (e.g. 0.7000×10^{-2})
- Specify the specification for option code /Q
(e.g. /C01/S01)

[1] INPUT

- A1: Open collector
- A2: Mechanical contact
- C: Voltage pulse (sensitivity 2 V)
- H: Two-wire current pulse

[2] EXCITATION

- 4: 12 V DC / 30 mA
- 7: 24 V DC / 30 mA

[3] OUTPUT

- A: Open collector (max. 100 kHz)
- M: 5 V pulse (max. 100 kHz)
- N: 12 V pulse (max. 100 kHz)
- P: 24 V pulse (max. 100 kHz)
- R: AC/DC switch (max. 1 kHz)

[4] POWER INPUT

AC Power

M2: 100 - 240 V AC (Operational voltage range 85 - 264 V, 47 - 66 Hz)
(90 - 264 V for UL)

DC Power

R: 24 V DC
(Operational voltage range 24 V \pm 10 %, ripple 10 %p-p max.)
 R2: 11 - 27 V DC
(Operational voltage range 11 - 27 V, ripple 10 %p-p max.)
(Select '/N' for 'Standards & Approvals' code.)
 P: 110 V DC
(Operational voltage range 85 - 150 V, ripple 10 %p-p max.)
(110 V \pm 10 % for UL)

[5] OPTIONS (multiple selections)

STANDARDS & APPROVALS (must be specified)

- /N: Without CE or UL
- /CE: CE marking
- /UL: UL approval (CE marking)

OTHER OPTIONS

- blank: none
- /Q: Option other than the above (specify the specification)
(UL not available)

SPECIFICATIONS OF OPTION: Q (multiple selections)

COATING (For the detail, refer to M-System's web site.)

- /C01: Silicone coating
- /C02: Polyurethane coating
- /C03: Rubber coating

TERMINAL SCREW MATERIAL

- /S01: Stainless steel

CAUTION

- 1) The M2PRU's output waveform is not uniform due to its scaling method. The user must be aware that it may be inconvenient for certain types of application.
- 2) The M2PRU is designed to accept at the maximum of 100 kHz, which may cause errors due to chattering in the input pulses.

A filter circuitry (time constant: approx. 1 msec.) is incorporated to eliminate unwanted chattering when the mechanical contact input is specified. It is effective for

most relay types, however, an external CR filter as indicated below, could be added if the user need improvement. Limit the input frequency to 10 Hz at maximum.

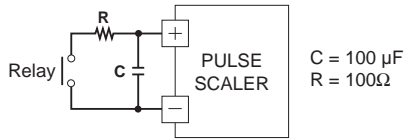

GENERAL SPECIFICATIONS

Construction: Plug-in

Connection: M3 screw terminals (torque 0.8 N·m)

Housing material: Flame-resistant resin (black)

Isolation: Input to output to power

Chattering protection: Filter provided for mechanical contact input (time constant: approx. 1 msec.)

Input pulse sensing: DC coupled; capacitor coupling (automatic trigger*) is field selectable with the side DIP switch for the voltage pulse input.

*Capacitor coupling, with which the detecting levels are automatically set within two peaks of the waveforms, is effective way to detect those with DC offset. However, it may be ineffective if the duty ratio is extremely high or low. The automatic trigger method can compensate such irregular pulses.

Scaling factor adjustment: 10-position rotary switch (front); $1.0000 \times 10^0 - 0.0001 \times 10^{-6}$; factory set to 1.0000×10^0 if not specified when ordering

Output pulse width adjustment: Single-turn screwdriver adjustment (front); 5 µsec. – 400 msec. (one-shot type); Factory set to 5 µsec. except for the mechanical contact input set to 15 msec. or AC/DC switch output set to 500 µsec.

(Min. 400 µsec. recommended for AC/DC switch output of which the internal voltage drop value may increase with a shorter pulse width.)

Output pulse width range selector: Double-throw SW (front)

INPUT SPECIFICATIONS

Excitation: Shortcircuit protection; limited to approx. 40 mA at shortcircuit

• **Open Collector**

Frequency range: 0 – 100 kHz

Pulse width time requirement: Min. 5 µsec. for ON and OFF

Sensing: Approx. 24 V DC @2 mA

Detecting levels: ≤ 400 Ω / 0.8 V for ON,
≥ 1200 Ω / 2.4 V for OFF

• **Mechanical Contact**

Frequency range: 0 – 30 Hz

Pulse width time requirement: Min. 10 msec. for ON and OFF

Sensing: Approx. 24 V DC @2 mA

Detecting levels: ≤ 400 Ω / 0.8 V for ON,

≥ 1200 Ω / 2.4 V for OFF

• **Voltage Pulse**

Waveform: Square or sine

Frequency range: 0 – 100 kHz
(min. 10 Hz for sine waves)

Pulse width time requirement: ≥ 5 µsec. for high and low levels

Input impedance: ≥ 10 kΩ

Max. input voltage across the terminals: ±50 V

Detecting levels

DC coupled: ≥ 2 V DC for high level; ≤ 1 V DC for low level

Capacitor coupled: ≥ 2 Vp-p

• **Two-wire Current Pulse**

Frequency range: 0 – 100 kHz

Pulse width time requirement: Min. 5 µsec. for high and low levels

Detecting levels:

≥ 10 mA for high level

≤ 5 mA for low level

Maximum current: ±30 mA

Input resistance: Receiving resistor 200 Ω

OUTPUT SPECIFICATIONS

• **Open Collector:** 50 V DC @200 mA (resistive load)

Maximum frequency: 100 kHz

Saturation voltage: 0.6 V DC

• **Voltage Pulse**

Maximum frequency: 100 kHz

High level: Rating (5, 12 or 24 V) ±10 %

Low level: ≤ 0.5 V

Load resistance:

≥ 500 Ω for 5 V

≥ 1200 Ω for 12 V

≥ 4800 Ω for 24 V

• **AC/DC Switch:**

132 V AC @200 mA (cos φ = 1)

30 V DC @200 mA (resistive load)

Maximum frequency: 1 kHz

Internal voltage drop: ≤ 3 V

INSTALLATION

Power Consumption

• **AC Power input:**

Approx. 4 VA at 100 V

Approx. 5 VA at 200 V

Approx. 6 VA at 264 V

• **DC Power input:** Approx. 3 W

Operating temperature: -5 to +55°C (23 to 131°F)

Operating humidity: 30 to 90 %RH (non-condensing)

Mounting: Surface or DIN rail

Weight: 150 g (0.33 lbs)

PERFORMANCE

Response time: 25 μ sec. + input cycle + output cycle
(time required for the first pulse to be output from a train of pulse input)

Insulation resistance: $\geq 100 \text{ M}\Omega$ with 500 V DC

Dielectric strength: 2000 V AC @1 minute (input to output to power to ground)

STANDARDS & APPROVALS

CE conformity:

EMC Directive (2004/108/EC)

EN 61000-6-4 (EMI)

EN 61000-6-2 (EMS)

Low Voltage Directive (2006/95/EC)

EN 61010-1

Installation Category II

Pollution Degree 2

Max. operating voltage 300V

Input or output to power: Reinforced insulation

Input to output

Open collector/voltage pulse output: Basic insulation

AC/DC switch output: Reinforced insulation

Approval:

UL/C-UL nonincendive Class I, Division 2,

Groups A, B, C, and D hazardous locations

(ANSI/ISA-12.12.01, CAN/CSA-C22.2 No.213)

UL/C-UL general safety requirements

(UL 61010B-1, CAN/CSA-C22.2 No.1010-1)

EXTERNAL VIEW

FRONT VIEW (with cover open)

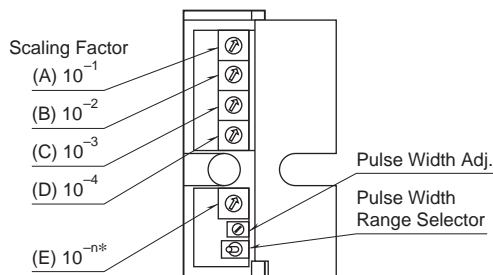

RIGHT SIDE VIEW

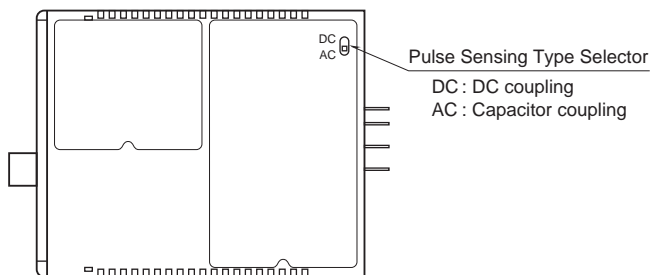

*Settings 7 through 9 are invalid.

No pulse output with these settings.

The front cover cannot be opened to 180 deg.
when flush with neighboring units.

Refer to the instruction manual for detailed procedures.

DIMENSIONS unit: mm (inch)

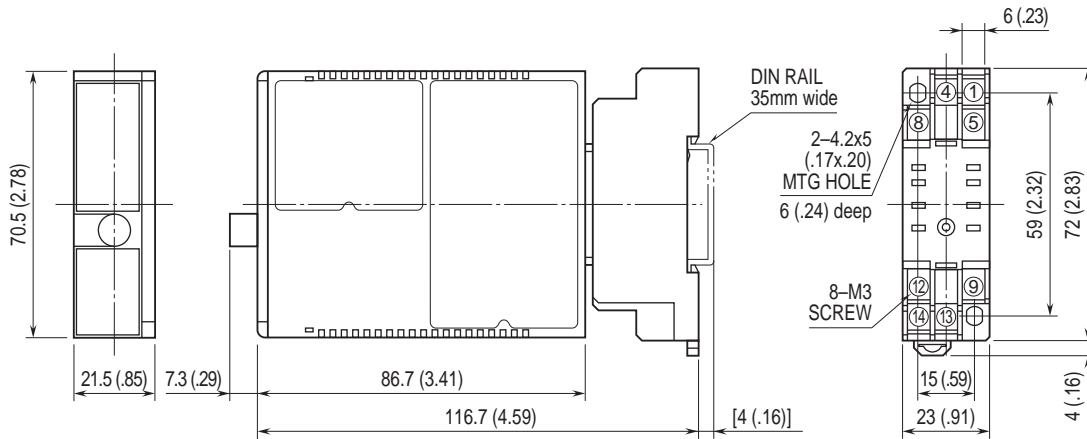

• When mounting, no extra space is needed between units.

SCHEMATIC CIRCUITRY & CONNECTION DIAGRAM

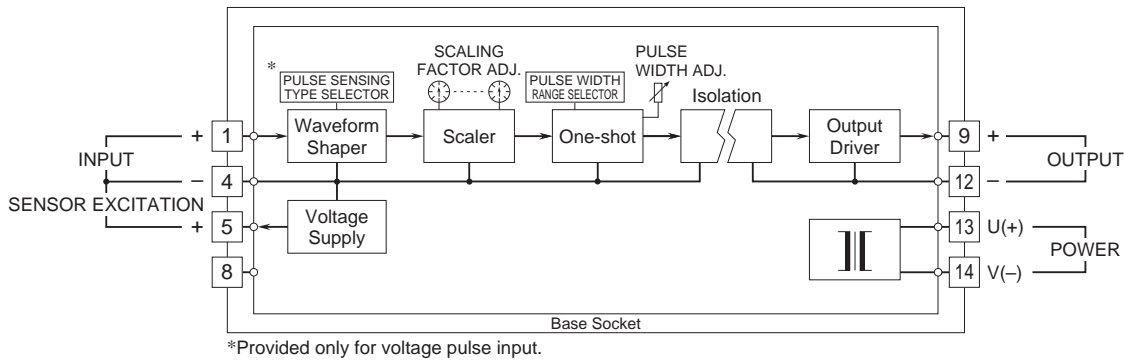

Input Connection Examples

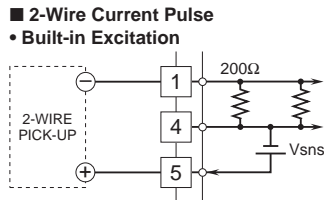
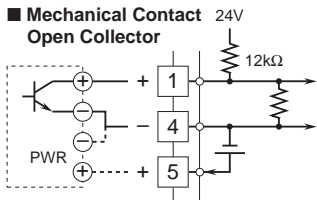

Output Connection Examples

■ Open Collector

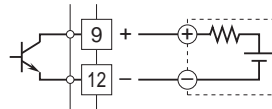

■ Voltage Pulse

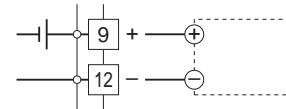

■ Voltage Pulse

• DC Coupled

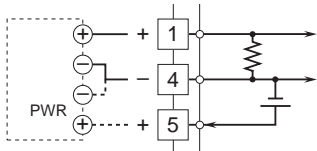

• External DC Supply

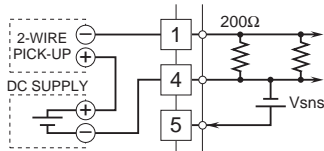

■ AC/DC SWITCH

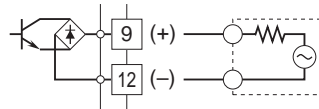

• Capacitor Coupled

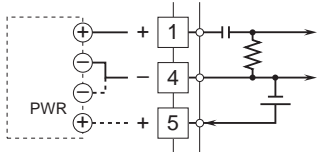

Specifications are subject to change without notice.