

Kunde / customer :

Artikelnummer / part number : **82 381 120 029**

Datum / Date : **2007-04-13**

Bezeichnung :

description : **1206 ESD ULTRA LOW CAP ARRAY 4 TVS**

SMD size: **1206**

ROHS Compliant

A Mechanische Abmessungen / dimensions :

SIZE

(Unit : mm)

Size	W min/max	L min/max	T min/max	a	b min/max
0508	1.05/1.35	1.85 /2.15	0.65/0.80	0.50	0.20/0.30
0612	1.40/1.80	3.00/3.40	0.75/0.95	0.80	0.25/0.55
1206	1.60+/-0.2	3.20+/-0.2	0.50+/-0.1	0.80+/-0.2	0.40+/-0.2

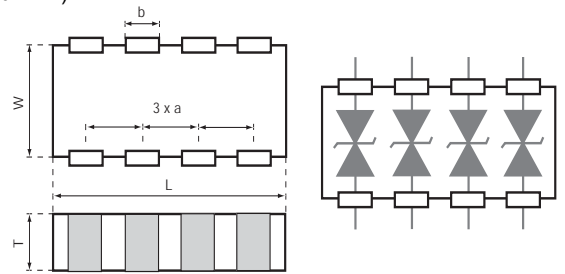

B Elektrische Eigenschaften / electrical properties :

TECHNICAL DATA

Part Number	Working Voltage	Max. Clamping Voltage	Trigger Voltage	Leakage Current	ESD Pulse Withstand	ESD Voltage air discharge	Capacitance
	DC	V (*1)	V	µA (*3)	>100	kV (*4)	µF
82381120029	12	30	150	0.01	>100	+/-15	0.2

- * 1 Max. Clamping Voltage at 8/20 waveform and 1 A pulse current
- * 2 Typ. Clamping Voltage per 8 kV ESD contact discharge method
- * 3 Leakage Current at max operating voltage, the max leakage current was measured at reliability test
- * 4. ESD Typ. Withstands Voltage design and method guarantee this property

Capacitance measured at: **1MHz**

Capacitance/Frequency DC to & 1.8 GHz

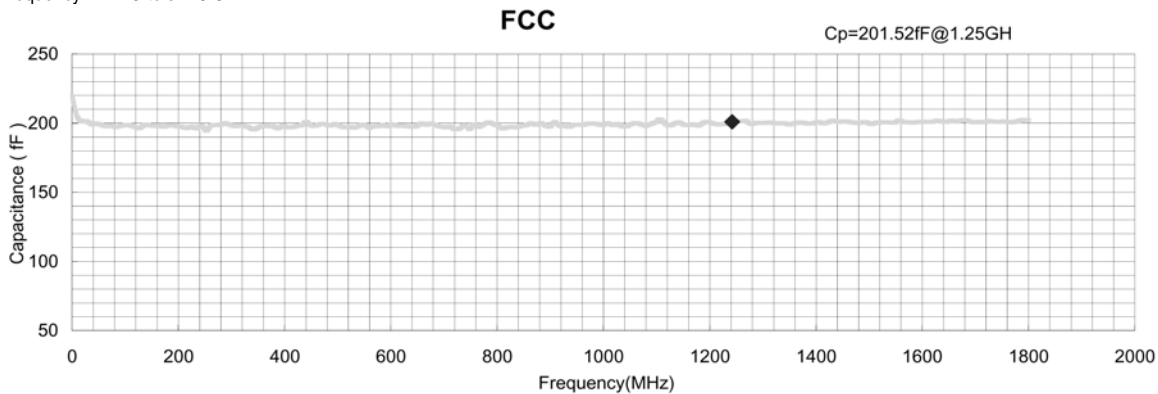

Design and Specifications are subject to change without notice

REFERENCE DATA

Response time	T_{rise}	<	1	ns
Operating ambient temperature			-40~+85	°C
Storage temperature			-50~+125	°C
Max. temperature solder			260/3s	°C

OTHER DATA

Body	Al ₂ O ₃
End termination	Ag/Ni/Sn
Packaging	Reel
Complies with Standard	IEC61000-4-2
Procedure	Solgel
Marking	None

Würth Elektronik eiSos GmbH & Co.KG - Radlalex department

Kunde / customer :

Artikelnummer / part number : 82 381 120 029

Bezeichnung :

description : 1206 ESD ULTRA LOW CAP ARRAY 4 TVS

SMD size: 1206

C Lötpad / soldering spec. :

RECOMMENDED SOLDER PAD LAYOUT

Size	A	B	C	D	E	F
0508	2.10	1.25	0.85	0.35	0.50	1.50
0612	2.60	1.70	0.90	0.50	0.80	2.40
1206	2.60	1.05	0.95	0.40	0.80	2.40

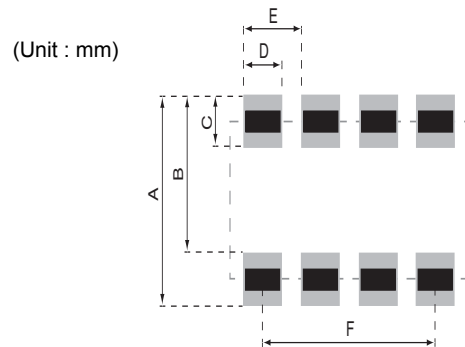

- 1 - The solder paste shall be printed in a thickness of 120 to 180µm.
- 2 - The SIR test of the solder paste shall be done (Based on JIS-Z-3284)
- 3 - IR reflow Pb Free Process suggestin profile (Based on J-STD-020-C):

Rapid heating, partial heating or rapid cooling will easily cause defect of the component. So preheating and gradual cooling process is suggested. IR soldering has the highest yields due to controlled heating rates and solder liquidus times. Make sure that the element is not subjected to a thermal gradient steeper than 3 degrees per second. 2 degrees per second is the ideal gradient. During the soldering process, pre- heating to within 175 degrees of the solders peak temperature is essential to minimize thermal shock.

Soldering recommend paste is Sn 96.5/Ag 3.5

- Preheat
 - 1.The temperature rising speed is suggested to be 2~3°C/s.
 - 2.Appropriate preheat time will be from 60 to 120 seconds.
 - 3.Temp. maintain at 175 +/-25°C 120 seconds.
- Heating
 - 1.Careful about sudden rise in temperature as it may worsen the solder ability.
 - 2.Set the peak temperature in 235°C 10s or 260°C 3s.
- Cooling
 - 1.Ramp down rate 6°C/s max.

※Perform adequate test in advance as the reflow temperature profile will vary according to the conditions of the manufacturing process, and the specification of the reflow furnace

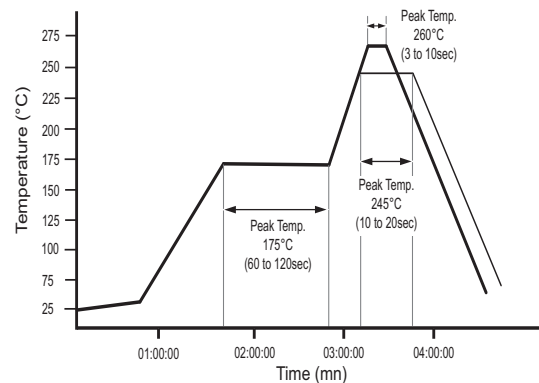

4 - Wave Soldering Process

Ramp-up rate 3°C/s max.
 Temp. maintain at 175 +/-25°C 180 seconds max.
 Peak temperature 260°C 3-10s.
 Ramp down rate 6°C/s max.
 to thermal shock, a preheat is recommended in the soldering process. and the peak temperature should be under controlled rigidly in the solder process.

5 - Hand Soldering Process

Preheating 150°C
 Temperature of soldering iron tip 380°C max. 3 to 5 sec
 The Varistors shall be cooled gradually at room ambient temperature

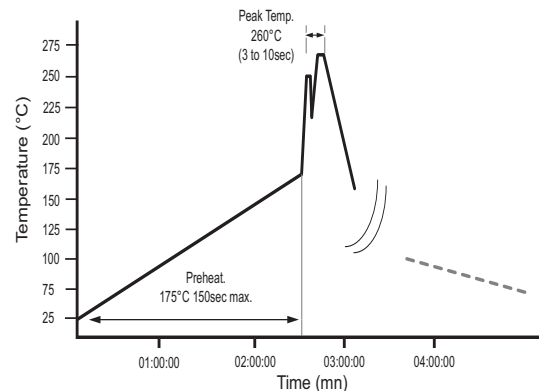

6 - Ultrasonic cleaning

For preventing failures or damages. Frequency 29MHz max - radiated Power 20W/l max - Period 5mn max

Kunde / customer :

Artikelnummer / part number : 82 381 120 029

Bezeichnung :

description : 1206 ESD ULTRA LOW CAP ARRAY 4 TVS

SMD size: 1206

D Rollenspezifikation / tape and reel specification :

- 1 - Carrier tape and transparent cover tape should be heat-sealed to carry the products, and the reel should be used to reel the carrier tape.
- 2 - The adhesion of the heat-sealed cover tape shall be 40 + 20/ - 15grams.
- 3 - Both the head and the end portion of the taping shall be empty for reel package and SMT auto-pickup machine.
And a normal paper tape shall be connected in the head of taping for the operator to handle.

(Unit : mm)

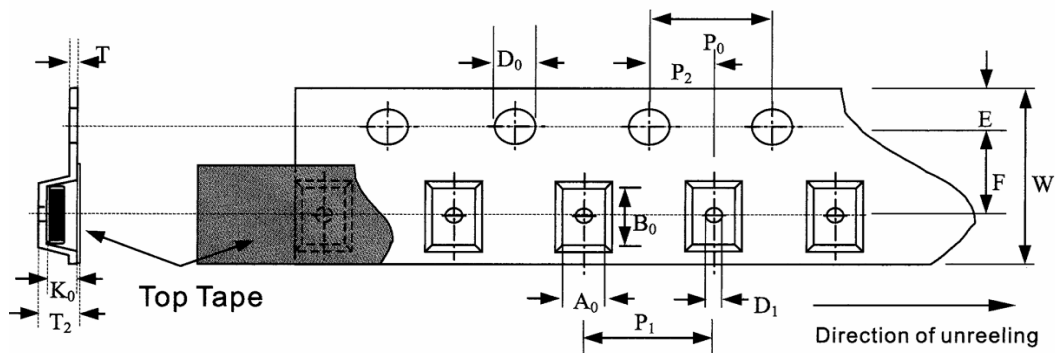

TAPE SPECIFICATION

(Unit : mm)

Symbol	A ₀	B ₀	K ₀	T ₂	T	D ₀	D ₁	P ₁	P ₂	P ₀	W	E	F
	±0.05	±0.05	±0.05	±0.05	±0.05	+0.10	±0.05	±0.10	±0.05	±0.05	±0.20	±0.10	±0.05
						-0.05							
0508	1.50	2.30	-	-	0.75	1.56	-	4.00	2.00	4.00	8.00	1.75	3.50
0612	1.88	3.50	1.27	1.49	0.22	1.50	1.00	4.00	2.00	4.00	8.00	1.75	3.50
1206	1.88	3.50	1.27	0.2	0.10	1.50	1.00	4.00	2.00	4.00	8.00	1.75	3.50

Kunde / customer :

Artikelnummer / part number : 82 381 120 029

Bezeichnung :

description : 1206 ESD ULTRA LOW CAP ARRAY 4 TVS

SMD size: 1206

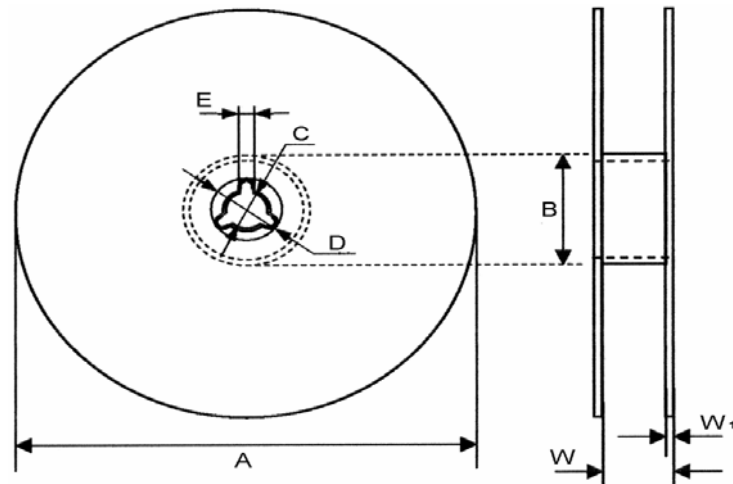
D Rollenspezifikation / tape and reel specification :

REEL DIMENSION

(Unit : mm)

Symbol	A	B	C	D	E	W	W ₁
0508	178.0±1.0	60.0±0.5	13.0±0.2	21.0±0.2	2.0±0.5	9.0±0.50	1.4±0.15
0612	178.0±1.0	60.0±0.5	13.0±0.2	21.0±0.2	2.0±0.5	9.0±0.50	1.5±0.15
1206	178.0±1.0	60.0±0.5	13.0±0.2	21.0±0.2	2.0±0.5	9.0±0.50	1.5±0.15

QUANTITY PER PACKING UNIT

Type	0508	0612	1206
Pcs/reel	4 000	3 000	5 000

Kunde / customer :
 Artikelnummer / part number : **82 381 120 029**
 Bezeichnung :
 description : **1206 ESD ULTRA LOW CAP ARRAY 4 TVS** SMD size: **1206**

E Testbedingungen / test conditions :

BASIC TEST

Characteristics	Test Method/Description
Standard Test Condition	Environmental condition under which every measuring is done without doubt on the measuring results. Unless specially specified, temperature, relative humidity are 5 to 35°C, 45 to 85 % RH.
Max. Working Voltage	Maximum steady-state DC operating voltage the device can maintain and typical leakage current at 25°C not exceed 50 µA.
Varistor Voltage	With the specified measuring current of 1mA DC applied.
Max. Clamping Voltage	Maximum peak voltage across the TVS measured at a specified pulse current (A) and waveform 8/20µs.
Surge Current	Maximum peak current which may be applied with the specified waveform 8/20µs without device failure.
Surge Shift ΔV/V	The shift of TVS voltage after suffering the specified surge current.
Energy Absorption	Maximum energy which may be dissipated with a specified waveform 10/1000µs.without device failure.
Typical Capacitance	Device Capacitance measured with zero voltage bias 0.5VRMS and 1KHZ
Leakage Current	Typical leakage current at 25°C < 50µA

ENVIRONMENTAL RELIABILITY TEST

Characteristic	Test method and description															
High Temperature Storage	The specimen shall be subjected to 150 ± 2°C for 1000 ± 12 hours in a thermostatic bath without load and then stored at room temperature and humidity for 1 to 2 hours. The change of varistor voltage shall be within 10 %.															
Temperature Cycle	The temperature cycle of specified temperature shall be repeated five times and then stored at room temperature and humidity for one or two hours. the change of varistor voltage shall be within 10 % and mechanical damage shall be examined. <table border="1" style="margin-left: 20px;"> <thead> <tr> <th>Step</th> <th>Temperature</th> <th>Period</th> </tr> </thead> <tbody> <tr> <td>1</td> <td>-40±3°C</td> <td>30Min±3</td> </tr> <tr> <td>2</td> <td>Room Temperature</td> <td>1~2 hours</td> </tr> <tr> <td>3</td> <td>125±2°C</td> <td>30Min±3</td> </tr> <tr> <td>4</td> <td>Temperature</td> <td>1~2 hours</td> </tr> </tbody> </table>	Step	Temperature	Period	1	-40±3°C	30Min±3	2	Room Temperature	1~2 hours	3	125±2°C	30Min±3	4	Temperature	1~2 hours
Step	Temperature	Period														
1	-40±3°C	30Min±3														
2	Room Temperature	1~2 hours														
3	125±2°C	30Min±3														
4	Temperature	1~2 hours														
High Temperature Load	After being continuously applied the maximum allowable voltage at 85 ± 2°C for 1000± 2 hours, the specimen shall be stored at room temperature and humidity for one or two hours, the change of varistor voltage shall be within 10 %.															
Damp Heat Load/Humidity Load	The specimen should be subjected to 40 ± 2°C, 90 to 95 % RH environment , and the maximum allowable voltage applied for 1000 hours, then stored at room temperature and humidity for one or two hours. the change of varistor voltage shall be within 10 %															
Low Temperature Storage	The specimen should be subjected to 40 ± 2°C, without load for 1000 hours and then stored at room temperature for one or two hours. the change of varistor voltage shall be within 10 %															

Freigabe erteilt / general release:	Kunde / customer			
Datum / date	Unterschrift / signature			
	Würth Elektronik			
Geprüft / checked	2006-07-31	Kontrolliert / approved	JP. Penlou	
				JP. PENLOU a Size 0.80mm 06-11-24
				JP. PENLOU High Temperature Load 06-07-31
				JP. PENLOU New P/N 2006-06-02
				JP. PENLOU Operating temp. Range 2005-11-30
				JP. PENLOU Lead free soldering 2005-11-04
				Name Änderung / modification Datum / date

Würth Elektronik eiSos GmbH & Co.KG - Radialex department